

T9-SUPER NEO-GLO FISH PELLETT

An absolute fish pellet for neo-glo fish :

- Formulated with special ingredients which will make your Neo-Glo fish glow more brightly.
- Specially selected protein fluorescence, ensuring your Neo-Glo fish shine brilliantly.
- Immune substance added.
- Will not pollute water.
- Suitable for other tropical fish as well.



OFFF1418

OFFF1419

Code No.	Specification	Packing
OFFF1418	Mini Pellet-110ml/60g	60 bottles/carton
OFFF1419	Mini Pellet-280ml/130g	48 bottles/carton

C1-SUPER CICHLID

For large carnivorous fishes that demand high nutrition.

- High nutrition and protein for giant fishes
- Natural color enhancement
- Easy to digest and nutritional content absorbed
- Bigger food stick size
- Suitable for all carnivorous fishes
- Will not cloud water
- Special immune substance added



OFFF505

OFFF504

Code No.	Specification	Packing
OFFF504	Sticks-280ml/90g	48 bottles/carton
OFFF505	Sticks-1100ml/350g	12 bottles/carton

C3-SUPER BLOODPARROT

A superior granules feed for Blood Parrot cichlids.

- Great for colour development
- Head growth development feed
- Nourishing feed to provide vigor and health
- Balance feed for growth and improving body shape
- Special immune substance added
- Healthier and shiner scales after constant feed
- Excellent palatability and easy digestible
- Will not pollute water



OFFF509

OFFF508

OFFF653

Code No.	Specification	Packing
OFFF653	Floating Pellet-20g	360 packets/carton
OFFF508	Floating Pellet-280ml/120g	48 bottles/carton
OFFF509	Floating Pellet-550ml/270g	24 bottles/carton

C4-SUPER CICHLID PELLETT

An absolute color-enhancing pellet feed for all cichlids.

- Balanced feed for growth and improving body shapes
- Great for colour development
- Partial sinking type
- Special immune substance added
- Will not pollute water



OFFF840

OFFF839

OFFF838

OFFF837

Code No.	Specification	Packing
OFFF837	Baby Pellet-110ml/60g	60 bottles/carton
OFFF838	Mini Pellet-280ml/120g	48 bottles/carton
OFFF839	Mini Pellet-550ml/250g	24 bottles/carton
OFFF840	Mini Pellet-1100ml/450g	12 bottles/carton

AQUARIUM

Starter Kit Curve

NEW
ARRIVAL**Setting Up:**

- Clean the tank with paper towels and clean water. Do not use cleaning chemicals as it is harmful for your fishes.
- Place tank on a firm and level surface at your preferred location.
- Rinse gravels and other ornaments with clean water before use.
- Add gravel and setup ornaments as desired.
- Hang the Classica® Crystal Hang-On Filter / G2 on the top of the aquarium glass. It is completely equipped with filter media and immediately ready to use.
- Add water. To avoid disturbing the gravel, use a plastic sheet or an object to reduce the impact.
- Fill the Classica® Crystal Hang-On Filter / G2 chambers with water before turning power on. This will prime the filter and allow it to start drawing water.
- **IMPORTANT.** Remove chlorine from water by adding tap water conditioner according to the recommended dosage.

Includes:

- Scratch Resistant Glass Aquarium
- Decorative Plant
- Hang On Power Filter with Media
- Coloured Gravel
- Rigid Clear Top Cover
- Net

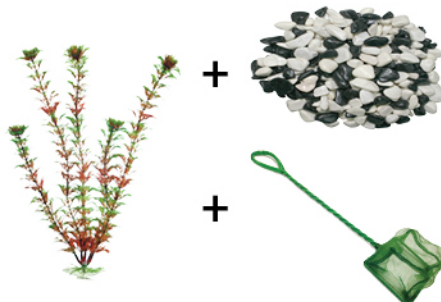

or



Note : Decoration Plant is for illustration only. Actual product may not be the same as shown.

Code No	Volume	Dimension (LxWxH)	Type of Filter	Packing
AT668B	12 Litre	30 x 16 x 24cm	Crystal Hang-On Filter 1	Individual
AT669B	21 Litre	36 x 22 x 26.5cm	Crystal Hang-On G2 Filter 2	Individual
AT670B	30 Litre	40 x 25.5 x 29cm	Crystal Hang-On G2 Filter 2	Individual

NEW
ARRIVAL

FRESHWATER

Hydra⁺



FILTRON



Improved design for freshwater application.

- ✓ Prevents New Tank Syndrome
Verhindert das Neu-Backen-Syndrom
- ✓ Reduces Water Change Frequency
Wasser muss nicht mehr so häufig ausgetauscht werden
- ✓ Produces Crystal-Clear Water
Sorgt für kristallklares Wasser
- ✓ Reduces Water Odours
Verringert modrigen Geruch des Wasser

3X
NITRIFICATION
POWER
* Compared To Classic Conventional
Conventional Filters



REVOLUTIONARY
4STAGE
WATER PURIFICATION
Hydro-Pure Technology |
Mechanical | Biological |
Chemical

READY TO USE
Includes All Essential Filter Media



**FRESHWATER
USE ONLY**

3 YEARS
WARRANTY

* INTERNAL LABORATORY TESTING FIGURES

NOTABLE FEATURES

- **4-Stage Water Purification** | Hydra Filtron's 4-Stage Water Purification, goes beyond the conventional 3 stage filtration (Mechanical, Biological, Chemical), with the incorporation of the revolutionary Hydro-pure Technology that uses Hydroxyl Radicals ($\cdot\text{OH}$) to accelerate the startup time from the usual 4-5 weeks to within 1 week, reduces water odour, and retains a crystal clear tank. The result is a cleaner and healthier aquarium the natural way without any harmful chemical
- **One Pull Priming** | A quick pull and push of the Primer draws water into the canister making it ready to use
- **Valve for Easy Maintenance** | Valve controls at the inlet and outlet pipes eliminate the hassle of dealing with water spills during maintenance
- **Surface Skimmer** | Removes unsightly surface oil film to improve oxygen exchange and increase light penetration at water surface

**REVOLUTIONARY
4STAGE
WATER PURIFICATION**
Hydro-Pure Technology |
Mechanical | Biological |
Chemical

STAGE 4

STAGE 3

STAGE 2

STAGE 1

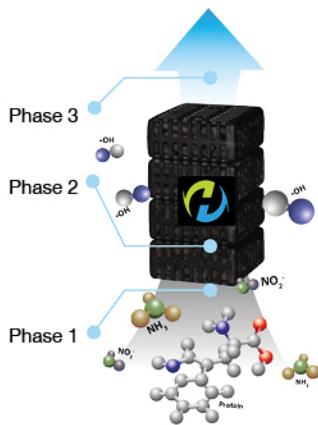

STAGE	DESCRIPTION	FUNCTIONS
STAGE 1	3DM Nuggets	<ul style="list-style-type: none"> Breaks down large solids and traps suspended particles Provides a high surface area for beneficial bacteria which helps break-down toxic waste (e.g. Ammonia and Nitrites) biologically
STAGE 2	Biotrap Sponge	<ul style="list-style-type: none"> Breaks down finer solids and traps suspended particles Provides surface area for beneficial bacteria for further biological purification of toxic waste
STAGE 3	3DM Beads	<ul style="list-style-type: none"> Provides highest surface area for beneficial bacteria which helps break-down toxic waste biologically
	Fine Filter Wool	<ul style="list-style-type: none"> Removes fine particles
STAGE 4	Carbon Pad	<ul style="list-style-type: none"> Absorbs dissolved organic compound and heavy metals to maximize efficiency of the Hydro-Pure Technology
	Hydro-Pure Technology	<ul style="list-style-type: none"> Prevents New Tank Syndrome which is the main cause of fish death in new tanks by constantly breaking down protein, and detoxifying Ammonia (NH₃) and Nitrite (NO₂⁻) Reduces water change. Produces crystal-clear water. Reduces water odours by the oxidization of Sulphur-based elements which causes smell in the water.

Hydro-Pure Technology (The 3 Phases)

Phase 1

- Aquarium water containing Protein, Ammonia (NH₃) and Nitrite (NO₂⁻)

Phase 2

- Cata-pure Media reaction produces reactive Hydroxyl Radicals (•OH) from water

- Hydroxyl Radicals (•OH) reduces Protein, toxic wastes, e.g. Ammonia (NH₃) and Nitrite (NO₂⁻), and odour from Sulphur-based by-products

Phase 3

- Biologically clean and healthy water for fish and invertebrates

TECHNICAL SPECIFICATIONS

MODEL	HYDRA FILTRON 1000	HYDRA FILTRON 1500	HYDRA FILTRON 1800
For Aquarium Size Up To	80 - 300 L 20 - 80 US Gal	150 - 600 L 40 - 160 US Gal	200 - 800 L 50 - 210 US Gal
Product Size	240 x 240 x 363 mm 9.5" x 9.5" x 14.3"	272 x 272 x 403 mm 10.7" x 10.7" x 15.9"	300 x 300 x 443 mm 11.8" x 11.8" x 17.5"
Pump Flow Rate	1000 L/H 270 US Gal	1500 L/H 400 US Gal	1800 L/H 480 US Gal
Circulation Flow Rate	600 L/H 160 US Gal/H	900 L/H 240 US Gal/H	1100 L/H 290 US Gal/H
Filter Media Baskets Volume	4.7 L 1.3 US Gal	7.0 L 1.9 US Gal	10.0 L 2.7 US Gal
Filter Media Baskets	3 pcs	3 pcs	4 pcs
Power Consumption	13 W	23 W	32 W
Inlet & Outlet Hose	ø 16 / 22 mm inner ø 5/8"	ø 19 / 25 mm inner ø 3/4"	ø 19 / 25 mm inner ø 3/4"
Cable Length	2.0 m 78.0"	2.0 m 78.0"	2.0 m 78.0"
Max Height	1.4 m 55.0"	2.0 m 78.0"	2.4 m 94.5"
Cata-Pure Cartridge(s)	2 pcs	3 pcs	4 pcs

Note: Not for use in Marine Water

Code No.	Description	Specification	Power Consumption	Packing
EF0197	Freshwater Hydra Filtron 1000	24cm x 24cm x 36.3cm	13W	2 pieces/carton
EF0198	Freshwater Hydra Filtron 1500	27.2cm x 27.2cm x 40.3cm	23W	2 pieces/carton
EF0199	Freshwater Hydra Filtron 1800	30cm x 30cm x 44.3cm	32W	Individual



FRESHWATER Hydra

AQUATIC DEPURATOR

NEW
ARRIVAL



Breaks Down Protein and Nutrients



Detoxify Ammonia (NH₃) & Nitrite (NO₂)



Create and Maintain Safe and Stable Pristine "Hydro-Pure Water"

3X

NITRIFICATION
POWER

* Compared To Classic Conventional
Conventional Filters

The Hydra is the world's first Aquatic Depurator powered by Hydro-pure Technology, combining it with Biological Filtration into one revolutionary filtration system. The Hydra enhances the natural filtration and detoxification processes by more than 50%. This constant detoxification process results in biologically clean and safe pristine water quality for your fishes, maintains water quality effectively thus reducing frequency of water change.

Note: Not for use in marine water.



IF120

IF121

IF122

IF123

Nozzle attachment.



Usable with hoses
of 12 / 16mm and
16 / 22 mm

The Hydra can be used with small size water features when fitted with the Nozzle attachment.

Code No.	Description	Specification	Power Consumption	Cata-pure	Packing
IF120	Freshwater Hydra 20	For Tank Between 50 - 100 L (400 L/H)	6W	1 piece	12 pieces/carton
IF121	Freshwater Hydra 30	For Tank Between 100 - 200 L (600 L/H)	7.5W	1 piece	12 pieces/carton
IF122	Freshwater Hydra 40	For Tank Between 200 - 500 L (800 L/H)	10W	2 pieces	12 pieces/carton
IF123	Freshwater Hydra 50	For Tank Between 500 - 800 L (1000 L/H)	15W	2 pieces	12 pieces/carton

FRESHWATER Hydra STREAM



AQUATIC DEPURATOR

**NEW
ARRIVAL**



3X

**NITRIFICATION
POWER**

* Compared To Classic Conventional
Conventional Filters

✓ Breaks Down Protein and Nutrients

✓ Detoxify Ammonia (NH₃) & Nitrite (NO₂-)

✓ Create and Maintain Safe and Stable Pristine "Hydro-Pure Water"

The Hydra Stream is the world's first Aquatic Depurator powered by Hydro-pure Technology. It greatly improves your existing aquatic filtration system by enhancing the natural filtration and detoxification processes by more than 50%. This constant detoxification process results in biologically clean and safe pristine water quality for your fishes, maintains water quality effectively thus reducing frequency of water change.

Note: Not for use in marine water.



EF147 / EF150



EF148 / EF151



EF149 / EF152

Set-up Illustration

Suction Cup or
Hang On (optional)



Internal Filter



Top Trickle Filter

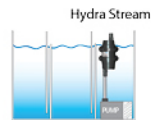

Sump Tank

Suction Cup or
Hang On (optional)



Hobby Pump

Suction Cup or
Hang On (optional)



Hobby Pump



Hydra Stream
External
Filter

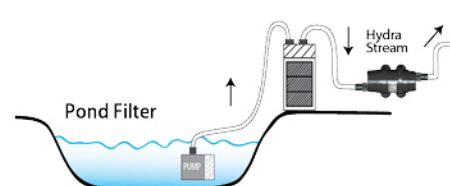

Pond Filter

Code No.	Description	Specification	Power Consumption	Cable Length	Cata-pure	Packing
EF147	Freshwater Hydra Stream 1	For Tank <300 (300 - 1000 L/H)	1.1W	1.5m	4 pieces	12 pieces/carton
EF148	Freshwater Hydra Stream 2	For Tank <600 (500 - 2000 L/H)	1.3W	1.5m	6 pieces	12 pieces/carton
EF149	Freshwater Hydra Stream 3	For Tank <1000 (800 - 3000 L/H)	1.5W	1.5m	8 pieces	12 pieces/carton
EF150	Freshwater Hydra Stream 1	For Tank <300 (300 - 1000 L/H)	1.1W	5m	4 pieces	12 pieces/carton
EF151	Freshwater Hydra Stream 2	For Tank <600 (500 - 2000 L/H)	1.3W	5m	6 pieces	12 pieces/carton
EF152	Freshwater Hydra Stream 3	For Tank <1000 (800 - 3000 L/H)	1.5W	5m	8 pieces	12 pieces/carton

SMART ALERT

POWER FILTER



Alert LED Light-up
Notification



3 Stage
Filtration



Freshwater &
Marine

**NEW
ARRIVAL**



EF0202



EF0203



EF0204

Introduction

Maintenance of Aquatic filtration just got easier now. With our patented Smart Alert Technology, you get a visible LED light-up notification when the mechanical filtration cartridge is almost full. No more forgetting to clean up the filtration. Simply remove the Mechanical Filter Cartridge and replaced with a new one. The separate biological cartridge ensures long term active nitrifying bacteria colonies are maintained when new mechanical filter cartridge is changed out.

Features

- Smart Alert LED light-up notification, signals the need to change the Mechanical Filter Cartridge.
- Complete 3-stage Mechanical, Chemical and Biological phase for the ultimate filtration performance. An individual biological cartridge helps to maintain active nitrifying bacteria colonies for continuous nitrification to remove toxic ammonia and nitrites.
- Noise reduction design using silicon cushioned motor impeller, together with a filter top cover, ensures whisper-silent power filtering operation well below 40dB!
- Extendable intake pipe and adjustable flow rate allows flexible application for every kind of filtration setup, ensuring optimum and effective operation.
- Suitable for both Freshwater and Marine aquarium application.

Specifications

Code No.	Description	Flowrate	Total Power	Packing
EF0202	Smart Alert Power Filter 400	400L/H	4W	12 pieces/carton
EF0203	Smart Alert Power Filter 800	800L/H	6W	12 pieces/carton
EF0204	Smart Alert Power Filter 1200	1200L/H	8W	12 pieces/carton

Components

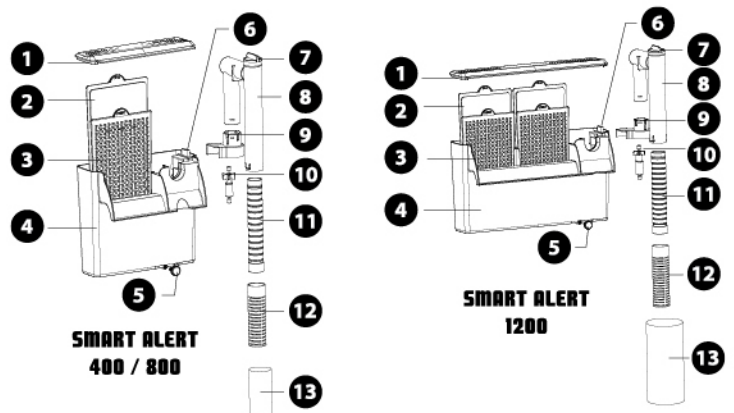

- | | | |
|---|--|-----------------------|
| 1. Cover | 5. Leveling Knob | 9. Impeller Cover |
| 2. Mechanical and Chemical Filter Cartridge | 6. Cartridge Replacement LED Indicator | 10. Impeller |
| 3. Biological Substrate Filter Cartridge | 7. Flowrate Adjustor | 11. Extension Tube |
| 4. Filter Body | 8. Intake Tube | 12. Strainer |
| | | 13. Pre-filter sponge |

RAPTOR SUBMERSIBLE FILTER

- DURABLE
- ENERGY SAVING
- SILENT
- STRONG PERFORMANCE

Features

- Mechanical & Biological Filtration. Special biological coarse black filter sponge (ideal for nurturing beneficial bacteria)
- Easy to upgrade. Capable of adding extra filter cartridge for better performance.
- Multi-use. Can be used as internal filter or powerhead.
- Easy to use. Removable parts for easy maintenance.
- Reliable, Powerful and Silent. For freshwater and marine.

Applications

- Improves water circulation within main tank to minimize dead spots within the tank and enhances aeration.
- Creates water current for fishes that require stronger water flow.
- Can be used together with under-gravel filters and for water transfer.
- For freshwater and marine aquarium, terrarium and small ponds.



Code No.	Specification	Max Flow (L/H)	Max Height (M)	Power Consumption	Packing
IF108	Raptor F-3000	300	0.65	1.8W	96 pieces/carton
IF109	Raptor F-7500	750	0.85	6.0W	48 pieces/carton
IF110	Raptor F-9500	950	1.20	10.0W	48 pieces/carton
IF111	Raptor F-12000	1200	1.40	15.0W	36 pieces/carton
IF112	Raptor F-16000	1600	1.85	22.0W	36 pieces/carton
IF113	Raptor F-24000	2400	2.20	25.0W	24 pieces/carton

MULTI-BIO FOAM FILTER

NEW ARRIVAL



Suitable for

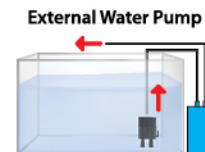
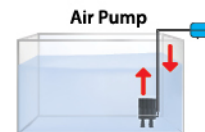

Submersible Water Pump



Overhead Filter

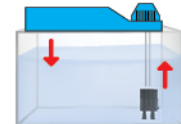

Introduction

Classica® Premium Multi-Bio Foam Filter MB1 is a versatile underwater aquarium filter designed for aquarium tank application, suitable for all fishes and shrimps keeping. It can be driven by an Air Pump or Water Pump. The water is first filtered through a durable multi-Dimensional Bio Foam that provides maximum filtration surface area and easy to wash. Secondly, the water passed through special high-porosity Bio Beads that is an ideal medium for beneficial nitrification bacteria colonies to thrive and biologically remove harmful ammonia and nitrite, thus creating safe and clean water. Classica® Premium Multi-Bio Foam Filter, your best choice in aquarium filtration.

Features

- Multi-dimensional Bio Foam design for maximum filtering
- Efficient and Fast-acting Bio Beads Filter Media
- Biologically remove Ammonia and Nitrite toxins
- Wide application to suit any aquarium tank setup
- Easy Maintenance and Cleaning

Code No.	Description	Suitable for Aquarium	Packing
AF0078	Multi-Bio Foam Filter MB1	≤50L	95 pieces/carton
AF0079	Multi-Bio Foam Filter MB2	≤80L	80 pieces/carton

EVO

PLUS

NEW ARRIVAL



Submersible Water Pump

Key Features

- **Innovative Flow Selector** lets user adjust the flow rate and intake suction zone (side intake or bottom intake), without removing pump or changing parts!
- The pump body and all assembly parts in contact with the working environment are made of materials that can withstand acids and saline-alkalis.
- Low electric power consumption and long usage life achieved with durable motor and ceramic rotor shaft design for silent smooth operation.
- Comes with spare attachments of different outlet pipe size to support different hose tubing size.



Innovative Flow Selector

Bottom Intake



Side Intake



Applications

- Suitable for use as aquarium filter sump water pump, pond fountain pump, general water pump for channeling water...etc.
- Can be used as a water circulation pump in aquaculture farming ponds.
- Can be used as a water pump for watering plants or spray cleaning.
- Suitable for both saltwater and fresh water applications.

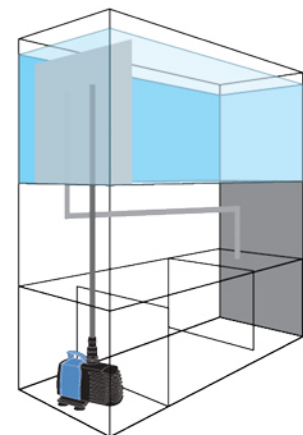
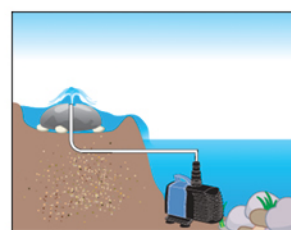
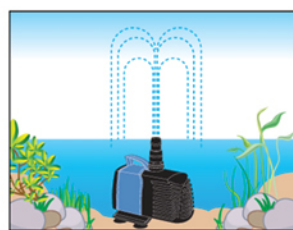
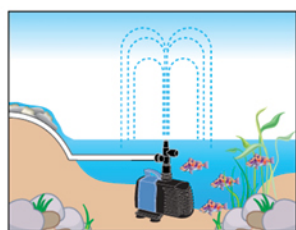

Flowrate

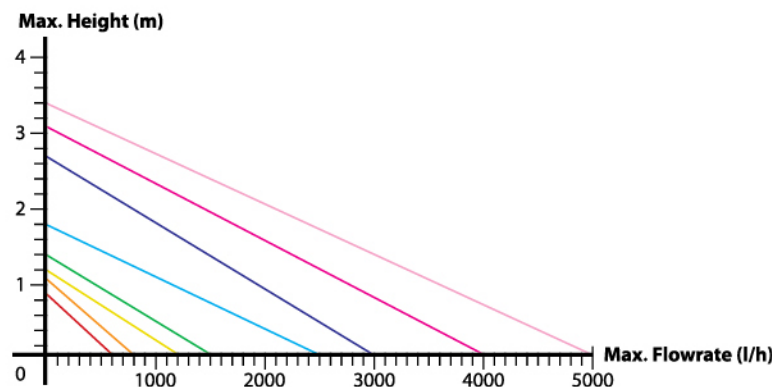

EVO Plus Model

- 600
- 800
- 1200
- 1500
- 2500
- 3000
- 4000
- 5000

This table serves as a general reference and attempts to present data as accurately as possible. Actual results may vary depending on conditions at place of installation.

Components



EVO Plus 600 / 800

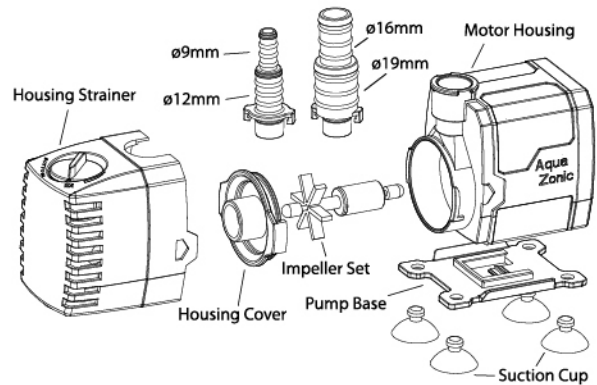

EVO Plus 1200 / 1500

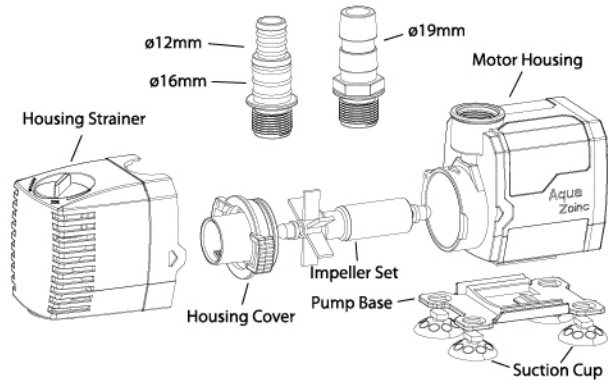

**EVO Plus 2500 / 3000
4000 / 5000**

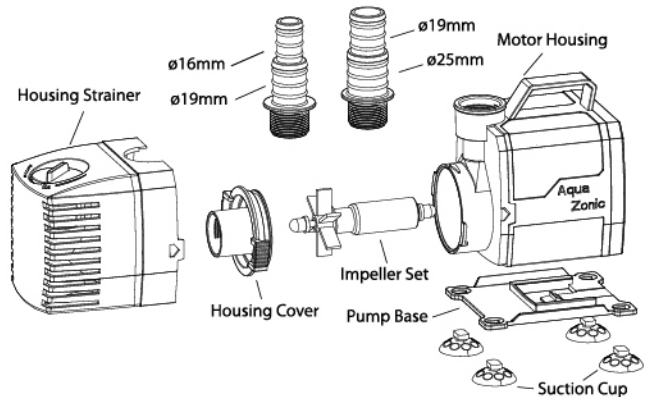

Specifications

Code No.	Description	Max Flowrate	Max Head	Total Power	Inlet Size	Packing
PH0167	Evo Plus 600	600L/H	1.0m	7.5W	ø9, ø12, ø16, ø19mm	36 pieces/carton
PH0168	Evo Plus 800	800L/H	1.3m	10.5W	ø9, ø12, ø16, ø19mm	36 pieces/carton
PH0169	Evo Plus 1200	1200L/H	1.5m	17W	ø12, ø16, ø19mm	24 pieces/carton
PH0170	Evo Plus 1500	1500L/H	2.0m	20W	ø12, ø16, ø19mm	24 pieces/carton
PH0171	Evo Plus 2500	2500L/H	3.0m	32W	ø16, ø19, ø25mm	12 pieces/carton
PH0172	Evo Plus 3000	3000L/H	4.0m	45W	ø16, ø19, ø25mm	12 pieces/carton
PH0173	Evo Plus 4000	4000L/H	5.0m	90W	ø16, ø19, ø25mm	6 pieces/carton
PH0174	Evo Plus 5000	5000L/H	5.5m	120W	ø16, ø19, ø25mm	6 pieces/carton

SMART LINK

RGBW-LED

Slim Series



SMART APP CONTROL



Product Description

The Aqua Zonic® SMART LINK RGBW-LED Slim Series is a highly versatile and smart lightset that can achieve True "Full Spectrum" effect for all kinds of aquarium setup and tropical fishes. The lightset comes with a Wi-Fi communicator unit which can be linked to any Wi-Fi enabled mobile device via the TUYA Smart IoT App to access the full control of the LED color settings and Timer control. The lightset is designed with the latest high-power energy saving RGBW LED chips, it provides a richer color palette so you can achieve more complex forms of color mixing, therefore providing more options for brightness and color tones for more precise performance. With each RGBW LED chip spaced out evenly across the lightset, it can achieve an incredible uniform light coverage and light penetration across the whole aquarium tank. With the flexible color control, RGBW LED chip can achieve a higher Color Rendering Index (CRI), so the lights reflect the colors of objects purely, giving higher color reproduction of your beautiful aquarium.

Features



SMART APP CONTROL

Lightset can be linked with Wi-Fi enabled mobile devices via TUYA Smart IoT App to access full control of the LED color settings and Timer control.



FULL COLOR SPECTRUM ADJUSTABLE

True "Full Spectrum" can be achieved with each individual Red, Green, Blue and White LED.



HIGH-POWER ENERGY SAVING LED

RGBW 4-in-1 LED chip provides brighter and richer color palette, more color tones, high-definition uniform color mixing and higher CRI.



BRIGHTNESS ADJUSTABLE

After desired color spectrum has been selected, the brightness of the overall color can be easily adjusted.



6 PROFESSIONAL PRESET COLOR SPECTRUMS

The App provides professionally optimized color spectrum preset for Tropical Fish, Discus Fish, Planted Tank, Crystal Red Shrimp, Luminous Fish and General Daylight so that the user can easily start using them right away.



LIGHTING TIMER

The App allows user to select the desired automatic light on and light off time setting.

Components

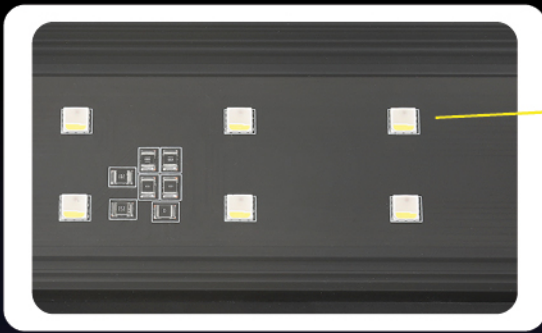

RGBW-LED

LED CHIP

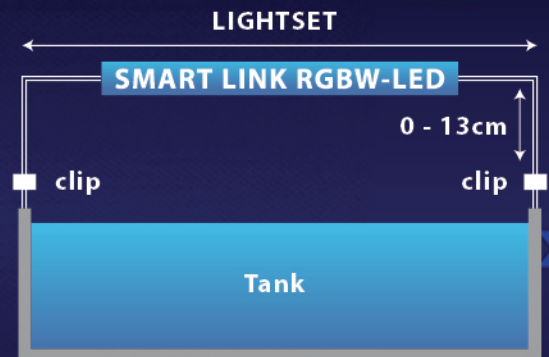
POWER ADAPTER &
CONTROLLER INCLUDEDLAMP HOLDER
INCLUDED

Specification

Model	AL0622	AL0623	AL0624	AL0625	AL0626	AL0627	AL0628
Power (Watt)	15W	20W	30W	44W	59W	74W	88W
No. of RGBW LED chip	18pcs	24pcs	36pcs	54pcs	72pcs	90pcs	108pcs
Lightset Mounting Adjustable Range	L30 - 35cm / H13cm	L45 - 50cm / H13cm	L60 - 65cm / H13cm	L90 - 95cm / H13cm	L120 - 125cm / H13cm	L150 - 155cm / H13cm	L180 - 185cm / H13cm
Suitable Aquarium Size	1ft Tank	1.5ft Tank	2ft Tank	3ft Tank	4ft Tank	5ft Tank	6ft Tank
Cable Length	1.5m	1.5m	1.5m	1.5m	1.5m	1.5m	1.5m
Packing	12pcs/ctn	12pcs/ctn	12pcs/ctn	12pcs/ctn	12pcs/ctn	6pcs/ctn	6pcs/ctn



Tuya Smart



SMART LINK SUBMERSIBLE

RGBW-LED

For AROWANA & Tropical Fish



**SMART APP
CONTROL**



RGBW

Product Description

The Aqua Zonic® SMART LINK SUBMERSIBLE RGBW-LED for arowana and tropical fish is a highly versatile and smart lightset that can achieve True "Full Spectrum" effect for all kinds of aquarium setup and tropical fishes. The lightset comes with a Wi-Fi communicator unit which can be linked to any Wi-Fi enabled mobile device via the TUYA Smart IoT App to access the full control of the LED color settings and Timer control. The lightset is designed with the latest high-power energy saving RGBW LED chips, it provides a richer color palette so you can achieve more complex forms of color mixing, therefore providing more options for brightness and color tones for more precise performance. With each RGBW LED chip spaced out evenly across the lightset, it can achieve an incredible uniform light coverage and light penetration across the whole aquarium tank. With the flexible color control, RGBW LED chip can achieve a higher Color Rendering Index (CRI), so the lights reflect the colors of objects purely, giving higher color reproduction of your beautiful aquarium.

Features



SMART APP CONTROL

Lightset can be linked with Wi-Fi enabled mobile devices via TUYA Smart IoT App to access full control of the LED color settings and Timer control.



FULL COLOR SPECTRUM ADJUSTABLE

True "Full Spectrum" can be achieved with each individual Red, Green, Blue and White LED.



HIGH-POWER ENERGY SAVING LED

RGBW 4-in-1 LED chip provides brighter and richer color palette, more color tones, high-definition uniform color mixing and higher CRI.



BRIGHTNESS ADJUSTABLE

After desired color spectrum has been selected, the brightness of the overall color can be easily adjusted.



6 PROFESSIONAL PRESET COLOR SPECTRUMS

The App provides professionally optimized color spectrum preset for Violet Fusion Red Arowana, Chilli Red Arowana, Golden Crossback Arowana, Green Base Arowana, Tanning and Soft Tanning so that the user can easily start using them right away.



LIGHTING TIMER

The App allows user to select the desired automatic light on and light off time setting.

Components

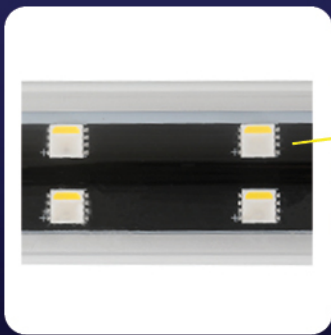

RGBW-LED

LED CHIP

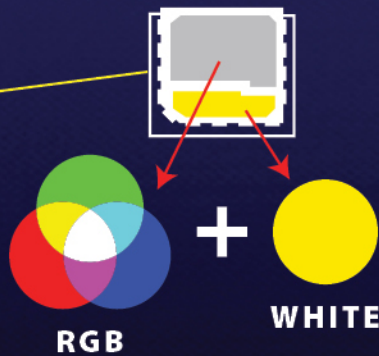

POWER ADAPTER & CONTROLLER INCLUDED

Specification

Model	WL0153	WL0154	WL0155
Power (Watt)	30W	44W	59W
No. of RGBW LED chip	36pcs	54pcs	72pcs
Lightset Dimension	56cm	86cm	115cm
Suitable Aquarium Size	2 ft tank	3 ft tank	4 ft tank
Cable Length	2.8m	2.8m	2.8m
Packing	6pcs / ctn	6pcs / ctn	6pcs / ctn



Tuya Smart



EVO SLIM LED

**NEW
ARRIVAL**



RGB

FEATURES

- **Easy to Install** - Extendable Leg and Clamp (included) allow the light to be easily mounted.
- **Energy Saving** - Low electrical consumption, greater energy savings!
- **Beautiful Colours** - Featuring of 'RGB' LED that displays your tank in full color spectrum. Tropical Red that further enhances red colours.
- **Cool** - Low heat emission compared to other light forms.



SPECIFICATIONS

Code No.	Description	Length	LED	LED (pcs)	Total Power	Packing
AL0640	Evo Slim LED RGB	30cm	RGB	12	10W	24 pieces/carton
AL0641	Evo Slim LED RGB	36cm	RGB	15	12W	24 pieces/carton
AL0642	Evo Slim LED RGB	45cm	RGB	21	17W	24 pieces/carton
AL0643	Evo Slim LED RGB	60cm	RGB	24	20W	24 pieces/carton

Power Input : 100V - 260VAC / 50Hz-60Hz | Power Output : +12VDC

DOUBLE LED

**NEW
ARRIVAL**



RGB

Double the brightness, double the coverage!

FEATURES

- **Easy to Install** - Extendable Leg and Clamp (included) allow the light to be easily mounted.
- **Energy Saving** - Low electrical consumption, greater energy savings!
- **Beautiful Colours** - Featuring of 'RGB' LED that displays your tank in full color spectrum. Tropical Red that further enhances red colours.
- **Cool** - Low heat emission compared to other light forms.



SPECIFICATIONS

Code No.	Description	Length	LED	LED (pcs)	Total Power	Packing
AL0644	Evo Slim Double LED RGB	60cm	RGB	36	25W	12 pieces/carton
AL0645	Evo Slim Double LED RGB	90cm	RGB	48	34W	12 pieces/carton
AL0646	Evo Slim Double LED RGB	120cm	RGB	72	50W	12 pieces/carton

Power Input : 100V - 260VAC / 50Hz-60Hz | Power Output : +24VDC

EVO SLIM LED

**NEW
ARRIVAL**



WHITE

FEATURES

- **Easy to Install** - Extendable Leg and Clamp (included) allow the light to be easily mounted.
- **Energy Saving** - Low electrical consumption, greater energy savings!
- **Beautiful Colours** - Daylight White that is close to natural daylight.
- **Cool** - Low heat emission compared to other light forms.



SPECIFICATIONS

Code No.	Description	Length	LED	LED (pcs)	Total Power	Packing
AL0647	Evo Slim LED White	30cm	White	12	10W	24 pieces/carton
AL0648	Evo Slim LED White	36cm	White	15	12W	24 pieces/carton
AL0649	Evo Slim LED White	45cm	White	21	17W	24 pieces/carton
AL0650	Evo Slim LED White	60cm	White	24	20W	24 pieces/carton

Power Input : 100V - 260VAC / 50Hz-60Hz | Power Output : +12VDC

DOUBLE LED

**NEW
ARRIVAL**



WHITE

Double the brightness, double the coverage!

FEATURES

- **Easy to Install** - Extendable Leg and Clamp (included) allow the light to be easily mounted.
- **Energy Saving** - Low electrical consumption, greater energy savings!
- **Beautiful Colours** - Daylight White that is close to natural daylight.
- **Cool** - Low heat emission compared to other light forms.



SPECIFICATIONS

Code No.	Description	Length	LED	LED (pcs)	Total Power	Packing
AL0651	Evo Slim Double LED White	60cm	White	36	25W	12 pieces/carton
AL0652	Evo Slim Double LED White	90cm	White	48	39W	12 pieces/carton
AL0653	Evo Slim Double LED White	120cm	White	72	54W	12 pieces/carton
AL0654	Evo Slim Double LED White	150cm	White	90	65W	12 pieces/carton

Power Input : 100V - 260VAC / 50Hz-60Hz | Power Output : +24VDC

EVO SLIM LED

**NEW
ARRIVAL**



**NEON
TROPICAL**

FEATURES

- **EASY TO INSTALL** - Extendable Leg and Clamp (included) allow the light to be easily mounted.
- **COOL LIGHTING** - Low heat emission compared to other conventional light bulbs forms.
- **ENERGY SAVING** - Low electrical consumption, greater energy savings!
- **Marine Blue Effect** - Corals photosynthesize best under lighting conditions dominated in mixtures of Actinic Blue and Violet light which also helps to achieve color-popping fluorescence.
- **Deep Neon Effect** - The special lighting mix of Actinic Blue and Violet wavelength creates a Deep Neon color rendering effect that can visually enhance neon and luminous fish species making their body scale colors pop.

SPECIFICATIONS

Code No.	Description	Length	LED	LED (pcs)	Total Power	Packing
AL0631	Evo Slim LED Neon Tropical	30cm	Actinic Blue + Violet + RGB	12	10W	24 pieces/carton
AL0632	Evo Slim LED Neon Tropical	36cm	Actinic Blue + Violet + RGB	15	12W	24 pieces/carton
AL0633	Evo Slim LED Neon Tropical	45cm	Actinic Blue + Violet + RGB	21	17W	24 pieces/carton
AL0634	Evo Slim LED Neon Tropical	60cm	Actinic Blue + Violet + RGB	24	20W	24 pieces/carton

Power Input : 100V - 260VAC / 50Hz-60Hz | Power Output : +12VDC

DOUBLE LED

**NEW
ARRIVAL**



**NEON
TROPICAL**

Double the brightness, double the coverage!

FEATURES

- **EASY TO INSTALL** - Extendable Leg and Clamp (included) allow the light to be easily mounted.
- **COOL LIGHTING** - Low heat emission compared to other conventional light bulbs forms.
- **ENERGY SAVING** - Low electrical consumption, greater energy savings!
- **Marine Blue Effect** - Corals photosynthesize best under lighting conditions dominated in mixtures of Actinic Blue and Violet light which also helps to achieve color-popping fluorescence.
- **Deep Neon Effect** - The special lighting mix of Actinic Blue and Violet wavelength creates a Deep Neon color rendering effect that can visually enhance neon and luminous fish species making their body scale colors pop.

SPECIFICATIONS

Code No.	Description	Length	LED	LED (pcs)	Total Power	Packing
AL0635	Evo Slim Double LED Neon Tropical	60cm	Actinic Blue + Violet + RGB	36	25W	12 pieces/carton
AL0636	Evo Slim Double LED Neon Tropical	90cm	Actinic Blue + Violet + RGB	48	34W	12 pieces/carton
AL0637	Evo Slim Double LED Neon Tropical	120cm	Actinic Blue + Violet + RGB	72	50W	12 pieces/carton

Power Input : 100V - 260VAC / 50Hz-60Hz | Power Output : +24VDC

EVO SLIM LED

**NEW
ARRIVAL**



FEATURES

- **Easy to Install** - Extendable Leg and Clamp (included) allow the light to be easily mounted.
- **Energy Saving** - Low electrical consumption, greater energy savings!
- **Beautiful Colours** - Blue + White can enhance the coloration of fish and marine coral.
- **Cool** - Low heat emission compared to other light forms.

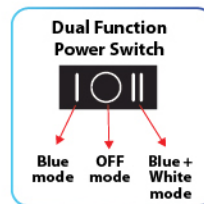

SPECIFICATIONS

Code No.	Description	Length	LED	LED (pcs)	Total Power	Packing
AL0655	Evo Slim LED Blue + White	30cm	Blue + White	12	10W	24 pieces/carton
AL0656	Evo Slim LED Blue + White	36cm	Blue + White	15	12W	24 pieces/carton
AL0657	Evo Slim LED Blue + White	45cm	Blue + White	21	17W	24 pieces/carton
AL0658	Evo Slim LED Blue + White	60cm	Blue + White	24	20W	24 pieces/carton

Power Input : 100V - 260VAC / 50Hz-60Hz | Power Output : +12VDC

DOUBLE LED

**NEW
ARRIVAL**



Double the brightness, double the coverage!

FEATURES

- **Easy to Install** - Extendable Leg and Clamp (included) allow the light to be easily mounted.
- **Energy Saving** - Low electrical consumption, greater energy savings!
- **Beautiful Colours** - Blue + White can enhance the coloration of fish and marine coral.
- **Cool** - Low heat emission compared to other light forms.

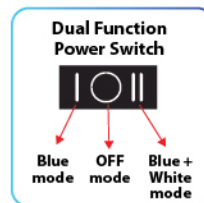

SPECIFICATIONS

Code No.	Description	Length	LED	LED (pcs)	Total Power	Packing
AL0659	Evo Slim Double LED Blue + White	60cm	Blue + White	36	25W	12 pieces/carton
AL0660	Evo Slim Double LED Blue + White	90cm	Blue + White	48	39W	12 pieces/carton
AL0661	Evo Slim Double LED Blue + White	120cm	Blue + White	72	54W	12 pieces/carton

Power Input : 100V - 260VAC / 50Hz-60Hz | Power Output : +24VDC

SUPER SLIM LED

NEW
ARRIVAL

CLAMPING LAMP

RGB



AL0621



AL0620

FEATURES

- **SLIM** - The small sized RGB Light-Emitting Diode (LED) allows for sleeker, slimmer casing design. Ideal for use with Nano tanks.
- **COOL LIGHTING** - Low heat emission compared to other conventional light bulbs forms.
- **ENERGY SAVING** - Low electrical consumption, greater energy savings !
- **Wide Color Spectrum** – With RGB LED, they can emit a wider color spectrum to better replicate natural Sunlight for fishes and aquatic plants growth.
- **High CRI** – With RGB LED, they can achieve a higher CRI Color Rendering Index to render the true colors and vibrant tones of objects making your fishes and plants appear more colorful and vivid.

SPECIFICATION

Code No.	LED	LED PCS	Total Watt	Packing
AL0620	RGB	12	9W	12pcs / ctn
AL0621	RGB	18	14W	12pcs / ctn



SUPER SLIM LED

NEW
ARRIVAL

CLAMPING LAMP

ACTINIC BLUE + VIOLET



AL0630

AL0629



FEATURES

- **SLIM** - The small sized Actinic Blue + Violet Light-Emitting Diode (LED) allows for sleeker, slimmer casing design. Ideal for use with Nano tanks.
- **COOL LIGHTING** - Low heat emission compared to other conventional light bulbs forms.
- **ENERGY SAVING** - Low electrical consumption, greater energy savings!
- **Deep Neon Effect** - The special lighting mix of Actinic Blue and Violet wavelength creates a Deep Neon color rendering effect that can visually enhance neon and luminous fish species making their body scale colors pop.
- **Marine Blue Effect** - Corals photosynthesize best under lighting conditions dominated in mixtures of Actinic Blue and Violet light which also helps to achieve color-popping florescence.

SPECIFICATION

Code No.	LED	LED PCS	Total Watt	Packing
AL0629	Actinic Blue + Violet	12	10W	12pcs / ctn
AL0630	Actinic Blue + Violet	18	15W	12pcs / ctn

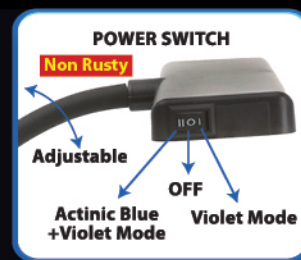

COMPARISON



SUPER SLIM LED

NEW
ARRIVAL

CLAMPING LAMP

G3

WHITE + BLUE



AL0639

AL0638

FEATURES

- **SLIM** - The small sized White + Blue Light-Emitting Diode (LED) allows for sleeker, slimmer casing design. Ideal for use with Nano tanks.
- **COOL LIGHTING** - Low heat emission compared to other conventional light bulbs forms.
- **ENERGY SAVING** - Low electrical consumption, greater energy savings !
- **DUAL LIGHT-MODE** - Recreates the daytime and moonlight conditions of nature.
- **NON-TOXIC** - Do not contain harmful chemicals unlike conventional lighting.

SPECIFICATION

Code No.	LED	LED PCS	Total Watt	Packing
AL0638	White + Blue	12	10W	12pcs / ctn
AL0639	White + Blue	18	15W	12pcs / ctn

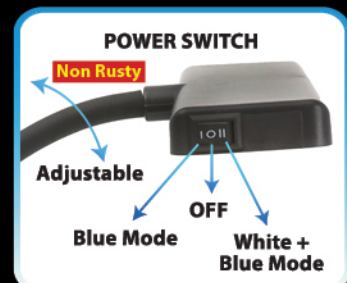

RESINS ORNAMENTS

- Colorful high quality resins for aquarium and other pet use
- Non toxic and detailed workmanship
- Comes in various design and patterns
- Customization possible upon request



ON0460



ON0461



ON0462



ON0463



ON0464



Y139



BKM



Y19



Y18



Y140



BKL



Y20



Y141

Code No.	Description	Specification	Packing
ON0460	QY-09 Ornament (19 x 8 x 19cm)	Creative Resin	30 pieces/carton
ON0461	QY-10 Ornament (18.5 x 10 x 19.5cm)	Creative Resin	30 pieces/carton
ON0462	QY-11 Ornament (17 x 9 x 20cm)	Creative Resin	30 pieces/carton
ON0463	QY-12 Ornament (17 x 8.5 x 19cm)	Creative Resin	30 pieces/carton
ON0464	QY-13 Ornament (19 x 8.5 x 17cm)	Creative Resin	30 pieces/carton
BKL	Drum (L)	Superior Resin	36 pieces/carton
BKM	Drum (M)	Superior Resin	48 pieces/carton
Y18	Small Jar	Superior Resin	120 pieces/carton
Y19	Medium Jar	Superior Resin	60 pieces/carton
Y20	Big Jar	Superior Resin	12 pieces/carton
Y139	Wooden Bridge (9 x 6.5 x 4cm)	Superior Resin	48 pieces/carton
Y140	Wooden Bridge (23.5 x 9.5 x 5cm)	Superior Resin	24 pieces/carton
Y141	Wooden Bridge (32.5 x 14 x 7cm)	Superior Resin	18 pieces/carton

NANO SLIMDISK AIRSTONE

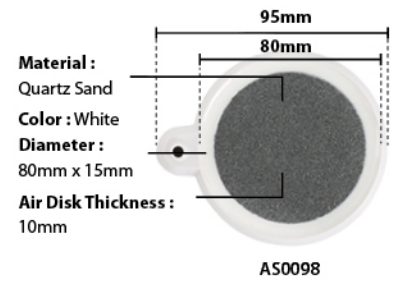
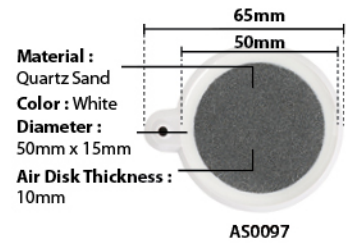

Introduction

Classica Premium Nano SlimDisk Airstone is designed for maximum aeration surface on a solid compact base. The quartz sand structure produces very fine and uniform bubbles, thus enabling unmatched oxygenating power, improves water circulation to every corner of the aquarium, prevent dead spots and reduces algae growth.

Features

- Slim Design with heavy and stable base
- Maximum fine bubbles emission surface
- Low pressure, high permeability air venting
- Hard resin-sealed monobloc design, no leak

Code No.	Description	Color	Packing
AS0097	Nano Slimdisk Airstone SD-50	White	200 pieces/carton
AS0098	Nano Slimdisk Airstone SD-80	White	75 pieces/carton

NANO TECH BUBBLE DIFFUSER

Features

- Helps create low turbulence, highly oxygenated aquarium environment.
- Creates aesthetically pleasing ultra-fine bubbles
- Helps increase DO (Dissolved Oxygen) level in Aquarium
- Nano Bubbles causes less water loss due to splashing compared to large bubbles
- Stays in water for prolonged periods of time

Includes

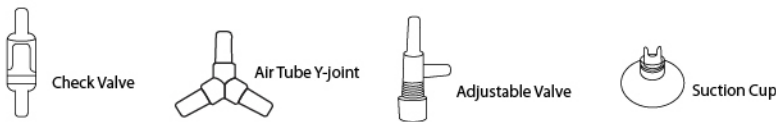

Suggested Installation

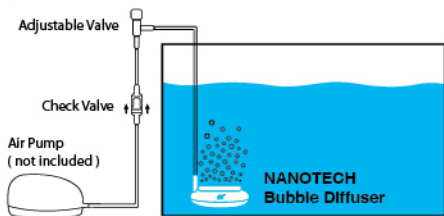

Does not require high pressure airpump. Usable with most conventional airpump.

Code No.	Description	Specification	Packing
AS090	Nano Tech Bubble Diffuser 50mm disc	ø50mm / ø70mm	100 pieces/carton
AS091	Nano Tech Bubble Diffuser 100mm disc	ø100mm / ø130mm	30 pieces/carton
AS092	Nano Tech Bubble Diffuser 150mm disc	ø150mm / ø180mm	20 pieces/carton

BLACK SAMURAI

PRO FILTER MEDIUM

3DM Octas



FM177G

FM177H

Performance Highlights

- Improved Surface Area 2980 m²/L
- 99% Bacteria Coverage Space
- Ideal Bacteria Conditions
- Light-Shielding Black Structure
- Improved Formula

- High-Strength Macro-Porous Build
- Clean, Stable Bio-Film Support
- Environmentally Friendly
- pH Neutral



L



XL



Enhanced Water Purification.

The upgraded porous structure breaks down ammonia, nitrite, and nitrate more efficiently, giving clearer water and a more stable nitrogen cycle even under heavier bio-load.

Faster & Denser Bacteria Growth.

The improved material composition offers up to 99% coverage space, giving beneficial bacteria more usable surfaces to anchor and grow. This allows colonies to establish themselves more quickly and maintain a denser, more stable presence across the media over time.

Larger Effective Surface Area.

Tested with BET surface area analysis, the media now provides 2980 m²/L of active surface area, outperforming typical ceramic rings and offering higher filtration power in all tank sizes.

pH Neutral.

The improved formula remains fully inert and does not alter pH, KH, or GH, making it suitable for soft-water, hard-water, brackish and marine setups.

Longer Water Contact Time.

Refined internal pathways increase water retention time within the media, allowing deeper biological processing and more complete waste breakdown.

Stronger, Cleaner & Longer-Lasting.

The Black Samurai blend improves durability, reduces dusting, and resists clogging, ensuring smoother flow and a longer operational life inside any filter.

Revolutionary Beneficial Bacteria Media

Technical Data

- Porosity : 40 – 75%
- Water Absorptivity : 30 – 78%
- Volume Density : 0.5g/cm³
- Surface Area/Volume : 2980m²/L (effective surface area)
- Spatial Aperture Range : Micro (0.10 – 10µm),
Medium (10 – 500µm),
Large (0.1 – 3mm)
- pH : 7 – 7.5
- Percolation Rate : 0.2 – 0.6cm / sec
- Conductivity : 40 – 145 (ppm)
- Cavity Structure : Continuous 2 – 3 dimensional cavity
- Density Range : >0.30 <0.60

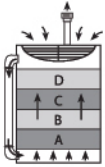

1. External Pond Filter



2. Canister Filter

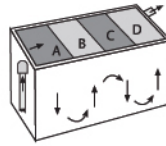

3. Box Filter

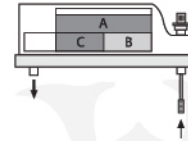

4. Top Filter

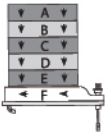

5. Multi-layer Trickle Overhead Filter

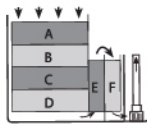

6. Sump Trickle Filter

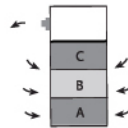

7. Internal Filter



8. Baker Tricking System

Magnified view of exploded continuous cavities and interlinked micro-tunnels.

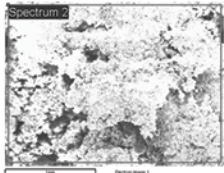

electronic image

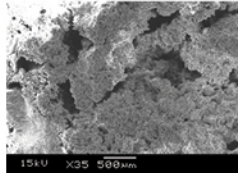

x35

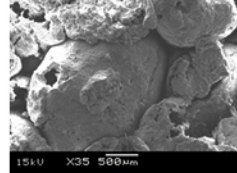

electronic image



0.1-3mm large cavity

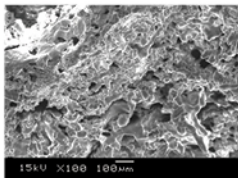

x100

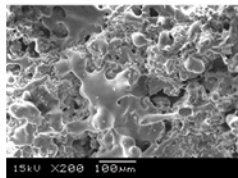

x200

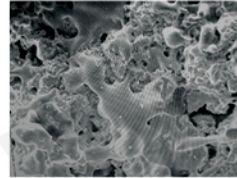

10-500µm medium cavity

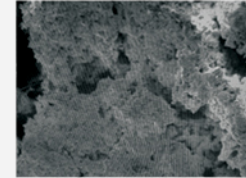

0.1-10µm micro cavity

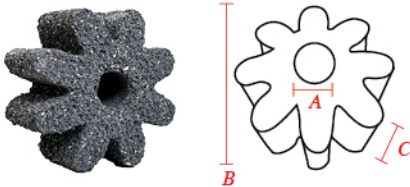

- A:** ø23-25mm (L); ø27-30mm (XL)
- B:** ø97-100mm (L); ø138-142mm (XL)
- C:** 80-84mm (L); 80-84mm (XL)

Code No	Description	Specification	Packing
FM177D	3DM Black Samurai Octas	L	48 pieces/carton
FM177E	3DM Black Samurai Octas	XL	27 pieces/carton
FM177G	3DM Black Samurai Octas	L	6 pieces/box
FM177H	3DM Black Samurai Octas	XL	6 pieces/box

SUPREME QUALITY FILTER WOOL

- Superior multiple wool types and bio-foam for all filtration usage
- High quality, durable and re-usable
- Widest selection in the market
- For freshwater and saltwater use
- Can be used for most major filter types



Code No.	Description	Specification	Packing
AW0135	Supreme Quality Filter Wool	29cm (L) x 16cm (W)	4 pieces/bag

SUPERIOR FILTRATION WOOL

- Different grades of loose wool for filtration purposes
- Washable and ideal for mini air powered filters



AW006A



AW006

Code No.	Description	Specification	Packing
AW006A	Uncut Wool	36.58m (L) x 1.5m (W)	36.58m/roll
AW006	Rectangular Wool	110cm (L) x 45cm (W)	20 pieces/bag

BLUE / GREEN / WHITE COARSE WOOL

- High quality coarse filter wool for mechanical and biological filtration
- Durable and re-usable
- Customization of sizes possible upon request

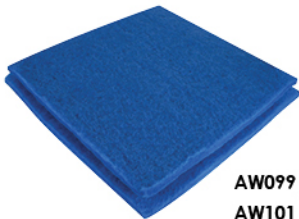
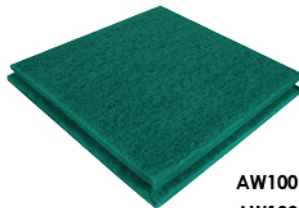
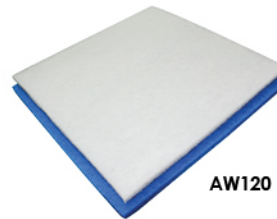
AW099 /
AW101AW100 /
AW102

AW120

Code No.	Description	Specification	Packing
AW099	Blue Coarse Wool	200 x 100 x 2cm	5 pieces/bag
AW100	Green Coarse Wool	200 x 100 x 2cm	5 pieces/bag
AW101	Blue Coarse Wool	50 x 50 x 2cm	20 pieces/bag
AW102	Green Coarse Wool	50 x 50 x 2cm	20 pieces/bag
AW120	White / Blue Coarse Wool	50 x 50 x 2cm	20 pieces/bag