

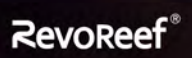

Catalogue

2024 | 2025

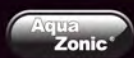

ABOUT QIAN HU CORPORATION

Incorporated in **1998** and listed on the Singapore Exchange since 2000, Qian Hu Corporation Limited is an integrated ornamental fish service provider with business activities ranging from the breeding of Dragon Fish to farming, importing, exporting and distributing of over 1,000 species and varieties of ornamental fish from all over the world. Yi Hu Fish Farm Trading (a subsidiary of Qian Hu Corporation Limited) manufactures and distributes a wide range of aquarium and pet accessories. Qian Hu currently exports ornamental fish to over 80 countries, securing Singapore's reputation as The Ornamental Fish Capital of the World.



Over the years, the Group has developed its proprietary brands of aquarium accessories under the name RevoReef®, OF®, Ocean Free®, Aqua Zonic®, Classica®, PONDdpro® and ReptilePro®, and pet accessories under the name Aristocats®, Sumo Cats®, Delicate® and Bark®. The export of aquarium and pet accessories has seen a healthy momentum of growth to approximately 40 countries around the world.

In this era of rapid technological advancement, the group has been able to quickly anticipate and respond to global market changes. Through our dedicated team of researchers, marketers and designers, there have been excellent examples of innovation products in the past years with more flourishing in the pipeline that have potential for creating value for the entire industry.

Hydra Depurator **Freshwater**



Powered by:



Hydra Stream **Freshwater**



Hydra Depurator



Hydra Filtron



Hydra Nano Plus



Hydra Stream



Bio-Mech Chamber

BB-Mech Chamber

BB-Mech Chamber Stirrer



Hydra Ginox

UV Radiator



CONTENT

MAIN

01	Fish Food	004 - 055
02	Fish Tank	056 - 078
03	Filter / Skimmer	079 - 110
04	UV Filter	111 - 116
05	Pump	117 - 128

06	Air Pump	129 - 135
07	Lightset / Fixture	136 - 163
08	Light Tube	164 - 169
09	Heater / Cooler	170 - 173
10	Planted Tank Accessories	174 - 181

MEDICATION

11	Medication	182 - 205
12	Aquarium Salt	206 - 207

DISPLAY

13	Plastic Plant	208
14	Ornament	209 - 211
15	Decorative Wood	212
16	Gravel & Sand	213 - 214

OTHER ACCESSORIES

17	Air Stone, Air Tube & Related	215 - 220
18	Filter Medium	221 - 234
19	Filter Wool	235 - 237
20	Fish Net	238
21	Tank Maintenance	239
22	Measurement	240
23	Others	241 - 243

SPECIAL PRODUCTS

24	Pondpro	244 - 249
25	Reptilepro	250 - 258
26	Revoreef	259 - 266



Pro

KIRAMEKI

COMPETITION GRADE



Pro Xtreme Colour

Pro Colour

Pro Balance

Pro Hi-Growth

Pro Multi-Season

10kg, 15kg & 20kg



1kg



5kg



Protein Linker
OF Optima



Immunity
Booster



Low Oil
Formula



No Hormones



Will Not
Cloud Water



Probiotics



Colour Enhance



Enhance
Koi Sumi



High Mineral
Contained



Easy to Digest



Growth



Staple Food

Overall Feed Performance
Percentage (%)

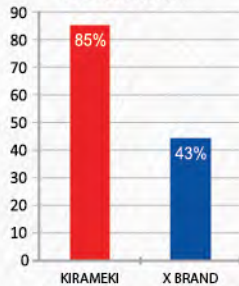

Protein Digestibility / Absorption
Percentage (%)

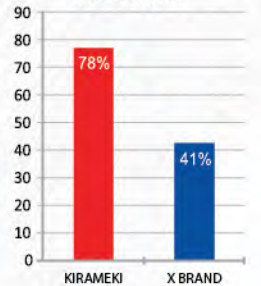

* Graph above is derived from the formula below digestibility of nutrient in test feed (%)

$$= \frac{(A) - (B \times C) \times 100}{D}$$

A = Digestibility of nutrient in Test Feed
 B = Digestibility of nutrient in a basal feed
 C = Proportion of total nutrient in diet supplied by basal feed
 D = Proportion of total nutrient in diet supplied by Test Feed

GUARANTEED ANALYSIS



Pro Balance

Crude Protein : 47% (min)
 Crude Fat : 5.5% (min)
 Crude Fiber : 1.2% (max)
 Ash : 15% (max)
 Moisture : 9% (max)
 Calcium : 3.2% (min)
 Phosphorus : 2% (min)



Pro Hi-Growth

Crude Protein : 49% (min)
 Crude Fat : 5.5% (min)
 Crude Fiber : 1% (max)
 Ash : 14% (max)
 Moisture : 9% (max)
 Calcium : 3.2% (min)
 Phosphorus : 2% (min)



Pro Colour

Crude Protein : 48% (min)
 Crude Fat : 5% (min)
 Crude Fiber : 1% (max)
 Ash : 14% (max)
 Moisture : 9% (max)
 Calcium : 2.5% (min)
 Phosphorus : 1.7% (min)



Pro Multi-Season

Crude Protein : 48% (min)
 Crude Fat : 5% (min)
 Crude Fiber : 1% (max)
 Ash : 14% (max)
 Moisture : 9% (max)
 Calcium : 3% (min)
 Phosphorus : 1.9% (min)



Pro Xtreme Colour

Crude Protein : 48% (min)
 Crude Fat : 5% (min)
 Crude Fiber : 1% (max)
 Ash : 13% (max)
 Moisture : 9% (max)
 Calcium : 3% (min)
 Phosphorus : 1.9% (min)



Small Pellet Size: ø2.7 - 3mm



Medium Pellet Size: ø5 - 6mm



Large Pellet Size: ø7 - 8.5mm

*Inner bags : 5kg = 1kg x 5 | 10kg = 2kg x 5 | 15kg = 3kg x 5 | 20kg = 4kg x 5

Code No.	Description	Specification	Packing
FF1315	Pro Balance (floating)	Small Pellet - 1kg	12 packets/carton
FF1316	Pro Balance (floating)	Medium Pellet - 1kg	12 packets/carton
FF1317	Pro Balance (floating)	Large Pellet - 1kg	12 packets/carton
FF1318	Pro Balance (sinking)	Small Pellet - 1kg	12 packets/carton
FF1319	Pro Balance (sinking)	Medium Pellet - 1kg	12 packets/carton
FF1320	Pro Balance (sinking)	Large Pellet - 1kg	12 packets/carton
FF1184	Pro Balance (floating)	Small Pellet - 5kg	4 packets/carton
FF1185	Pro Balance (floating)	Medium Pellet - 5kg	4 packets/carton
FF1186	Pro Balance (floating)	Large Pellet - 5kg	4 packets/carton
FF1187	Pro Balance (floating)	Small Pellet - 10kg	Individual
FF1188	Pro Balance (floating)	Medium Pellet - 10kg	Individual
FF1189	Pro Balance (floating)	Large Pellet - 10kg	Individual
FF1190	Pro Balance (floating)	Small Pellet - 15kg	Individual
FF1191	Pro Balance (floating)	Medium Pellet - 15kg	Individual
FF1192	Pro Balance (floating)	Large Pellet - 15kg	Individual
FF1193	Pro Balance (sinking)	Small Pellet - 20kg	Individual
FF1194	Pro Balance (sinking)	Medium Pellet - 20kg	Individual
FF1195	Pro Balance (sinking)	Large Pellet - 20kg	Individual

Code No.	Description	Specification	Packing
FF1321	Pro Hi-Growth (floating)	Small Pellet - 1kg	12 packets/carton
FF1322	Pro Hi-Growth (floating)	Medium Pellet - 1kg	12 packets/carton
FF1323	Pro Hi-Growth (floating)	Large Pellet - 1kg	12 packets/carton
FF1324	Pro Hi-Growth (sinking)	Small Pellet - 1kg	12 packets/carton
FF1325	Pro Hi-Growth (sinking)	Medium Pellet - 1kg	12 packets/carton
FF1326	Pro Hi-Growth (sinking)	Large Pellet - 1kg	12 packets/carton
FF1196	Pro Hi-Growth (floating)	Small Pellet - 5kg	4 packets/carton
FF1197	Pro Hi-Growth (floating)	Medium Pellet - 5kg	4 packets/carton
FF1198	Pro Hi-Growth (floating)	Large Pellet - 5kg	4 packets/carton
FF1199	Pro Hi-Growth (floating)	Small Pellet - 10kg	Individual
FF1200	Pro Hi-Growth (floating)	Medium Pellet - 10kg	Individual
FF1201	Pro Hi-Growth (floating)	Large Pellet - 10kg	Individual
FF1202	Pro Hi-Growth (floating)	Small Pellet - 15kg	Individual
FF1203	Pro Hi-Growth (floating)	Medium Pellet - 15kg	Individual
FF1204	Pro Hi-Growth (floating)	Large Pellet - 15kg	Individual
FF1205	Pro Hi-Growth (sinking)	Small Pellet - 20kg	Individual
FF1206	Pro Hi-Growth (sinking)	Medium Pellet - 20kg	Individual
FF1207	Pro Hi-Growth (sinking)	Large Pellet - 20kg	Individual
FF1327	Pro Colour (floating)	Small Pellet - 1kg	12 packets/carton
FF1328	Pro Colour (floating)	Medium Pellet - 1kg	12 packets/carton
FF1329	Pro Colour (floating)	Large Pellet - 1kg	12 packets/carton
FF1330	Pro Colour (sinking)	Small Pellet - 1kg	12 packets/carton
FF1331	Pro Colour (sinking)	Medium Pellet - 1kg	12 packets/carton
FF1332	Pro Colour (sinking)	Large Pellet - 1kg	12 packets/carton
FF1208	Pro Colour (floating)	Small Pellet - 5kg	4 packets/carton
FF1209	Pro Colour (floating)	Medium Pellet - 5kg	4 packets/carton
FF1210	Pro Colour (floating)	Large Pellet - 5kg	4 packets/carton
FF1211	Pro Colour (floating)	Small Pellet - 10kg	Individual
FF1212	Pro Colour (floating)	Medium Pellet - 10kg	Individual
FF1213	Pro Colour (floating)	Large Pellet - 10kg	Individual
FF1214	Pro Colour (floating)	Small Pellet - 15kg	Individual
FF1215	Pro Colour (floating)	Medium Pellet - 15kg	Individual
FF1216	Pro Colour (floating)	Large Pellet - 15kg	Individual
FF1217	Pro Colour (sinking)	Small Pellet - 20kg	Individual
FF1218	Pro Colour (sinking)	Medium Pellet - 20kg	Individual
FF1219	Pro Colour (sinking)	Large Pellet - 20kg	Individual
FF1333	Pro Multi-Season (floating)	Small Pellet - 1kg	12 packets/carton
FF1334	Pro Multi-Season (floating)	Medium Pellet - 1kg	12 packets/carton
FF1335	Pro Multi-Season (floating)	Large Pellet - 1kg	12 packets/carton
FF1336	Pro Multi-Season (sinking)	Small Pellet - 1kg	12 packets/carton
FF1337	Pro Multi-Season (sinking)	Medium Pellet - 1kg	12 packets/carton
FF1338	Pro Multi-Season (sinking)	Large Pellet - 1kg	12 packets/carton
FF1220	Pro Multi-Season (floating)	Small Pellet - 5kg	4 packets/carton
FF1221	Pro Multi-Season (floating)	Medium Pellet - 5kg	4 packets/carton
FF1222	Pro Multi-Season (floating)	Large Pellet - 5kg	4 packets/carton
FF1223	Pro Multi-Season (floating)	Small Pellet - 10kg	Individual
FF1224	Pro Multi-Season (floating)	Medium Pellet - 10kg	Individual
FF1225	Pro Multi-Season (floating)	Large Pellet - 10kg	Individual
FF1226	Pro Multi-Season (floating)	Small Pellet - 15kg	Individual
FF1227	Pro Multi-Season (floating)	Medium Pellet - 15kg	Individual
FF1228	Pro Multi-Season (floating)	Large Pellet - 15kg	Individual
FF1229	Pro Multi-Season (sinking)	Small Pellet - 20kg	Individual
FF1230	Pro Multi-Season (sinking)	Medium Pellet - 20kg	Individual
FF1231	Pro Multi-Season (sinking)	Large Pellet - 20kg	Individual
FF1339	Pro Xtreme Colour (floating)	Small Pellet - 1kg	12 packets/carton
FF1340	Pro Xtreme Colour (floating)	Medium Pellet - 1kg	12 packets/carton
FF1341	Pro Xtreme Colour (floating)	Large Pellet - 1kg	12 packets/carton
FF1342	Pro Xtreme Colour (sinking)	Small Pellet - 1kg	12 packets/carton
FF1343	Pro Xtreme Colour (sinking)	Medium Pellet - 1kg	12 packets/carton
FF1344	Pro Xtreme Colour (sinking)	Large Pellet - 1kg	12 packets/carton
FF1232	Pro Xtreme Colour (floating)	Small Pellet - 5kg	4 packets/carton
FF1233	Pro Xtreme Colour (floating)	Medium Pellet - 5kg	4 packets/carton
FF1234	Pro Xtreme Colour (floating)	Large Pellet - 5kg	4 packets/carton
FF1235	Pro Xtreme Colour (floating)	Small Pellet - 10kg	Individual
FF1236	Pro Xtreme Colour (floating)	Medium Pellet - 10kg	Individual
FF1237	Pro Xtreme Colour (floating)	Large Pellet - 10kg	Individual
FF1238	Pro Xtreme Colour (floating)	Small Pellet - 15kg	Individual
FF1239	Pro Xtreme Colour (floating)	Medium Pellet - 15kg	Individual
FF1240	Pro Xtreme Colour (floating)	Large Pellet - 15kg	Individual
FF1241	Pro Xtreme Colour (sinking)	Small Pellet - 20kg	Individual
FF1242	Pro Xtreme Colour (sinking)	Medium Pellet - 20kg	Individual
FF1243	Pro Xtreme Colour (sinking)	Large Pellet - 20kg	Individual

KIRAMEKI

Super Premium



Xtreme Colour

Colour

Balance

Hi-Growth

Multi-Season

10kg, 15kg & 20kg



1kg



5kg



Protein Linker
OF Optima



Immunity
Booster



Low Oil
Formula



No Hormones



Will Not
Cloud Water



Probiotics



Colour Enhance



Enhance
Koi Sumi



High Mineral
Contained



Easy to Digest



Growth



Staple Food

Overall Feed Performance
Percentage (%)

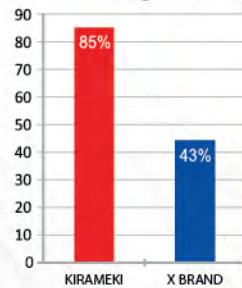

Protein Digestibility / Absorption
Percentage (%)

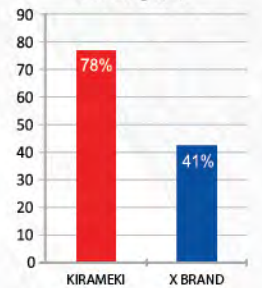

* Graph above is derived from the formula below digestibility of nutrient in test feed (%)

$$= \frac{(A) - (B \times C)}{D} \times 100$$

A = Digestibility of nutrient in Test Feed
 B = Digestibility of nutrient in a basal feed
 C = Proportion of total nutrient in diet supplied by basal feed
 D = Proportion of total nutrient in diet supplied by Test Feed

GUARANTEED ANALYSIS



Balance

Crude Protein : 43% (min)
 Crude Fat : 5% (min)
 Crude Fiber : 1.7% (max)
 Ash : 16% (max)
 Moisture : 9% (max)
 Calcium : 3% (min)
 Phosphorus : 1.8% (min)



Hi-Growth

Crude Protein : 49% (min)
 Crude Fat : 5.5% (min)
 Crude Fiber : 1.1% (max)
 Ash : 15% (max)
 Moisture : 9% (max)
 Calcium : 3.2% (min)
 Phosphorus : 2% (min)



Colour

Crude Protein : 46% (min)
 Crude Fat : 5% (min)
 Crude Fiber : 1.3% (max)
 Ash : 15% (max)
 Moisture : 9% (max)
 Calcium : 3% (min)
 Phosphorus : 1.8% (min)



Multi-Season

Crude Protein : 47% (min)
 Crude Fat : 5% (min)
 Crude Fiber : 1% (max)
 Ash : 15% (max)
 Moisture : 9% (max)
 Calcium : 3% (min)
 Phosphorus : 1.9% (min)



Xtreme Colour

Crude Protein : 47% (min)
 Crude Fat : 5% (min)
 Crude Fiber : 1% (max)
 Ash : 14% (max)
 Moisture : 9% (max)
 Calcium : 3% (min)
 Phosphorus : 1.9% (min)

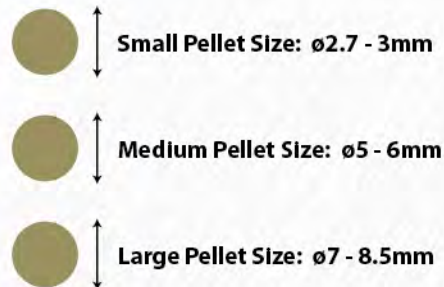

*Inner bags : 5kg = 1kg x 5 | 10kg = 2kg x 5 | 15kg = 3kg x 5 | 20kg = 4kg x 5

Code No.	Description	Specification	Packing
FF1345	Balance (floating)	Small Pellet - 1kg	12 packets/carton
FF1346	Balance (floating)	Medium Pellet - 1kg	12 packets/carton
FF1347	Balance (floating)	Large Pellet - 1kg	12 packets/carton
FF1348	Balance (sinking)	Small Pellet - 1kg	12 packets/carton
FF1349	Balance (sinking)	Medium Pellet - 1kg	12 packets/carton
FF1350	Balance (sinking)	Large Pellet - 1kg	12 packets/carton
FF1060	Balance (floating)	Small Pellet - 5kg	4 packets/carton
FF1061	Balance (floating)	Medium Pellet - 5kg	4 packets/carton
FF1062	Balance (floating)	Large Pellet - 5kg	4 packets/carton
FF1261	Balance (floating)	Small Pellet - 10kg	Individual
FF932	Balance (floating)	Medium Pellet - 10kg	Individual
FF933	Balance (floating)	Large Pellet - 10kg	Individual
FF1262	Balance (floating)	Small Pellet - 15kg	Individual
FF1263	Balance (floating)	Medium Pellet - 15kg	Individual
FF1264	Balance (floating)	Large Pellet - 15kg	Individual
FF1265	Balance (sinking)	Small Pellet - 20kg	Individual
FF1266	Balance (sinking)	Medium Pellet - 20kg	Individual
FF1267	Balance (sinking)	Large Pellet - 20kg	Individual

Code No.	Description	Specification	Packing
FF1351	Hi-Growth (floating)	Small Pellet - 1kg	12 packets/carton
FF1352	Hi-Growth (floating)	Medium Pellet - 1kg	12 packets/carton
FF1353	Hi-Growth (floating)	Large Pellet - 1kg	12 packets/carton
FF1354	Hi-Growth (sinking)	Small Pellet - 1kg	12 packets/carton
FF1355	Hi-Growth (sinking)	Medium Pellet - 1kg	12 packets/carton
FF1356	Hi-Growth (sinking)	Large Pellet - 1kg	12 packets/carton
FF1101	Hi-Growth (floating)	Small Pellet - 5kg	4 packets/carton
FF1102	Hi-Growth (floating)	Medium Pellet - 5kg	4 packets/carton
FF1258	Hi-Growth (floating)	Large Pellet - 5kg	4 packets/carton
FF1249	Hi-Growth (floating)	Small Pellet - 10kg	Individual
FF1250	Hi-Growth (floating)	Medium Pellet - 10kg	Individual
FF1251	Hi-Growth (floating)	Large Pellet - 10kg	Individual
FF1252	Hi-Growth (floating)	Small Pellet - 15kg	Individual
FF1253	Hi-Growth (floating)	Medium Pellet - 15kg	Individual
FF1254	Hi-Growth (floating)	Large Pellet - 15kg	Individual
FF1255	Hi-Growth (sinking)	Small Pellet - 20kg	Individual
FF1256	Hi-Growth (sinking)	Medium Pellet - 20kg	Individual
FF1257	Hi-Growth (sinking)	Large Pellet - 20kg	Individual
FF1357	Colour (floating)	Small Pellet - 1kg	12 packets/carton
FF1358	Colour (floating)	Medium Pellet - 1kg	12 packets/carton
FF1359	Colour (floating)	Large Pellet - 1kg	12 packets/carton
FF1360	Colour (sinking)	Small Pellet - 1kg	12 packets/carton
FF1361	Colour (sinking)	Medium Pellet - 1kg	12 packets/carton
FF1362	Colour (sinking)	Large Pellet - 1kg	12 packets/carton
FF1301	Colour (floating)	Small Pellet - 5kg	4 packets/carton
FF1302	Colour (floating)	Medium Pellet - 5kg	4 packets/carton
FF1303	Colour (floating)	Large Pellet - 5kg	4 packets/carton
FF1281	Colour (floating)	Small Pellet - 10kg	Individual
FF944	Colour (floating)	Medium Pellet - 10kg	Individual
FF945	Colour (floating)	Large Pellet - 10kg	Individual
FF1282	Colour (floating)	Small Pellet - 15kg	Individual
FF1283	Colour (floating)	Medium Pellet - 15kg	Individual
FF1284	Colour (floating)	Large Pellet - 15kg	Individual
FF1285	Colour (sinking)	Small Pellet - 20kg	Individual
FF1286	Colour (sinking)	Medium Pellet - 20kg	Individual
FF1287	Colour (sinking)	Large Pellet - 20kg	Individual
FF1363	Xtreme Colour (floating)	Small Pellet - 1kg	12 packets/carton
FF1364	Xtreme Colour (floating)	Medium Pellet - 1kg	12 packets/carton
FF1365	Xtreme Colour (floating)	Large Pellet - 1kg	12 packets/carton
FF1366	Xtreme Colour (sinking)	Small Pellet - 1kg	12 packets/carton
FF1367	Xtreme Colour (sinking)	Medium Pellet - 1kg	12 packets/carton
FF1368	Xtreme Colour (sinking)	Large Pellet - 1kg	12 packets/carton
FF1099	Xtreme Colour (floating)	Small Pellet - 5kg	4 packets/carton
FF1100	Xtreme Colour (floating)	Medium Pellet - 5kg	4 packets/carton
FF1288	Xtreme Colour (floating)	Large Pellet - 5kg	4 packets/carton
FF1291	Xtreme Colour (floating)	Small Pellet - 10kg	Individual
FF950	Xtreme Colour (floating)	Medium Pellet - 10kg	Individual
FF951	Xtreme Colour (floating)	Large Pellet - 10kg	Individual
FF1292	Xtreme Colour (floating)	Small Pellet - 15kg	Individual
FF1293	Xtreme Colour (floating)	Medium Pellet - 15kg	Individual
FF1294	Xtreme Colour (floating)	Large Pellet - 15kg	Individual
FF1295	Xtreme Colour (sinking)	Small Pellet - 20kg	Individual
FF1296	Xtreme Colour (sinking)	Medium Pellet - 20kg	Individual
FF1297	Xtreme Colour (sinking)	Large Pellet - 20kg	Individual
FF1369	Multi-Season (floating)	Small Pellet - 1kg	12 packets/carton
FF1370	Multi-Season (floating)	Medium Pellet - 1kg	12 packets/carton
FF1371	Multi-Season (floating)	Large Pellet - 1kg	12 packets/carton
FF1372	Multi-Season (sinking)	Small Pellet - 1kg	12 packets/carton
FF1373	Multi-Season (sinking)	Medium Pellet - 1kg	12 packets/carton
FF1374	Multi-Season (sinking)	Large Pellet - 1kg	12 packets/carton
FF1298	Multi-Season (floating)	Small Pellet - 5kg	4 packets/carton
FF1299	Multi-Season (floating)	Medium Pellet - 5kg	4 packets/carton
FF1300	Multi-Season (floating)	Large Pellet - 5kg	4 packets/carton
FF1271	Multi-Season (floating)	Small Pellet - 10kg	Individual
FF938	Multi-Season (floating)	Medium Pellet - 10kg	Individual
FF939	Multi-Season (floating)	Large Pellet - 10kg	Individual
FF1272	Multi-Season (floating)	Small Pellet - 15kg	Individual
FF1273	Multi-Season (floating)	Medium Pellet - 15kg	Individual
FF1274	Multi-Season (floating)	Large Pellet - 15kg	Individual
FF1275	Multi-Season (sinking)	Small Pellet - 20kg	Individual
FF1276	Multi-Season (sinking)	Medium Pellet - 20kg	Individual
FF1277	Multi-Season (sinking)	Large Pellet - 20kg	Individual



Different Functioning Stages of OF® Probiotics

OF® "Kirameki" koi feed Super Premium & Pro Competition Grade uses only high-quality raw materials, based on natural ingredients, without any hormones or chemical hormones. The feed contains OF®'s unique protein linker OF® Optima, which improves the digestibility and absorption rate of fish by more than 30%. In addition, OF® special probiotics are added to the feed to further improve the digestibility of the fish and help to organize the fish's intestines. It can also help break down the fish's excrement and gives the koi fish a cleaner and safer water quality. One product with many functions.

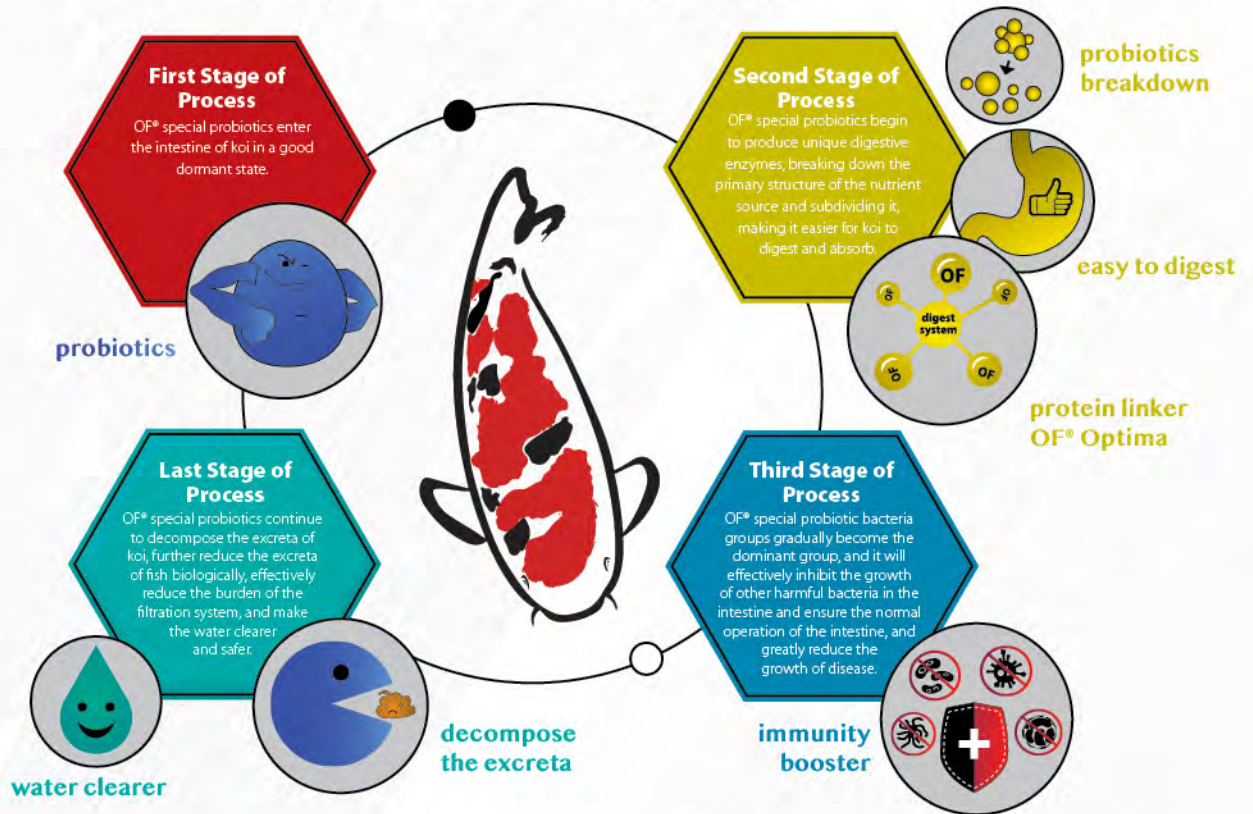

Applicable Temperature

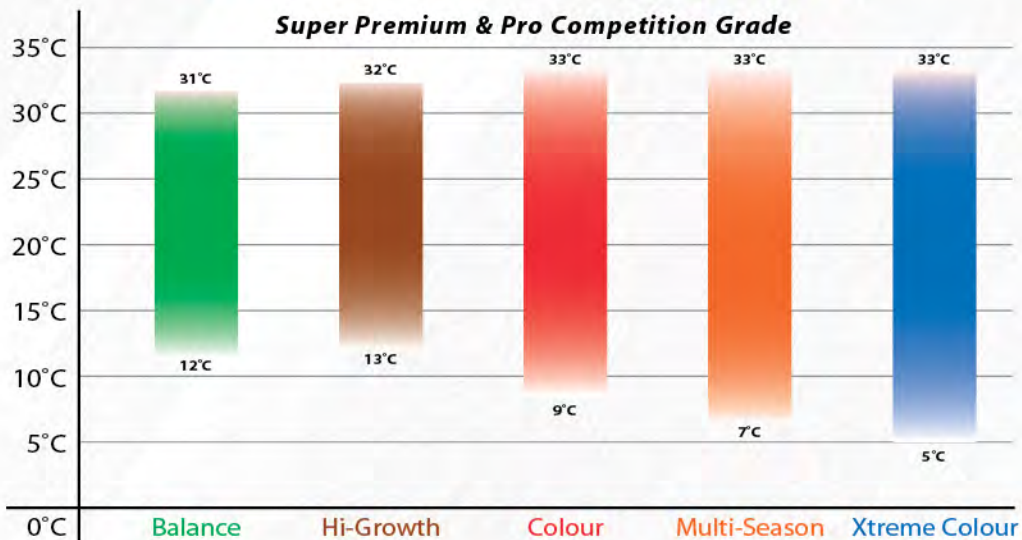



Filtration Comparison Chart

OF® "Kirameki" Feed Super Premium & Pro Competition Grade uses exclusive Koi® protein linker OF® Optima and OF® special beneficial bacteria, it greatly reduces fish excrement.

The protein linker OF® Optima directly increases the absorption of various nutrients by koi by up to 30%, after which the OF® special beneficial bacteria use biological method to quickly decompose fish excrement. After the excrement is subdivided, it then effectively reduce the possibility of organic sludge clogging the filter media and reduce the maintenance rate of the filtration system.

Comparison of actual situation after 14 days



Filter wool condition using general feed

V/S



Filter wool condition using OF® "Kirameki" feed

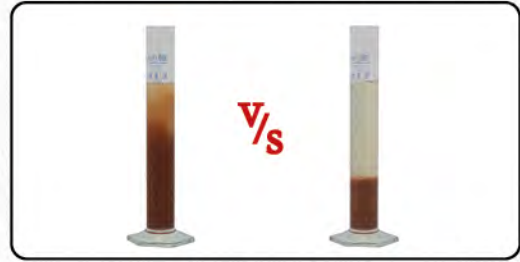

Fish excrement collected from filter wool fed with general food

V/S

Feed fish excrement collected from filter wool fed with OF® "Kirameki"



Experimental Comparison

OF® "Kirameki" feed Super Premium & Pro Competition Grade not only contains QianHu's unique Koi Protein Linker OF® Optima, which increases fish's absorption of various nutrients by more than 30%, it also adds OF® probiotics to further strengthen the koi digestive system. The high content of high-quality protein, natural fat, a variety of minerals and trace elements in the feed provides the daily growth of koi. It does not contain any hormones and chemical hormones. It is pure and natural, it helps growth and plump up the body. It won't be too oily to cause fat accumulation and obesity. If you want koi to grow and have a huge body, please use start to use "Kirameki" high-growth feed.

Fish Farm Control Test



90 days later



Common Koi Feed
13.1cm / 43.38g



XO wheatgerm feed
14.5 - 15.5cm / 63 - 67.3g



OF Kirameki High Growth
17.3 - 18.2cm / 90.2 - 96.8g

Test conditions and situation

Test time	90 days
Test fish Age	less than one year old koi
Water temperature	25°C - 27°C
Feeding Method	3% of Koi's weight



Professional Competition Grade All-round Health Care Feed

OF® "Kirameki" Professional Competition grade all-round health care feed is specially formulated for various environments. You can choose different targeted feeds of "Kirameki" according to your needs, so that your fish can improve and progress towards a champion. Whether it is for growth, shape of the body, the improvement of color, this feed gives very good results. If this feed is used in outdoor ponds or large external ponds, the effect will be even better.

7 ★ ★ ★ ★ ★ ★ ★
Functional Performance of Feed

Pro Balance



Growth	★ ★ ★ ★ ★ ★ ★
Whitening	★ ★ ★ ★ ★ ★ ★
Digestion	★ ★ ★ ★ ★ ★ ★ ★
Health Care	★ ★ ★ ★ ★ ★ ★ ★
Color Enhancement	★ ★ ★ ★ ★ ★ ★
Immunity Booster	★ ★ ★ ★ ★ ★ ★

Pro Colour



Growth	★ ★ ★ ★ ★ ★ ★
Whitening	★ ★ ★ ★ ★ ★ ★
Digestion	★ ★ ★ ★ ★ ★ ★ ★
Health Care	★ ★ ★ ★ ★ ★ ★ ★
Color Enhancement	★ ★ ★ ★ ★ ★ ★
Immunity Booster	★ ★ ★ ★ ★ ★ ★

Pro Hi-Growth



Growth	★ ★ ★ ★ ★ ★ ★ ★
Whitening	★ ★ ★ ★ ★ ★ ★
Digestion	★ ★ ★ ★ ★ ★ ★ ★
Health Care	★ ★ ★ ★ ★ ★ ★ ★
Color Enhancement	★ ★ ★ ★ ★ ★ ★
Immunity Booster	★ ★ ★ ★ ★ ★ ★

Pro Xtreme Colour



Growth	★ ★ ★ ★ ★ ★ ★
Whitening	★ ★ ★ ★ ★ ★ ★
Digestion	★ ★ ★ ★ ★ ★ ★ ★
Health Care	★ ★ ★ ★ ★ ★ ★ ★
Color Enhancement	★ ★ ★ ★ ★ ★ ★
Immunity Booster	★ ★ ★ ★ ★ ★ ★

Pro Multi-Season



Growth	★ ★ ★ ★ ★ ★ ★
Whitening	★ ★ ★ ★ ★ ★ ★
Digestion	★ ★ ★ ★ ★ ★ ★ ★
Health Care	★ ★ ★ ★ ★ ★ ★ ★
Color Enhancement	★ ★ ★ ★ ★ ★ ★
Immunity Booster	★ ★ ★ ★ ★ ★ ★



Super Premium All-round Health Care Feed

OF® "Kirameki" Super Premium all-round health care feed is specially formulated for various environments. You can choose different targeted feeds of "Kirameki" according to your needs, so that your fish can improve and progress towards a champion. Whether it is for growth, shape of the body, the improvement of color, this feed gives very good results. If this feed is used in outdoor ponds or large external ponds, the effect will be even better.

6 ★★★★★
Functional Performance of Feed

Balance



Growth	★★★★
Whitening	★★★★★
Digestion	★★★★★
Health Care	★★★★★
Color Enhancement	★★★
Immunity Booster	★★★★

Colour



Growth	★★★★★
Whitening	★★★★★
Digestion	★★★★★
Health Care	★★★★★
Color Enhancement	★★★★★
Immunity Booster	★★★★★

Hi-Growth



Growth	★★★★★
Whitening	★★★★★
Digestion	★★★★★
Health Care	★★★★★
Color Enhancement	★★★★★
Immunity Booster	★★★★★

Xtreme Colour



Growth	★★★★★
Whitening	★★★★★
Digestion	★★★★★
Health Care	★★★★★
Color Enhancement	★★★★★
Immunity Booster	★★★★★

Multi-Season



Growth	★★★★★
Whitening	★★★★★
Digestion	★★★★★
Health Care	★★★★★
Color Enhancement	★★★★★
Immunity Booster	★★★★★

Professional Competition Grade



Recommended & Suggested Feeding Combinations

The picture below shows the recommended and suggested feeding combinations by koi experts. You can refer to the following scheme and adjust it according to the specific situation of the fish.

Combination A - 1:1:2



Combination B - 1:1



Combination C - 1:1:1



Combination D - 2:1



The combination A / B / C / D - Main achievement goals - For growth and increase body size and color enhancement. When you want koi to grow and at the same time, has the effect of color enhancement, and the water temperature is above 18°C, we suggest you use the above A or B or C or D to accomplish your purpose.

Combination E - 1:1



The main achievement goals - For koi growth, increase body size, and slow color highlight. When you want koi to grow and gain weight, but not in the hurry to enhance the color to the koi and when the water temperature is high, you can choose this combination.

Professional Competition Grade

Recommended & Suggested Feeding Combinations

Combination F - 1:2



Pro Hi-Growth x1

Pro Colour x1

Combination G - 1:1



Pro Hi-Growth x1

Pro Xtreme Colour x1

The main achievement goals - For Koi growth, increase body size and make it more beautiful. When you want koi to grow and gain weight, you can also increase color quickly. At higher temperatures, you can use these two combinations.



Single Feed Recommendation



Pro Multi-Season 100%

The main achievement goal - When water temperature is low, and you want your koi to grow steadily and improve its body shape, and moderately increase its body colors, it is recommended to use this feed.



Pro Xtreme Colour 100%

The main achievement goal - When you wish to make the koi rich in color (red patch) in a short period of time, and greatly improve the gloss of the koi and at the same time, strengthen and brighten the black color, and improve the koi's Growth, body health and body shape, please use this feed.

Super Premium



Recommended & Suggested Feeding Combinations

The picture below shows the recommended and suggested feeding combinations by koi experts. You can refer to the following scheme and adjust it according to the specific situation of the fish.

Combination A - 1:1:2



Combination B - 1:1



Combination C - 1:1:1



Combination D - 2:1



The combination A / B / C / D - Main achievement goals - For growth and increase body size and color enhancement. When you want koi to grow and at the same time, has the effect of color enhancement, and the water temperature is above 18°C, we suggest you use the above A or B or C or D to accomplish your purpose.

Combination E - 1:1



The main achievement goals - For koi growth, increase body size, and slow color highlight. When you want koi to grow and gain weight, but not in the hurry to enhance the color to the koi and when the water temperature is high, you can choose this combination.

Super Premium



Recommended & Suggested Feeding Combinations

Combination F - 1:2



Hi-Growth x1

Colour x2

Combination G - 1:1



Hi-Growth x1

Xtreme Colour x1

The main achievement goals - For Koi growth, increase body size and make it more beautiful. When you want koi to grow and gain weight, you can also increase color quickly. At higher temperatures, you can use these two combinations.



Single Feed Recommendation



Multi-Season 100%

The main achievement goal - When water temperature is low, and you want your koi to grow steadily and improve its body shape, and moderately increase its body colors, it is recommended to use this feed.



Xtreme Colour 100%

The main achievement goal - When you wish to make the koi rich in color (red patch) in a short period of time, and greatly improve the gloss of the koi and at the same time, strengthen and brighten the black color, and improve the koi's Growth, body health and body shape, please use this feed.



KIRAMEKI

Koi Series



Intense Colour

Spirulina

Economy

Growth

Wheatgerm

500g, 1kg & 5kg

OF® KIRAMEKI range of premium Nishikigoi food is a brand-new koi feed that is created to excel in all seasons and function. This revolutionary product range from Qian Hu Koi Nutrition Research is bio-formulated to boost health, growth and beauty of your Koi. Only the finest ingredients are used to ensure that your Koi receives nutrition of the highest quality.

Small Pellet Size:
ø2.7 - 3mm

Medium Pellet Size:
ø5 - 6mm

Large Pellet Size:
ø7 - 8.5mm

Old Packaging



Overall Feed Performance Percentage (%)

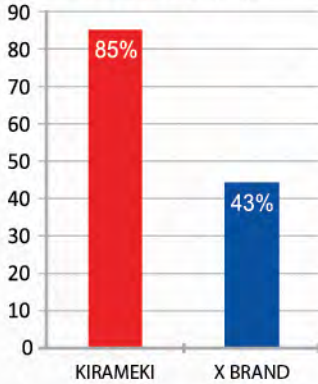

Protein Digestibility / Absorption Percentage (%)

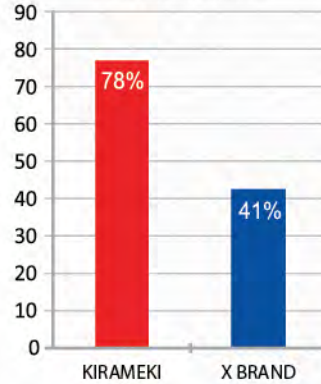

* Graph above is derived from the formula below digestibility of nutrient in test feed (%)

$$= \frac{(A) - (B \times C) \times 100}{D}$$

A = Digestibility of nutrient in Test Feed

B = Digestibility of nutrient in a basal feed

C = Proportion of total nutrient in diet supplied by basal feed

D = Proportion of total nutrient in diet supplied by Test Feed

Code No.**Description****Specification****Packing**

FF928	Economy (floating)	Medium Pellet - 1kg	12 packets/carton
FF929	Economy (floating)	Large Pellet - 1kg	12 packets/carton
FF930	Economy (floating)	Medium Pellet - 5kg	4 packets/carton
FF931	Economy (floating)	Large Pellet - 5kg	4 packets/carton
FF1124	Koi Growth (floating)	Medium Pellet - 500g	24 packets/carton
FF1127	Koi Growth (floating)	Large Pellet - 500g	24 packets/carton
FF1125	Koi Growth (floating)	Medium Pellet - 1kg	12 packets/carton
FF1128	Koi Growth (floating)	Large Pellet - 1kg	12 packets/carton
FF1126	Koi Growth (floating)	Medium Pellet - 5kg	4 packets/carton
FF1129	Koi Growth (floating)	Large Pellet - 5kg	4 packets/carton
FF1097	Spirulina (floating)	Medium Pellet - 500g	24 packets/carton
FF1098	Spirulina (floating)	Large Pellet - 500g	24 packets/carton
FF940	Spirulina (floating)	Medium Pellet - 1kg	12 packets/carton
FF941	Spirulina (floating)	Large Pellet - 1kg	12 packets/carton
FF942	Spirulina (floating)	Medium Pellet - 5kg	4 packets/carton
FF943	Spirulina (floating)	Large Pellet - 5kg	4 packets/carton
FF946	Intense Colour (floating)	Medium Pellet - 1kg	12 packets/carton
FF947	Intense Colour (floating)	Large Pellet - 1kg	12 packets/carton
FF948	Intense Colour (floating)	Medium Pellet - 5kg	4 packets/carton
FF949	Intense Colour (floating)	Large Pellet - 5kg	4 packets/carton
FF1095	Wheatgerm (floating)	Medium Pellet - 500g	24 packets/carton
FF1096	Wheatgerm (floating)	Large Pellet - 500g	24 packets/carton
FF934	Wheatgerm (floating)	Medium Pellet - 1kg	12 packets/carton
FF935	Wheatgerm (floating)	Large Pellet - 1kg	12 packets/carton
FF936	Wheatgerm (floating)	Medium Pellet - 5kg	4 packets/carton
FF937	Wheatgerm (floating)	Large Pellet - 5kg	4 packets/carton

KIRAMEKI - GOLDFISH SERIES

OF KIRAMEKI Goldfish Series is a premium goldfish feed enriched with high protein, fatty acids, minerals, vitamin and OF® Optima that promotes excellent head-formation, body growth, body-shape, superior growth and finnage development. This highly digestible diet suitable for all growth stages of your beloved goldfish.

In addition it contains natural ingredients that enhance coloration. This revolutionary product from Qian Hu Research uses only the finest ingredients to ensure that your goldfish receives nutrition of the highest quality.



Small Pellet Size:
ø2mm



FF1133



FF1132



Code No.	Description	Specification	Packing
FF1132	Oranda	Small Pellet-300g	36 packets/carton
FF1133	Lionhead	Small Pellet-350g	36 packets/carton

AR-G1 | Arowana Carnivorous Pellet

Contain OF® Opti-AR (Metabolic Enhancer)
* Natural Ingredients; Guaranteed no hormones added.

OF® AR-G1 is a premium Arowana carnivorous pelleted feed that excels in all grow-out conditions and function. This revolutionary product from Qian Hu Arowana Nutrition Research is bio-formulated to boost health, growth and beauty of your Arowana. We have analysed the amino acid profile of Arowanas and blended this formulation especially for Arowanas. This feed contains purely highly digestible and absorbable aquatic animal protein that is easily metabolized by the Arowana carnivorous digestive system. Our formulation improves the palatability by 60%, you will only need very short acclimatization period. Only the finest ingredients are used to ensure that your Arowana receives nutrition of the highest quality.

Features :

• Enriched with OF® OptiAR

Carnivorous Metabolic Enhancer that enhances Food Conversion Rate (FCR), increases the palatability (by 60%), boosts growth, improves health, and reduces mortality.

• Fortifies immune system

OF® AR-G1 is bio-formulated to fortify the Arowana's immune system for better health and extra resistance against sickness and viral diseases.

• Enhances growth through superior digestive

Performance OF® AR-G1 helps maintain superior digestive performance during high levels of feeding.

• Superior colour enhancement

OF® AR-G1 is rich with natural ingredients that brings out and intensifies your Arowana's colour.

• No Artificial chemical colouring / enhancer added

No artificial chemical colouring agent is added, the pellet encompasses only colours originating from natural organic sources.

• Pure animal protein feed

All proteins otherwise is pure highly digestible aquatic animal protein that can be metabolize by the Arowana carnivorous digestive system.

• Better water quality

As a result of high FCR and our proprietary binder This floating type pellet also does not cloud your pond / tank water.



Code No.	Specification	Packing
FF909	Small Pellet-20g	300 packets/carton
FF910	Large Pellet-20g	300 packets/carton
FF911	Small Pellet-250g	48 cans/carton
FF912	Large Pellet-250g	48 cans/carton
FF913	Small Pellet-500g	24 cans/carton
FF914	Large Pellet-500g	24 cans/carton
FF915	Small Pellet-1kg	12 cans/carton
FF916	Large Pellet-1kg	12 cans/carton
FF917	Refill Pack-Small Pellet-1kg	12 packets/carton
FF918	Refill Pack-Large Pellet-1kg	12 packets/carton



AR-G2 | Pro Arowana Intense Colour

Contain OF® Opti-AR-X (Metabolic Enhancer)
* Natural Ingredients; Guaranteed no hormones added.

OF® AR-G2 INTENSE COLOUR is a premium Arowana carnivorous pelleted feed that excels in all grow-out conditions and enhanced with our proprietary colour enhancing, body shaping and fin elongation OF® OptiAR-X protein linker. This revolutionary product from Qian Hu Arowana Nutrition Research is bio-formulated to boost health, growth and beauty of your Arowana. Not only will OF® OptiAR-X deliver natural colour pigment to the desired location in the fish body and not the whole fish, OF® OptiAR-X also has the capability of transporting all essential amino acids to the fins and specific body parts so as to help in the fin growth/elongation and body shape for your beloved Arowana. We have analysed the amino acid profile of Arowanas and blended this formulation especially for Arowanas. This feed contains purely highly digestible and absorbable protein that is easily metabolized by the Arowana carnivorous digestive system. Only the finest ingredients are used to ensure that your Arowana receives nutrition of the highest quality.

Features :

• Enriched with OF® OptiAR-X

Carnivorous Metabolic Enhancer that enhances Food Conversion Rate (FCR), increases the palatability (by 60%), boosts growth, improves health, reduces mortality, colour enhancing, fin elongation and body shaping.

• Fortifies immune system

OF® AR-G2 is bio-formulated to fortify the Arowana's immune system for better health and extra resistance against parasitic sickness and viral diseases.

• Enhances growth through superior digestive performance

OF® AR-G2 helps maintain superior digestive performance during high levels of feeding.

• No Artificial chemical colouring / enhancer added

No artificial chemical colouring agent is added, the pellet encompasses only colours originating from natural organic sources.

• Superior colour enhancement

OF® AR-G2 is rich with natural ingredients that brings out and intensifies your Arowana's colour.

• Pure digestible protein feed

All proteins otherwise is pure highly digestible aquatic animal protein that can be metabolize by the Arowana carnivorous digestive system.

• Better water quality

As a result of high FCR and our proprietary binder, this floating type pellet also does not cloud your pond / tank water.



Code No.	Specification	Packing
FF1043	Small Pellet-20g	300 packets/carton
FF1044	Large Pellet-20g	300 packets/carton
FF1045	Small Pellet-250g	48 cans/carton
FF1046	Large Pellet-250g	48 cans/carton
FF1047	Small Pellet-500g	24 cans/carton
FF1048	Large Pellet-500g	24 cans/carton
FF1049	Small Pellet-1kg	12 cans/carton
FF1050	Large Pellet-1kg	12 cans/carton
FF1167	Refill Pack-Small Pellet-1kg	12 packets/carton
FF1168	Refill Pack-Large Pellet-1kg	12 packets/carton



BP-G1 | Pro Blood Parrot

Contain OF® Opti-BP (Metabolic Enhancer)
* Natural Ingredients; Guaranteed no hormones added.

BP-G1 Blood Parrot pellet is the latest technological breakthrough in fish nutrition for Blood Parrot Fish. Our feed will improve the colour development in your beloved Blood Parrot and also improve the contour of the Nuchal Hump.

This feed is specially formulated to suit the unique development of hybrid fishes such as Blood Parrot fish and is suitable for all Blood Parrots or King Kong Parrot breeds. Most importantly, BP-G1 Blood Parrot pellet is a guaranteed hormone-free product that uses only the finest ingredients to ensure that your blood parrot receives nutrition of the highest quality.

Features :

- BP-G1 Blood Parrot pellet is a state-of-the-art scientifically formulated fish feed that will induce speedy head growth and colour development for the juvenile Blood Parrots breeds including King Kong Parrot. Contour of the head growth and redness will improve through consistent feeding.
- Our proprietary feed attractant increases palatability to ensure optimal consumption of feed.
- BP-G1 Blood Parrot pellet contains a special Head Growth Enhancing ingredient, this helps in faster overall growth and most importantly the head growth.
- High content of natural Spirulina strains and a cocktail of deep sea zooplankton extracts with other natural color enhancing elements that will improve the fish's coloration in 1-2 weeks.
- Bio-formulated with immune-enhancing substances that fortify your Blood Parrot's immune system for better health and extra resistance against sickness and viral diseases.
- Contains OF® Opti-BP, a thoroughly tested Carnivorous Metabolic Enhancer that enhances the feed's digestibility and absorbability by at least 30%. Opti-BP also improves the growth of the finnage by channeling nutrients to the vertebrate and bones.



Code No.	Specification	Packing
FF1041	Mini Pellet-20g	300 packets/carton
FF1042	Medium Pellet-20g	300 packets/carton
FF980	Mini Pellet-120g	48 cans/carton
FF981	Medium Pellet-120g	48 cans/carton
FF982	Mini Pellet-250g	48 cans/carton
FF983	Medium Pellet-250g	48 cans/carton
FF984	Mini Pellet-500g	24 cans/carton
FF985	Medium Pellet-500g	24 cans/carton
FF986	Mini Pellet-1kg	12 cans/carton
FF987	Medium Pellet-1kg	12 cans/carton



FH-G1 | Pro Head

Contain OF® Opti-FH (Metabolic Enhancer)
* Natural Ingredients; Guaranteed no hormones added.

FH-G1 ProHead pellet is the latest technological breakthrough in fish nutrition for flowerhorn. It will induce greater development of head growth and improve the contour of the Nuchal Hump. Most importantly, FH-G1 ProHead is a guaranteed hormone-free product that uses only the finest ingredients to ensure that your flowerhorn receives nutrition of the highest quality.

Features :

- FH-G1 ProHead is a unique, state-of-the-art scientifically formulated fish feed to induce rapid head growth for all flowerhorn breeds. Shape of head growth will also improve through consistent feeding. Feed concurrently with FH-G1 ProRedsyn to get the best result.
- Our proprietary feed attractant increases palatability to ensure optimal consumption of feed.
- FH-G1 ProHead contains a special Head Growth Enhancing ingredient, this helps in faster overall growth and most importantly the head growth.
- High content of Spirulina and deep sea zooplankton extracts with other natural color enhancing elements that will improve the fish's sparkle dots in 1-2 weeks.
- Bio-formulated with immune-enhancing substances that fortify your flowerhorn's immune system for better health and extra resistance against sickness and viral diseases.
- Contains OF® Opti-FH, a thoroughly tested Carnivorous Metabolic Enhancer that enhances the feed's digestibility and absorbability by at least 30%. Opti-FH also improves the growth of the finnage by channeling nutrients to the vertebrate and bones.



500g



250g



120g



20g



Code No.

FF1012
FF1013
FF965
FF966
FF970
FF971
FF972
FF973

Specification

Mini Pellet-20g
Medium Pellet-20g
Mini Pellet-120g
Medium Pellet-120g
Mini Pellet-250g
Medium Pellet-250g
Mini Pellet-500g
Medium Pellet-500g

Packing

300 packets/carton
300 packets/carton
48 cans/carton
48 cans/carton
48 cans/carton
48 cans/carton
24 cans/carton
24 cans/carton



FH-G1 | Pro RedSyn

Contain OF® Opti-FH (Metabolic Enhancer)
* Natural Ingredients; Guaranteed no hormones added.

FH-G1 ProRedSyn pellets is the latest technological breakthrough in fish nutrition for flowerhorn. It is formulated to improve the colour development in your beloved flowerhorn and also improve the contour of the Nuchal Hump. Most importantly, FH-G1 ProRedSyn is a guaranteed hormone-free product that uses only the finest ingredients to ensure that your flowerhorn receives nutrition of the highest quality. This feed is suitable for all flowerhorn or cichlid breeds.

Features :

- FH-G1 ProRedSyn is a unique state-of-the-art scientifically formulated fish feed that will induce speedy head growth and colour development for the new generation RedSyn and other flowerhorn breeds. Contour of the head growth and redness will also improve through consistent feeding.
- Our proprietary feed attractant increases palatability to ensure optimal consumption of feed.
- FH-G1 ProRedSyn not only contain special Head Growth Enhancing ingredient, but also natural Colour Enhancing and Body Contouring additives that will support faster overall growth, colour enhancement and most importantly the head growth.
- High content of Spirulina and deep sea zooplankton extracts with other natural color enhancing elements that will improve the fish's sparkle dots in 1-2 weeks.
- Bio-formulated with immune-enhancing substances that fortify your flowerhorn's immune system for better health and extra resistance against sickness and viral diseases.
- Contains OF® Opti-FH, a thoroughly tested Carnivorous Metabolic Enhancer that enhances the feed's digestibility and absorbability by at least 30%. Opti-FH also improves the growth of the finnage by channeling nutrients to the vertebrate and bones.



500g



250g



120g



20g

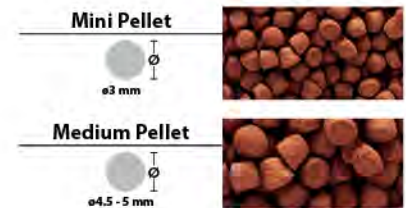

Code No.

FF1014
FF1015
FF974
FF975
FF976
FF977
FF978
FF979

Specification

Mini Pellet-20g
Medium Pellet-20g
Mini Pellet-120g
Medium Pellet-120g
Mini Pellet-250g
Medium Pellet-250g
Mini Pellet-500g
Medium Pellet-500g

Packing

300 packets/carton
300 packets/carton
48 cans/carton
48 cans/carton
48 cans/carton
48 cans/carton
24 cans/carton
24 cans/carton



BF-G1 | Pro Bottom Feeder-Algae Wafer

Contain OF® Opti-BF (Metabolic Enhancer)
* Natural Ingredients; Guaranteed no hormones added.

BF-G1 Bottom Feeder-algae wafer is the latest technological breakthrough in fish nutrition for specialized for Bottom Feeder Fish. Bottom Feeders are detritivores with a unique mode of feeding and also a special nutritional requirement due to the widespread presence of detritus in their natural habitats. Our feed is formulated to ensure that the bottom feeders will be able to grow rapidly solely on BF-G1 as the only feed intake and absorb all the necessary nutrients provided. BF-G1 will also improve the colour development in your beloved Bottom feeders and at the same time ensure sexual maturation when they reach adulthood.

This feed is specially formulated to suit the unique development of Bottom Feeder fishes including all Plecostomus species (including all L-series fishes), all Corydoras species, all Loaches (including all Botia species), all Algae eaters (including all Otocinclus species), all Catfishes (including the large catfishes species), all Bottom Feeding Cyprinids (including Labeos species) and some Freshwater Stingrays and many other species. Most importantly, BF-G1 Bottom Feeder pellet is a guaranteed hormone-free product that uses only the finest ingredients to ensure that your Bottom feeders receive nutrition of the highest quality.

Features :

- BF-G1 Bottom Feeder-algae wafer is a state-of-the-art scientifically formulated fish feed specially for bottom feeders.
- Our proprietary feed attractant increases palatability to ensure optimal consumption of feed.
- BF-G1 Bottom Feeder algae wafer contains a cocktail of nutrients from various sources to ensure that your fish will receive a wholesome meal that ensures rapid growth and development.
- High content of Spirulina, Algal meal and Krill extracts with other natural color enhancing elements that will improve the fish's coloration in 1-2 weeks.
- Bio-formulated with immune-enhancing substances that fortify your fish's immune system for better health and extra resistance against sickness and viral diseases.
- Contains OF® Opti-BF, a thoroughly tested Omnivorous Metabolic Enhancer that enhances the feed's digestibility and absorbability by at least 30%. Opti-BF also improves the growth of the finnage by channeling nutrients to the vertebrate and bones.



250g



120g



60g



20g



Code No.

Specification

Packing

FF1024	Small Wafer-20g	300 packets/carton
FF1025	Large Wafer-20g	300 packets/carton
FF988	Small Wafer-60g	60 cans/carton
FF1026	Large Wafer-60g	60 cans/carton
FF989	Small Wafer-120g	48 cans/carton
FF1027	Large Wafer-120g	48 cans/carton
FF990	Small Wafer-250g	48 cans/carton
FF1028	Large Wafer-250g	48 cans/carton



BF-G1 5KG Available

MF-G1 | Pro Marine Fish

Contain OF® Opti-MF (Metabolic Enhancer)
* Natural Ingredients; Guaranteed no hormones added.

MF-G1 Marine fish pellet is the latest technological breakthrough in Marine fish nutrition for all carnivorous and omnivorous marine fishes. It is formulated to meet their special requirements in amino acid and lipid intake and also the types of carotenoids that they can utilize. More importantly, it provides the different minerals and vitamins required for optimum growth. Marine fishes require very high protein and calcium intake demand especially when they are at the juvenile stage. Marine fishes also have a high demand for Astaxanthin and other carotenoids needed for colour development. Our feed is formulated to ensure that all Marine fishes will be able to grow rapidly optimally depending on MF-G1 as the only feed intake and absorb all the necessary nutrients provided. MF-G1 will also improve the colour development in your Marine fishes and at the same time ensure sexual maturation when they reach adulthood.

This feed is specially formulated to suit the unique development of many Marine fishes including Angelfish (Large), Angelfish (Dwarf), Anthias, Bass & Groupers, Basslets & Assessor, Batfish, Blennies, Boxfish & Pufferfish, Butterflyfish, Cardinalfish, Chromis, Clownfish, Damsels, Dartfish, Dragonets, Filefish, Goatfish, Gobies, Grunts, Hamlet, Hawkfish, Hogfish, Jacks, Parrotfish, Pipefish, Pseudochromis, Rabbitfish, Seahorse, Tangs, Tilefish, Triggerfish and Wrasses. Most importantly, MF-G1 Marine Fish pellet is a guaranteed hormone-free product that uses only the finest ingredients to ensure that your Marine fish receive nutrition of the highest quality.

Features :

- MF-G1 Marine fish pellet is a state-of-the-art scientifically formulated fish feed specially for many species of Marine fishes.
- Our proprietary feed attractant increases palatability to ensure optimal consumption of feed.
- MF-G1 Marine fish pellet contains a cocktail of nutrients from various sources to ensure that your fish will receive a wholesome meal that ensures rapid growth and development.
- High content of Spirulina and Krill extracts with other natural color enhancing elements that will improve the fish's coloration in 1-2 weeks.
- Bio-formulated with immune-enhancing substances that fortify your fish's immune system for better health and extra resistance against sickness and viral diseases.
- Contains OF® Opti-MF, a thoroughly tested Omnivorous Metabolic Enhancer (for Marine Fish) that enhances the feed's digestibility and absorbability by at least 30%. Opti-MF also improves the growth of the finnage by channeling nutrients to the vertebrate and bones.



250g



120g



60g



20g

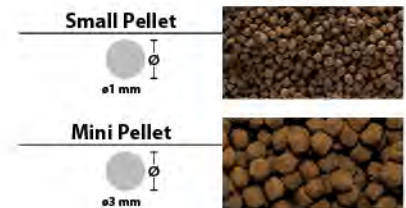

Code No.

FF1029
FF1030
FF992
FF1031
FF993
FF1032
FF994
FF1033

Specification

Small Pellet-20g
Mini Pellet-20g
Small Pellet-60g
Mini Pellet-60g
Small Pellet-120g
Mini Pellet-120g
Small Pellet-250g
Mini Pellet-250g

Packing

300 packets/carton
300 packets/carton
60 cans/carton
60 cans/carton
48 cans/carton
48 cans/carton
48 cans/carton
48 cans/carton



SA-G1 | Pro Monster Fishes Carnivore

(Floating / Sinking)

Contain OF® Opti-SA (Metabolic Enhancer)
* Natural Ingredients; Guaranteed no hormones added.

SA-G1 Monster Fishes stick is the latest technological breakthrough in fish nutrition for big Predatory fishes. Predatory fishes have very high protein and calcium intake demand especially when they are at the juvenile stage. This is because these carnivorous giants need to grow rapidly when young in order not to be eaten by other predators. Our feed is formulated to ensure that all Predatory fishes will be able to grow rapidly solely depending on SA-G1 as the only feed intake and absorb all the necessary nutrients provided. SA-G1 will also improve the colour development in your Predatory Fishes and at the same time ensure sexual maturation when they reach adulthood.

This feed is specially formulated to suit the unique development of Predatory fishes including all South American Arowana species (including Arapaima species), all Garfish species, all Large Catfishes species, all South American Cichlids, All Central American Cichlids, all snakeheads species, all wolf fish species, all lungfishes species, all bass species, Large Characin species, and some freshwater stingrays. Most importantly, SA-G1 Monster Fishes stick is a guaranteed hormone-free product that uses only the finest ingredients to ensure that your Bottom feeders receive nutrition of the highest quality.

Features :

- SA-G1 Monster Fishes stick is a state-of-the-art scientifically formulated fish feed specially for large predatory fishes.
- Our proprietary feed attractant increases palatability to ensure optimal consumption of feed.
- SA-G1 Monster Fishes stick contains a cocktail of nutrients from various sources to ensure that your fish will receive a wholesome meal that ensures rapid growth and development.
- High content of Spirulina and Krill extracts with other natural color enhancing elements that will improve the fish's coloration in 1-2 weeks.
- Bio-formulated with immune-enhancing substances that fortify your fish's immune system for better health and extra resistance against sickness and viral diseases.
- Contains OF® Opti-SA, a thoroughly tested Carnivorous Metabolic Enhancer that enhances the feed's digestibility and absorbability by at least 30%. Opti-SA also improves the growth of the finnage by channeling nutrients to the vertebrate and bones.



Code No.	Specification	Packing
FF1034	Small Stick-20g (Floating)	300 packets/carton
FF1035	Large Stick-20g (Floating)	300 packets/carton
FF997	Small Stick-250g (Floating)	48 cans/carton
FF998	Large Stick-250g (Floating)	48 cans/carton
FF999	Small Stick-500g (Floating)	24 cans/carton
FF1000	Large Stick-500g (Floating)	24 cans/carton
FF1001	Small Stick-1kg (Floating)	12 cans/carton
FF1002	Large Stick-1kg (Floating)	12 cans/carton
FF1108	Large Pellet-250g (Sinking)	48 cans/carton
FF1109	Large Pellet-500g (Sinking)	24 cans/carton



DS-G1 | Pro Discus

Contain OF® Opti-DS (Metabolic Enhancer)
* Natural Ingredients; Guaranteed no hormones added.

DS-G1 Discus fish pellet is the latest technological breakthrough in fish nutrition for omnivorous cichlid especially for the Discus fish. Discus fish's natural habitat includes the floodplains of the Amazon where animal and plant proteins are scarce. They have very selective sensory taste and require very high protein and calcium intake demand especially when they are at the juvenile stage. Discus fishes also have a high demand for Astaxanthin and other carotenoids where they are needed for colour development. Our feed is formulated to ensure that all strains of Discus fishes will be able to grow rapidly solely depending on DS-G1 as the only feed intake and absorb all the necessary nutrients provided. DS-G1 will also improve the colour development in your Discus fishes and at the same time ensure sexual maturation when they reach adulthood. DS-G1 also contains our proprietary feed attractant to ensure the optimal consumption of our feed by the Discus.

This feed is specially formulated to suit the unique development of Discus fishes including all strains like Red Melon strains, Blue Turquoise strains, all the Albino strains, Pigeon Blood strains, all the Wild Discus and many more. It is also suitable for all Cichlids. Most importantly, DS-G1 Discus Fish pellet is a guaranteed hormone-free product that uses only the finest ingredients to ensure that your Discus fish receive nutrition of the highest quality.

Features :

- DS-G1 Discus fish pellet is the state-of-the-art scientifically formulated fish feed that is design and formulated specially for all strains of Discus fishes.
- Our proprietary feed attractant increases palatability to ensure optimal consumption of feed.
- DS-G1 Discus fish pellet contains a cocktail of nutrients from various sources to ensure that your fish will receive a wholesome meal that will ensure rapid growth and development.
- High content of Spirulina and Krill extracts with other natural color enhancing elements that will improve the fish's coloration in 1-2 weeks.
- Bio-formulated with immune-enhancing substances that fortify your fish's immune system for better health and extra resistance against sickness and viral diseases.
- Contains OF® Opti-DS, a thoroughly tested Omnivorous Metabolic Enhancer that enhances the feed's digestibility and absorbability by at least 30%. Opti-DS also improves the growth of the finnage by channeling nutrients to the vertebrate and bones.



250g



120g



60g



20g

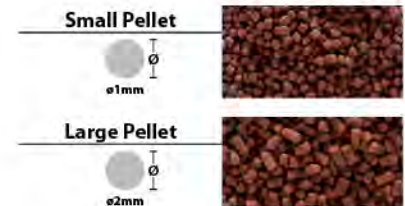

Code No.

Specification

Packing

FF1036	Small Pellet-20g	300 packets/carton
FF1037	Large Pellet-20g	300 packets/carton
FF1003	Small Pellet-60g	60 cans/carton
FF1038	Large Pellet-60g	60 cans/carton
FF1004	Small Pellet-120g	48 cans/carton
FF1039	Large Pellet-120g	48 cans/carton
FF1005	Small Pellet-250g	48 cans/carton
FF1040	Large Pellet-250g	48 cans/carton



DS-G1 5KG Available

MN-G1 | Pro Miniature Fish

Contain OF® Opti-MN (Metabolic Enhancer)
* Natural Ingredients; Guaranteed no hormones added.

MN-G1 Pro Miniature Fish micro pellet is the latest technological breakthrough in fish nutrition for most small-sized tropical fish in your community aquarium. MN-G1 provides a complete nutritional diet that promotes healthy fish growth, strengthens immune system, increases vitality and at the same time ensures sexual maturation when they reach adulthood. It contains Spirulina and natural colour enhancers that improve the colour development.

All ingredients are carefully selected with consideration to their weaker digestive system. MN-G1 also contains OF® Opti-MN, a thoroughly tested Metabolic Enhancer that further aids the digestion and absorption of nutrients by 30%.

This feed is specially formulated to suit the development of the small-sized tropical fish that includes all live-bearers, labyrinth fishes, gobies, killifish, rainbowfish and darters (example, Guppy, Tetra, Platies, Swordtails and Bettas). We ensure that MN-G1 is hormone-free and uses only the finest ingredients to ensure that your fish receive nutrition of the highest quality.

Special Features:

- MN-G1 Pro Miniature Fish pellet is a state-of-the-art scientifically formulated fish feed for small-sized tropical fish that excels in all functions.
- OF® Opti-MN. Contains Opti-MN, a thoroughly tested Metabolic Enhancer that enhances the feed's digestibility and absorbability by at least 30%. The superior feed conversion rate (FCR) of MN-G1 enhances growth while minimizing fish waste to help maintain good water quality.
- Accelerates Growth. Contains a unique blend of ingredients that provides a complete nutritional source of amino acids, protein, calcium, fats, trace elements and stable vitamins ensuring rapid growth and development.
- Boosts Color. High content of Spirulina and natural colour enhancing ingredients that brings-out and improves the beautiful coloration of your fish in 1-2 weeks. The ingredients will also help improve the shine on the scales.
- Increases Vitality. Bio-formulated with immune-enhancing substances that fortify your fish's immune system for better health and extra resistance against sickness and viral diseases.

Micro Granules



120g



60g



20g



Code No.

FF1123

Specification

Micro Granules-20g

Packing

300 packets/carton

FF1114

Micro Granules-60g

60 cans/carton

FF1159

Micro Granules-120g

48 cans/carton



MN-G1 5KG
Available

GF-G1 | Pro GoldFish

Contain OF® Opti-GF (Metabolic Enhancer)
* Natural Ingredients; Guaranteed no hormones added.

GF-G1 Pro Goldfish pellet is the latest technological breakthrough in fish nutrition for the Goldfish formulated after years of research and development with breeders and hobbyist. It contains a unique blend of ingredients that accelerates the overall development of head-formation, body growth, body-shape and finnage, enhancing coloration and shine of your goldfish and at the same time ensure sexual maturation when they reach adulthood. In addition, GF-G1 provides a complete and balanced source of amino acids, protein, calcium, fats, trace elements and stable vitamins that aids the goldfish in fortifying its immune system and increasing its vitality.

All ingredients are carefully selected with consideration to the Goldfish's unique digestive system, ensuring easy digestion and rapid absorption of nutrients. GF-G1 also contains OF® Opti-GF, a thoroughly tested Metabolic Enhancer that further enhances the feed's digestibility and absorbability by at least 30%.

This feed is specially formulated to suit the exceptional development of goldfish breeds including Ranchu, Oranda, Ryukin, Lionhead and Telescope. Most importantly, GF-G1 Pro Goldfish pellet ensures our hormone-free product uses only the finest ingredients to provide the best nutrition to your goldfish.

Special Features:

- GF-G1 Pro Goldfish pellet is a state-of-the-art scientifically formulated fish feed for goldfish that excels in all functions.
- OF® Opti-GF. Contains Opti-GF, a thoroughly tested Metabolic Enhancer that enhances the feed's digestibility and absorbability by at least 30%.GF-G1 helps reduce the occurrence of common illnesses caused by indigestion by up to 80%.
- Accelerates Growth. Contains a unique blend of ingredients that encourages a rapid but balanced development of head-formation, overall body growth, body-shape and finnage. Opti-GF also further improves the growth of the finnage by channeling nutrients to the vertebrae and bones.
- Boosts Color. High content of colour enhancing natural ingredients that brings-out, intensifies and maintains your goldfish's coloration. The ingredients will also help improve the shine on the scales.
- Increases Vitality. Bio-formulated with immune-enhancing substances that fortify your goldfish's immune system for better health and extra resistance against sickness and viral diseases.



Code No.	Specification	Packing
FF1121	Sinking-20g	300 packets/carton
FF1122	Floating-20g	300 packets/carton
FF1115	Sinking-120g	48 cans/carton
FF1116	Floating-120g	48 cans/carton
FF1117	Sinking-250g	48 cans/carton
FF1118	Floating-250g	48 cans/carton
FF1119	Sinking-500g	24 cans/carton
FF1120	Floating-500g	24 cans/carton



TT-G1 | Pro Terrapins And Turtles Pellet

Contain OF® Opti-TT (Metabolic Enhancer)
* Natural Ingredients; Guaranteed no hormones added.

TT-G1 Terrapins and Turtles pellet is the latest technological breakthrough in nutrition for all terrapins and turtles. Terrapins and turtles are unique amphibians with both internal and external skeletal bones and require very high protein and calcium intake demand especially at the juvenile stage. Their digestive system and nutritional demands are different from other aquatic animals. TT-G1 is formulated to ensure all terrapins and turtles will be able to obtain all the necessary nutrients, essential vitamins and trace elements for optimal growth. It is also enriched with soluble calcium for healthy bone and shell development. TT-G1 contains all the essential amino acids that is required to ensure sexual maturation when they reach adulthood.

This feed is specially formulated to suit the unique development of all terrapins like red ear sliders, all box turtles, all musk turtles, all mud turtles, all pond turtles, all map turtles, all painted turtles, diamondback terrapins, and all other terrapins and turtles around the world. Most importantly, TT-G1 Terrapins and Turtles pellet is a guaranteed hormone-free product that uses only the finest ingredients to ensure that your terrapins and turtles receive nutrition of the highest quality.

Special Features:

- TT-G1 Terrapins and Turtles pellet is a state-of-the-art scientifically formulated with a cocktail of nutrients from various sources to ensure that your terrapins and turtle receive a wholesome meal, ensuring rapid growth and development
- Contains Vitamin A that helps prevent swollen eyelids, a common turtle disease caused by Vitamin A deficiency.
- High content of soluble calcium to ensure healthy and optimal internal and external bone and shell development.
- Bio-formulated with immune-enhancing substances and vitamins that fortify your terrapins and turtle's immune system for better health, extra vitality and resistance against sickness and viral diseases.
- Contains OF® Opti-TT, a thoroughly tested Carnivorous Metabolic Enhancer that enhances the feed's digestibility and absorbability by at least 30%.
- TT-G1 is formulated to ensure that it does not cloud water and reduces undesirable smell in the water.
- TT-G1 does not contain any artificial colours and flavours



500g



250g



120g



60g



20g

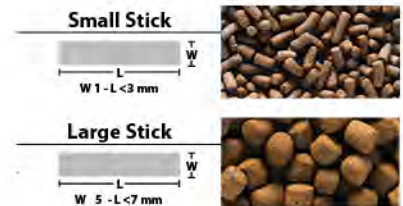

Code No.	Specification	Packing
FF1147	Small Stick-20g	300 packets/carton
FF1148	Large Stick-20g	300 packets/carton
FF1149	Small Stick-60g	60 cans/carton
FF1150	Large Stick-60g	60 cans/carton
FF1151	Small Stick-120g	48 cans/carton
FF1152	Large Stick-120g	48 cans/carton
FF1153	Small Stick-250g	48 cans/carton
FF1154	Large Stick-250g	48 cans/carton
FF1155	Small Stick-500g	24 cans/carton
FF1156	Large Stick-500g	24 cans/carton



BT-G1 | Pro Betta

Contain OF® Opti-BT (Metabolic Enhancer)
* Natural Ingredients; Guaranteed no hormones added.

Specially formulated for all Betta types, BT-G1 is a breakthrough in betta nutrition that provides a complete nutritional diet that promotes healthy growth and fin development, boosts color, strengthens immune system, increases vitality and stamina of Betta. Only the finest ingredients are used to ensure that your fish receive nutrition of the highest quality.

Special Features :

- **Contains OF® Opti-BT.** Metabolic Enhancer that enhances the feed's digestibility and absorbability by at least 30%. The superior feed conversion rate (FCR) enhances growth while minimizing fish waste to help maintain good water quality.
- **Accelerates Growth.** Contains a unique blend of ingredients that provides a complete nutritional source of amino acids, protein, calcium, fats, trace elements and stable vitamins ensuring rapid growth and fin development.
- **Boosts Color.** High content of Spirulina and natural colour enhancing ingredients that brings out and improves the beautiful coloration of your fish in 1-2 weeks. The ingredients will also help improve the shine on the scales.
- **Increases Stamina and Vitality.** Bio-formulated with immune-enhancing substances that fortify your fish's immune system for better health and extra resistance against sickness and viral diseases.

秘仔
方湖



20g



5g



Micro Granules



≤0.8mm



Small Pellet



1mm



Small



Micro Granules

Code No.

FF1173
FF1174
FF1171
FF1172

Specification

Micro Granules-5g
Small-5g
Micro Granules-20g
Small-20g

Packing

300 packets/carton
300 packets/carton
60 cans/carton
60 cans/carton

INSTA FRESH SERIES

High Pressure Heat Steam Sterilization



- A new nutritional alternative to traditional frozen fish feed!
- Fortified with calcium, minerals and vitamins for better growth
- Densely packed to ensure you aren't paying for water
- Parasite Free
- Virus Free
- Bacteria Free
- Fungus Free
- High Pressure Heat Steam Sterilization
- The practical substitute to frozen food
- Nutritional value is double that of frozen food
- Does not cloud aquarium water

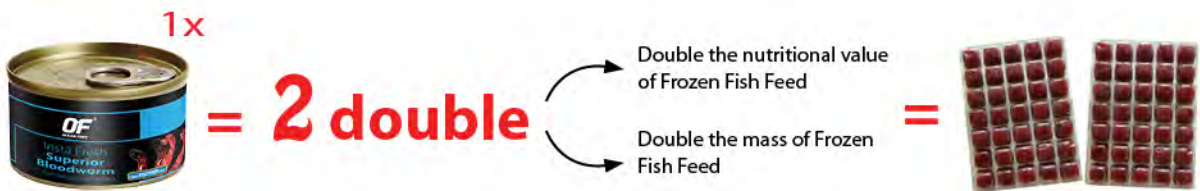

Code No.	Description	Specification	Packing
FF1051	Superior Bloodworm	100g	48 cans/carton
FF1053	Quality Artemia Brine Shrimp	100g	48 cans/carton
FF1055	Finest Arctic Shrimp (seasonal)	100g	48 cans/carton
FF1057	Premium Cyclops	100g	48 cans/carton
FF1112	Prime Krill	100g	48 cans/carton

T1-SUPER BITS

A slow sinking granular food for mid level and bottom dwelling fishes.

- Enhance fish shape
- Intensify natural color
- Special immune substance added
- Will not pollute water

Code No.	Specification	Packing
OFFF488	Granules-10g	600 packets/carton
OFFF437	Granules-110ml/45g	60 bottles/carton
OFFF438	Granules-280ml/110g	48 bottles/carton
OFFF439	Granules-1100ml/450g	12 bottles/carton



OFFF439 OFFF438 OFFF437 OFFF488

T2-SUPER COLOR

An absolute fish feed for tropical fishes.

- Great color development
- Nourishing everyday feed
- Immune substance added
- Will not pollute water

Code No.	Specification	Packing
OFFF583	Flakes-5g	600 packets/carton
OFFF443	Flakes-110ml/22g	60 bottles/carton
OFFF444	Flakes-280ml/58g	48 bottles/carton
OFFF445	Flakes-1100ml/220g	12 bottles/carton



OFFF445 OFFF444 OFFF443 OFFF583

T3-SUPER MINERAL

An absolute diet for tropical fishes.

- Wholesome nutritional feed
- Induce growth rate
- Special immune substance added
- Will not pollute water

Code No.	Specification	Packing
OFFF582	Flakes-5g	600 packets/carton
OFFF440	Flakes-110ml/22g	60 bottles/carton
OFFF441	Flakes-280ml/58g	48 bottles/carton
OFFF442	Flakes-1100ml/220g	12 bottles/carton



OFFF442 OFFF441 OFFF440 OFFF582

T4-SUPER TROPICALBIT

A superior fish feed for tropical fishes.

- Great for color development
- Nourishing daily feed
- Immune substance added
- Will not pollute water

Code No.	Specification	Packing
OFFF499	Granules-10g	600 packets/carton
OFFF500	Granules-110ml/28g	60 bottles/carton
OFFF501	Granules-280ml/70g	48 bottles/carton
OFFF502	Granules-1100ml/280g	12 bottles/carton



OFFF502 OFFF501 OFFF500 OFFF499

T5-SUPER TROPICPELLET

An absolute color-enhancing pellet feed for all tropical fishes.

- Great for color development
- High nutritional content for growth
- Special formulated for tropical fishes
- Immune substance added
- Will not pollute water

Code No.	Specification	Packing
OFFF590	Mini Pellet-20g	360 packets/carton
OFFF543	Baby Pellet-110ml/60g	60 bottles/carton
OFFF544	Mini Pellet-280ml/130g	48 bottles/carton
OFFF545	Mini Pellet-550ml/240g	24 bottles/carton



OFFF545 OFFF544 OFFF543 OFFF590

T6-SUPER MINIATURE

A superior granules feed for Tetra fishes and small sized fishes.

- Excellent palatability, finely grinded and easy digestible
- Great for color development
- Nourishing feed to provide vigor and health
- Balance feed for growth
- Healthier and shiner scales after constant feed
- Immune substance added
- Will not pollute water

Code No.	Specification	Packing
OFFF591	Micro Granules-10g	600 packets/carton
OFFF534	Micro Granules-110ml/70g	60 bottles/carton



OFFF534 OFFF591

T7-SUPER BABY

Nutritional fine feeds for all tropical baby fishes.

- All essential minerals and vitamins added for the crucial growing up stage of all baby fishes
- Specially grinded into fine bits for easy feeding and digestive
- Promote natural development of colour for the fishes
- Highly receptive by all fishes and high protein content
- Special immune substance added
- Will not cloud water

Code No.	Specification	Packing
OFFF654	Powder Form-10g	600 packets/carton
OFFF503	Powder Form-110ml/60g	60 bottles/carton



OFFF503 OFFF654

T8-SUPER NEO-GLO FISH FLAKES

An absolute fish flakes for neo-glo fish :

- Formulated with special ingredients which will make your Neo-Glo fish glow more brightly.
- Specially selected protein fluorescence, ensuring your Neo-Glo fish shine brilliantly.
- Immune substance added.
- Will not pollute water.
- Suitable for other tropical fish as well.

Code No.	Specification	Packing
OFFF1313	Flakes-110ml/45g	60 bottles/carton
OFFF1314	Flakes-280ml/95g	48 bottles/carton



OFFF1313 OFFF1314

C1-SUPER CICHLID

For large carnivorous fishes that demand high nutrition.

- High nutrition and protein for giant fishes
- Natural color enhancement
- Easy to digest and nutritional content absorbed
- Bigger food stick size
- Suitable for all carnivorous fishes
- Will not cloud water
- Special immune substance added

Code No.	Specification	Packing
OFFF504	Sticks-280ml/90g	48 bottles/carton
OFFF505	Sticks-1100ml/350g	12 bottles/carton



C3-SUPER BLOODPARROT

A superior granules feed for Blood Parrot cichlids.

- Great for colour development
- Head growth development feed
- Nourishing feed to provide vigor and health
- Balance feed for growth and improving body shape
- Special immune substance added
- Healthier and shiner scales after constant feed
- Excellent palatability and easy digestible
- Will not pollute water

Code No.	Specification	Packing
OFFF653	Floating Pellet-20g	360 packets/carton
OFFF508	Floating Pellet-280ml/120g	48 bottles/carton
OFFF509	Floating Pellet-550ml/270g	24 bottles/carton



C4-SUPER CICHLID PELLETT

An absolute color-enhancing pellet feed for all cichlids.

- Balanced feed for growth and improving body shapes
- Great for colour development
- Partial sinking type
- Special immune substance added
- Will not pollute water

Code No.	Specification	Packing
OFFF837	Baby Pellet-110ml/60g	60 bottles/carton
OFFF838	Mini Pellet-280ml/120g	48 bottles/carton
OFFF839	Mini Pellet-550ml/250g	24 bottles/carton
OFFF840	Mini Pellet-1100ml/450g	12 bottles/carton



S1-SUPER GUPPY

Special completed food for exotic guppies.

- Enhance fish shape and fin development
- Intensify natural color
- Special immune substance added
- Will not pollute water

Code No.	Specification	Packing
OFFF584	Flakes-5g	600 packets/carton
OFFF450	Flakes-110ml/22g	60 bottles/carton
OFFF603	Flakes-280ml/58g	48 bottles/carton



S2-SUPER PLECORYS

For exotic plecos / corys and bottom feeding catfishes that need constant high nutrition.

- High nutrition content
- Enhanced Spirulina content
- Palatable food waffles
- Vitamin / Mineral enhanced for better growth
- Will not cloud water
- Easy to digest and nutritional content absorbed
- Natural colour enhancer
- Suitable for all plecos and corys
- Special immune substance added

Code No.	Specification	Packing
OFFF659	Tablets-10g	600 packets/carton
OFFF532	Tablets-110ml/40g	60 bottles/carton
OFFF533	Tablets-280ml/100g	48 bottles/carton



OFFF533

OFFF532

OFFF659

S4-SUPER BETTA

An absolute fish diet for Bettas.

- Increase fish's activeness and stamina during confrontation
- Complete nutritional feed
- Special immune substance added
- Color enhancing
- Induce growth rate
- Will not pollute water

Code No.	Specification	Packing
OFFF589	Flakes-5g	600 packets/carton
OFFF449	Flakes-110ml/22g	60 bottles/carton



OFFF449

OFFF589

S5-SUPER CRUSTANORISH

A superior sinking pellet for Hermit Crabs, Crayfishes, Lobsters, Crabs and all Crustaceans.

- Contain calcium elements and strengthening of shell
- Once well fed, it will prevent cannibalism or harming of other tankmates
- Promoting growth, vitality and health
- With super immune substance added
- Complete nutrition and color enhancing capability
- Multi-vitamin / mineral added

Code No.	Specification	Packing
OFFF633	Sinking Pellet-110ml/65g	60 bottles/carton
OFFF658	Sinking Pellet-280ml/165g	48 bottles/carton



OFFF658

OFFF633

S6-SUPER BETTA PELLET

An absolute color-enhancing pellet for bettas.

- Great color development
- Special immune substance added
- High nutritional for betta fishes
- For enhancement of fin shape
- Will not pollute water

Code No.	Specification	Packing
OFFF848	Baby Pellet-110ml/60g	60 bottles/carton
OFFF849	Baby Pellet-280ml/135g	48 bottles/carton



OFFF849

OFFF848

M1-SUPER MARINE

A superior fish feed for tropical marine fishes.

- Readily acceptable by all surface, middle and bottom swimming marine fishes
- Fine granules feed that has different sinking rate
- Vitamins and minerals added
- Nourishing daily feed
- Will not pollute water
- Great for colour development and growth
- Special immune substance added

Code No.	Specification	Packing
OFFF585	Granules-10g	600 packets/carton
OFFF506	Granules-110ml/40g	60 bottles/carton
OFFF507	Granules-280ml/115g	48 bottles/carton



OFFF507

OFFF506

OFFF585

R1-SUPER REPTILE

Ocean Free Super Reptile is a nutritional based floating food sticks that:

Suitable for Amphibians, Exotic Frogs, Terrapins, Newts and any other Water Reptiles.

- Comes with complete nutritional for steady growth
- Added with special immune substance
- Improvement of health
- High in vitamin content
- Does not cloud water at all
- Enriched with calcium
- Helps in shell development

Code No.	Specification	Packing
OFFPD381	Floating Food Stick-10g	600 packets/carton
OFFPD342	Floating Food Stick-110ml/35g	60 bottles/carton
OFFPD343	Floating Food Stick-280ml/90g	48 bottles/carton
OFFPD344	Floating Food Stick-1100ml/350g	12 bottles/carton



OFFPD344

OFFPD343

OFFPD342

OFFPD381

R2-SUPER GAMMARUS

Ocean Free Super Gammamus - Suitable for all Turtles / Terrapins and some Reptiles.

- Total nutrition and taste are locked in and will be totally accepted by your pets
- Under constant feeding, your turtles / terrapins will experience speedy growth, improvement in shell development and healthier
- Total 100% natural with high calcium content
- High nutritional value
- Will not cloud water
- Special immune substance added

Code No.	Specification	Packing
OFFPD350	Stream Krill-110ml/12g	60 bottles/carton
OFFPD351	Stream Krill-280ml/27g	48 bottles/carton
OFFPD352	Stream Krill-1100ml/102g	12 bottles/carton



OFFPD352

OFFPD351

OFFPD350

G1-SUPER GOLDFISH - COLOUR ENHANCER

A total colour enhancing floating pellet food for goldfish.

- Enhance goldfish natural colour pigments with high spirulina, carotene and other natural coloration
- High content of Krill extract will result in shiny scales especially red, orange and yellow pigments
- Floating type and will not pollute water
- Special immune substance added
- Suitable for all fancy goldfishes of any sizes

Code No.	Specification	Packing
OFFF586	Floating Pellet-20g	360 packets/carton
OFFF446	Floating Pellet-280ml/120g	48 bottles/carton
OFFF529	Floating Pellet-550ml/260g	24 bottles/carton



OFFF529

OFFF446

OFFF586

G2-SUPER GOLDFISH - NATURAL GROWTH

A total complete balanced growth pellet feed for goldfish.

- Enhance goldfish growth rate with high protein content
- Highly digestible to aid vitamin /mineral absorption and to promote good health
- A must feed to have for growing goldfishes
- Special immune substance added
- Floating type, will not pollute water
- Suitable for all fancy goldfishes of any sizes

Code No.	Specification	Packing
OFFF587	Floating Pellet-20g	360 packets/carton
OFFF447	Floating Pellet-280ml/120g	48 bottles/carton
OFFF530	Floating Pellet-550ml/260g	24 bottles/carton



G3-SUPER GOLDFISH - NATURAL MAINTENANCE

A total complete balanced maintenance diet pellet feed for goldfish.

- Made with wholesome vegetable fibre for good dietary requirements
- High content of wheat germ formula for easy digestive purposes
- Enhance goldfish health and activeness
- Total balance formula for good body shape development
- Aids digestion even at low temperatures
- Special immune substance added
- Floating type, will not pollute water

Code No.	Specification	Packing
OFFF588	Floating Pellet-20g	360 packets/carton
OFFF448	Floating Pellet-280ml/120g	48 bottles/carton
OFFF531	Floating Pellet-550ml/260g	24 bottles/carton



K1-SUPER KOISTICKS

- It is packed with all the essential vitamins for a complete balanced diet
- High palatability that will be readily accepted by your KOIs
- Due to natural colour enhancing formula, it will enhance KOIs colour's vibrancy and maintaining it that way upon constant feeding
- It is highly digestible and therefore reduces water pollution
- Ideal feed for KOIs of all sizes
- Value for money at good quality

Code No.	Specification	Packing
OFFF484	Floating Stick-1100ml/280g	12 bottles/carton
OFFF469	Floating Stick-5 litre/1350g	12 packets/carton
OFFF470	Floating Stick-10 litre/2700g	4 packets/carton



K2-SUPER PONDSTICKS

- It is packed with all the essential vitamins for a complete balanced diet
- High palatability that will be readily accepted by your KOIs
- Due to all the essential nutrients, fish's natural colour will surface and maintained that way
- It is highly digestible and therefore reduces water pollution
- Ideal feed for KOIS / goldfishes of all sizes
- Value for money at good quality

Code No.	Specification	Packing
OFFF465	Floating Stick-1100ml/280g	12 bottles/carton
OFFF472	Floating Stick-5 litre/1350g	12 packets/carton
OFFF473	Floating Stick-10 litre/2700g	4 packets/carton



SUPER BITS

A slow sinking granular food for mid level and bottom dwelling fishes.

- Enhance fish shape
- Intensify natural color
- Special immune substance added
- Will not pollute water

Code No.	Specification	Packing
FF488	Granules-10g	600 packets/carton
FF437	Granules-110ml/45g	60 bottles/carton
FF438	Granules-280ml/110g	48 bottles/carton
FF439	Granules-1100ml/450g	12 bottles/carton



FF488 FF437 FF438 FF439

SUPER COLOR

An absolute fish feed for tropical fishes.

- Great color development
- Nourishing everyday feed
- Immune substance added
- Will not pollute water

Code No.	Specification	Packing
FF583	Flakes-5g	600 packets/carton
FF443	Flakes-110ml/22g	60 bottles/carton
FF444	Flakes-280ml/58g	48 bottles/carton
FF445	Flakes-1100ml/220g	12 bottles/carton



FF583 FF443 FF444 FF445

SUPER MINERAL

An absolute diet for tropical fishes.

- Wholesome nutritional feed
- Induce growth rate
- Special immune substance added
- Will not pollute water

Code No.	Specification	Packing
FF582	Flakes-5g	600 packets/carton
FF440	Flakes-110ml/22g	60 bottles/carton
FF441	Flakes-280ml/58g	48 bottles/carton
FF442	Flakes-1100ml/220g	12 bottles/carton



FF582 FF440 FF441 FF442

SUPER TROPICALBIT

A superior fish feed for tropical fishes.

- Great for color development
- Nourishing daily feed
- Immune substance added
- Will not pollute water

Code No.	Specification	Packing
FF499	Granules-10g	600 packets/carton
FF500	Granules-110ml/28g	60 bottles/carton
FF501	Granules-280ml/70g	48 bottles/carton
FF502	Granules-1100ml/280g	12 bottles/carton



FF499 FF500 FF501 FF502

SUPER TROPICPELLET

An absolute color-enhancing pellet feed for all tropical fishes.

- Great for color development
- High nutritional content for growth
- Special formulated for tropical fishes
- Will not pollute water
- Immune substance added

Code No.	Specification	Packing
FF590	Mini Pellet-20g	360 packets/carton
FF543	Baby Pellet-110ml/60g	60 bottles/carton
FF544	Mini Pellet-280ml/130g	48 bottles/carton
FF545	Mini Pellet-550ml/240g	24 bottles/carton



FF590 FF543 FF544 FF545

SUPER GOLDFISH - COLOUR ENHANCER

A total colour enhancing floating pellet feed for goldfish.

- Enhance goldfish natural colour pigments with high spirulina, carotene content and other natural coloration
- High content of Krill extract will result in shiny scales especially red, orange and yellow pigments
- Floating type and will not pollute water
- Suitable for all fancy goldfishes of any sizes
- Special immune substance added

Code No.	Specification	Packing
FF586	Floating Pellet-20g	360 packets/carton
FF446	Floating Pellet-280ml/120g	48 bottles/carton
FF529	Floating Pellet-550ml/260g	24 bottles/carton



FF586

FF446

FF529

SUPER GOLDFISH - NATURAL GROWTH

A total complete balanced growth pellet feed for goldfish.

- Enhance goldfish growth rate with high protein content
- Highly digestible to aid vitamin / mineral absorption and to promote good health
- A must feed to have for growing goldfishes
- Special immune substance added
- Floating type, will not pollute water
- Suitable for all fancy goldfishes of any sizes

Code No.	Specification	Packing
FF587	Floating Pellet-20g	360 packets/carton
FF447	Floating Pellet-280ml/120g	48 bottles/carton
FF530	Floating Pellet-550ml/260g	24 bottles/carton



FF587

FF447

FF530

SUPER GOLDFISH - NATURAL MAINTENANCE

A total complete balanced maintenance diet pellet feed for goldfish.

- Made with wholesome vegetable fibre for good dietary requirements
- High content of wheat germ formula for easy digestive purposes
- Enhance goldfish health and activeness
- Total balance formula for good body shape development
- Aids digestion even at low temperatures
- Special immune substance added
- Floating type, will not pollute water

Code No.	Specification	Packing
FF588	Floating Pellet-20g	360 packets/carton
FF448	Floating Pellet-280ml/120g	48 bottles/carton
FF531	Floating Pellet-550ml/260g	24 bottles/carton



FF588

FF448

FF531

SUPER REPTILE

Ocean Free Super Reptile is a nutritional based floating food sticks that:

Suitable for Amphibians, Exotic Frogs, Terrapins, Newts and any other Water Reptiles.

- Comes with complete nutritional for steady growth
- Improvement of health
- High in vitamin content
- Added with special immune substance
- Enriched with calcium
- Helps in shell development
- Does not cloud water at all

Code No.	Specification	Packing
PD381	Floating Food Stick-10g	600 packets/carton
PD342	Floating Food Stick-110ml/35g	60 bottles/carton
PD343	Floating Food Stick-280ml/90g	48 bottles/carton
PD344	Floating Food Stick-1100ml/350g	12 bottles/carton



PD344

PD343

PD342

PD381

SUPER GAMMARUS

Ocean Free Super Gammarus - Suitable for all Turtles / Terrapins and some Reptiles.

- Total nutrition and taste are locked in and will be totally accepted by your pets
- Under constant feeding, your turtles / terrapins will experience speedy growth, improvement in shell development and healthier
- Total 100% natural with high calcium content
- High nutritional value
- Special immune substance added
- Will not cloud water

Code No.	Specification	Packing
PD350	Stream Krill-110ml/12g	60 bottles/carton
PD351	Stream Krill-280ml/27g	48 bottles/carton
PD352	Stream Krill-1100ml/102g	12 bottles/carton



PD352 PD351 PD350

SUPER GUPPY

Special completed food for exotic guppies.

- Enhance fish shape and fin development
- Intensify natural color
- Special immune substance added
- Will not pollute water

Code No.	Specification	Packing
FF584	Flakes-5g	600 packets/carton
FF450	Flakes-110ml/22g	60 bottles/carton
FF603	Flakes-280ml/58g	48 bottles/carton



FF584 FF450 FF603

SUPER MARINE

A superior fish feed for tropical marine fishes.

- Readily accepted by all surface, middle and bottom swimming marine fishes
- Fine granules feed that has different sinking rate
- Vitamins and minerals added
- Great for colour development and growth
- Nourishing daily feed
- Special immune substance added
- Will not pollute water

Code No.	Specification	Packing
FF585	Granules-10g	600 packets/carton
FF506	Granules-110ml/40g	60 bottles/carton
FF507	Granules-280ml/115g	48 bottles/carton



FF585 FF506 FF507

SUPER PLECORYS

For exotic plecos / corys and bottom feeding catfishes that need constant high nutrition.

- High nutrition content
- Enhanced Spirulina content
- Palatable food waffles
- Vitamin / Mineral enhanced for better growth
- Will not cloud water
- Easy to digest and nutritional content absorbed
- Natural colour enhancer
- Suitable for all plecos and corys
- Special immune substance added

Code No.	Specification	Packing
FF659	Tablets-10g	600 packets/carton
FF532	Tablets-110ml/40g	60 bottles/carton
FF533	Tablets-280ml/100g	48 bottles/carton



FF533 FF532 FF659

SUPER CICHLID

For large carnivorous fishes that demand high nutrition.

- High nutrition and protein for giant fishes
- Natural color enhancement
- Easy to digest and nutritional content absorbed
- Bigger food stick size
- Suitable for all carnivorous fishes
- Will not cloud water
- Special immune substance added

Code No.	Specification	Packing
FF504	Sticks-280ml/90g	48 bottles/carton
FF505	Sticks-1100ml/350g	12 bottles/carton



FF505

FF504

SUPER MINIATURE

A superior granules feed for Tetra fishes and small sized fishes.

- Excellent palatability, finely grinded and easy digestible
- Great for color development
- Nourishing feed to provide vigor and health
- Balance feed for growth
- Healthier and shiner scales after constant feed
- Immune substance added
- Will not pollute water

Code No.	Specification	Packing
FF591	Micro Granules-10g	600 packets/carton
FF534	Micro Granules-110ml/70g	60 bottles/carton



FF591

FF534

SUPER BETTA

An absolute fish diet for Bettas.

- Increase fish's activeness and stamina during confrontation
- Complete nutritional feed
- Special immune substance added
- Color enhancing
- Induce growth rate
- Will not pollute water

Code No.	Specification	Packing
FF589	Flakes-5g	600 packets/carton
FF449	Flakes-110ml/22g	60 bottles/carton



FF589

FF449

SUPER BABY

Nutritional fine feeds for all tropical baby fishes.

- All essential minerals and vitamins added for the crucial growing up stage of all baby fishes
- Specially grinded into fine bits for easy feeding and digestive
- Promote natural development of colour for the fishes
- Highly receptive by all fishes and high protein content
- Special immune substance added
- Will not cloud water

Code No.	Specification	Packing
FF654	Powder Form-10g	600 packets/carton
FF503	Powder Form-110ml/60g	60 bottles/carton



FF654

FF503

SUPER CRUSTANORISH

A superior sinking pellet for Hermit Crabs, Crayfishes, Lobsters, Crabs and all Crustaceans.

- Contain calcium elements and strengthening of shell
- Once well fed, it will prevent cannibalism or harming of other tankmates
- Promoting growth, vitality and health
- With super immune substance added
- Complete nutrition and color enhancing capability
- Multi-vitamin / mineral added



FF658

FF633

Code No.	Specification	Packing
FF633	Sinking Pellet-110ml/65g	60 bottles/carton
FF658	Sinking Pellet-280ml/165g	48 bottles/carton

SUPER BLOODWORM

Best quality fresh freeze dried jumbo sized bloodworms.

- Biggest and fat sized bloodworms in the market
- High protein and mineral encased
- Multi-vitamins added
- Anti-bacteria sterilized
- Will not cloud water



FF525

FF524

FF523

Code No.	Specification	Packing
FF523	100% BloodWorm-110ml/10g	60 bottles/carton
FF524	100% BloodWorm-280ml/20g	48 bottles/carton
FF525	100% BloodWorm-550ml/40g	24 bottles/carton

SUPER TUBIFEXWORM

Best quality clean freeze dried worms.

- Anti-bacteria treated
- Will not cloud water
- High protein and mineral encased
- Multi-vitamins added



FF528

FF527

FF526

FF660

Code No.	Specification	Packing
FF660	100% TubifexWorm-5g	360 packets/carton
FF526	100% TubifexWorm-110ml/13g	60 bottles/carton
FF527	100% TubifexWorm-280ml/30g	48 bottles/carton
FF528	100% TubifexWorm-550ml/70g	24 bottles/carton

SUPER BLOODPARROT

A superior granules feed for Blood Parrot cichlids.

- Great for colour development
- Nourishing feed to provide vigor and health
- Balance feed for growth and improving body shape
- Healthier and shiner scales after constant feed
- Special immune substance added
- Head growth development feed
- Excellent palatability and easy digestible
- Will not pollute water



FF509

FF508

FF653

Code No.	Specification	Packing
FF653	Floating Pellet-20g	360 packets/carton
FF508	Floating Pellet-280ml/120g	48 bottles/carton
FF509	Floating Pellet-550ml/270g	24 bottles/carton

XO XI TUAN YUAN

- Enhance Head-Growth
- Induce Sparkle Dot Contrast
- Intensify Redness
- Fin Growth

XO Xi Tuan Yuan is a superior quality nutritional feed specially formulated for the remarkable Xi Tuan Yuan fish. A complete and nutritious feed rich in vitamins and essential trace elements, it is also recommend for all Cichlids and Flowerhorn fish. Finest quality assured.



FF890

FF889

Code No.	Specification	Packing
FF889	Medium Pellet-280ml/100g	48 bottles/carton
FF890	Medium Pellet-1100ml/400g	12 bottles/carton

XO HUMPHY HEAD

- Ocean Free Humphy Head is a unique formulated fish feed to induce speedy head growth for all Flower Horn Breeds. Shape of head growth will also improve through constant feeding. Also feed with Ocean Free Starry and Ocean Free Ever Red for Flower Horn to get the best result
- Feed is high in protein so as to help fish grow at a faster rate and improving head growth
- High content of Spirulina and Krill extracts with other natural color enhancing elements that will improve the fish's sparkle dots in 2-3 weeks
- Special immune substance added to increase fish's resistance against diseases

Code No.	Specification	Packing
FF648	(ML) Pellet-25g	500 packets/carton
FF649	(M) Pellet-25g	500 packets/carton
FF478	(ML) Pellet-280ml/100g	48 bottles/carton
FF432	(M) Pellet-280ml/120g	48 bottles/carton
FF481	(ML) Pellet-1100ml/400g	12 bottles/carton



FF481(ML) FF478 (ML)/
FF432 (M) FF648 (ML)/
FF649 (M)

XO EVER RED

- Ocean Free Ever Red is an essential fish food to magnify the red coloration for all Flower Horn Breeds. Constant feeding will increase the spread of redness and maintaining the intensity throughout. Also feed with Ocean Free Starry and Ocean Free Humphy Head for Flower Horn to get the best result
- Feed is specially processed to help the fish grow at a more radiant and healthy fish
- High content of Spirulina and Krill exerts with other natural color enhancing elements that will improve the fish's redness in 2-3 weeks
- Special immune substance added to increase fish's resistance against diseases

Code No.	Specification	Packing
FF650	(ML) Pellet-25g	500 packets/carton
FF651	(M) Pellet-25g	500 packets/carton
FF477	(ML) Pellet-280ml/100g	48 bottles/carton
FF431	(M) Pellet-280ml/120g	48 bottles/carton
FF480	(ML) Pellet-1100ml/400g	12 bottles/carton



FF480(ML) FF477 (ML)/
FF431 (M) FF650 (ML)/
FF651 (M)

XO SUPER REDSYN

- Ocean Free XO Super Redsyn is the total special formulated fish feed that will induce speedy head growth for the new generation Redsyn Flower Horn Breeds. Shape of the head growth and redness will also improve through constant feeding
- Feed is high in protein so as to help fish grow at a faster rate and improving head growth
- High content of Spirulina and high-grade special color enhancement ingredients that will improve the fish's colors in 2-3 weeks period
- Special immune substance added to increase fish's resistance against diseases

Code No.	Specification	Packing
FF652	(M & ML) Pellet-25g	500 packets/carton
FF522	(M & ML) Pellet-280ml/120g	48 bottles/carton
FF541	(M & ML) Pellet-1100ml/400g	12 bottles/carton



FF541 FF522 FF652

XO STARRY

- Ocean Free Starry is a special formulated fish feed to speedily surface the sparkle dots for all Flower Horn Breeds. Constant feeding will not only enhance the number of the dots, but also enhance the shine. Also feed with Ocean Free Ever Red and Ocean Free Humphy Head for Flower Horn to get the best result
- Feed is specially processed to help the fish grow at a faster rate and improving health
- High content of Spirulina and Krill extract with other natural color enhancing elements that will improve the fish's sparkle dots in 2-3 weeks
- Special immune substance added to increase fish's resistance against diseases

Code No.	Specification	Packing
FF479	(ML) Pellet-280ml/100g	48 bottles/carton
FF433	(M) Pellet-280ml/120g	48 bottles/carton
FF482	(ML) Pellet-1100ml/400g	12 bottles/carton



FF482(ML) FF479 (ML)/
FF433 (M)

ROYAL RED

- Ocean Free "Royal Red" is specially formulated to enhance coloration and induce speedy growth for all tropical and cold-water freshwater fishes. Overall shape of the fish will also improve through constant feeding
- Special process of this food results in the maintenance of the nutritional contents; vitamins and enzyme, therefore helping your fish grow faster and healthier
- High content of Krill, Spirulina, Astaxanthin and other types of natural color enhancement elements. Color of fish will improve in 2 - 3 weeks period
- Special immune substance added to increase fish resistance against diseases



FF778 FF596 FF593 FF552



FF553 FF594 FF595 FF777

Code No.	Specification	Packing
FF593	Small Pellet-110g	50 bottles/carton
FF594	Mini Pellet-110g	50 bottles/carton
FF595	Mini Pellet-240g	48 bottles/carton
FF596	Small Pellet-270g	48 bottles/carton
FF777	Mini Pellet-600g	24 bottles/carton
FF778	Small Pellet-600g	24 bottles/carton
FF552	Small Pellet-1.2kg	12 bottles/carton
FF553	Mini Pellet-1.2kg	12 bottles/carton

XO JUMBO STICKS

Ocean Free XO Jumbo Sticks are specially formulated for the dietary needs for all turtles and water reptiles. Packed with essential vitamins and calcium to enhance proper growth, health, shell development and colour.

Ocean Free XO Jumbo Sticks are made to float and easily digestible even by the most demanding turtles / water reptiles. Does not cloud water and with special immune substance added.



PD353 PD355 PD354

Code No.	Specification	Packing
PD353	Jumbo Sticks-110ml/34g	60 bottles/carton
PD354	Jumbo Sticks-280ml/80g	48 bottles/carton
PD355	Jumbo Sticks-1100ml/280g	12 bottles/carton

OSCAR TURTLE FOOD NATURAL

- Special dried shrimps for turtle / terrapins
- Clean, nutritional and high in calcium



Code No.	Specification	Packing
PD029	Shrimp-29g	36 bottles/carton

KAGAYAKI HI-SPIRULINA

• Natural Colour Enhancer

• Improve Immune System

1. Kagayaki is a daily food supplement for your fish, and the special added ingredient will improve their colour
2. Kagayaki is floating food and will not cloud the water
3. All Kagayaki fish foods are manufactured by highly automated and specialized equipment, using selected ingredient developed through extensive research



FF684A FF684B

Code No.

FF684B
FF684A

Specification

Large Pellet-5kg
Large Pellet-10kg

Packing

4 packets/carton
Individual

KAGAYAKI HI-GROWTH

• Natural Growth Enhancer • Enrich with Vitamin E • Improve Immune System

1. Kagayaki is a daily food supplement for your fish, made from high quality wheat germ which promote natural growth and also improve the immune system for your fish
2. This is a floating type of feed that will not pollute the water
3. Only materials of the highest quality are mixed into the feed to promote healthy and beautiful growth of the Koi
4. The feed also incorporates ingredients that improve the appetite of the Koi
5. The feed is manufactured under strict production conditions to ensure superior quality and stability



FF684D FF684

Code No.

FF684D
FF684

Specification

Large Pellet-5kg
Large Pellet-10kg

Packing

4 packets/carton
Individual

XO TURTLE FOOD STICKS

Latest formula ensuring every requirement of reptile nutrition, fortified with vitamins & calcium. Promotes colour, health and growth. The food is designed to float, easy to digest and assimilate, also accepted willingly by all turtles. Does not cloud water.

Feed two or three times daily. Remove any excess left over food.



PD404 PD046 PD045 PD047 PD323

Code No.

PD404
PD045
PD046
PD047
PD323

Specification

Small Sticks-20g
Small Sticks-110ml/40g
Small Sticks-280ml/110g
Medium Sticks-550ml/200g
Medium Sticks-1100ml/400g

Packing

360 packets/carton
60 bottles/carton
48 bottles/carton
24 bottles/carton
12 bottles/carton

SUPER FISH STAPLE FOOD

• General staple flake food for all ornamental fishes

• Filled with essential vitamins, minerals and will not cloud water



FF054 FF052 FF053 FF055

Code No.

FF052
FF053
FF054
FF055
FF052A

Specification

Flakes-110ml/25g
Flakes-280ml/50g
Flakes-550ml/100g
Flakes-1100ml/200g
Flakes-1kg

Packing

60 bottles/carton
48 bottles/carton
24 bottles/carton
12 bottles/carton
5 packets/carton

TUBIFEX WORM

Best quality clean freeze dried worms.

- Anti-bacteria treated
- Will not cloud water
- High protein and mineral encased
- Multi-vitamins added

Code No.	Specification	Packing
FF072	100% Tubifex Worm-1kg	12 packets/carton



XO PREMIUM GOLD

Natural color enhancer feed that induces lion head growth, increase shine of scales and trim fish body shape. Suitable for all common to premium grade goldfish's use.

- Ocean Free XO Premium Gold is a feed derived under long lab research and with the consultation with top goldfish breeders. This is a premium multi-use feed that suit goldfishes of all grades and types. A must have break through feed for all goldfishes
- Feed contains high percentage of Krill, Carotene, Spirulina, Natural Color Enhancing Formula to bring out intense redness and scale shine. Special fish protein added to induce lion head growth. High-grade wheat germ also included to increase fibre to assist in digestion to attain good body shape growth
- Special Immune Substance, multi vitamins, minerals and trace elements are added in order to build up body resistance and reduce chances of contracting diseases. Feed is fortified with beneficial bacterial in order not to alter water quality

Code No.	Specification	Packing
FF546	Floating Pellet-280ml/130g	48 bottles/carton
FF547	Sinking Pellet-280ml/180g	48 bottles/carton



FF547 (Sinking)

FF546 (Floating)

XO KING SHRIMP

Ocean Free XO King Shrimp is specially processed to keep in the best taste and flavor for fishes dietary consumption. Definite to induce fish's appetite even for the most picky eaters and it is 100% bacteria and parasite free. It is high in protein, natural fat, astaxathin content and with multi-vitamins added. Assist in increasing of immune system of fish and at the same time the color enhancing property will intensify overall coloration. Suitable for Arowana, Luo Han family, Cichlid, Koi, Marine fish and Crustaceans (lobsters/crabs).

Code No.	Specification	Packing
FF462	Shrimp-550ml/55g	24 bottles/carton
FF463	Shrimp-1100ml/110g	12 bottles/carton



FF462

FF463

XO SUPER COLOUR ENHANCER

- "XO Super Colour Enhancer" is special formulated to enhance the colour of most fishes to its best natural colouration. Especially Red
- It underwent special process, contains high protein, multi-vitamins, enriched ingredients, minerals and enzymes. Therefore helping your fish to grow faster and healthier
- High contents of Krill, Spirulina, Astaxanthin and other type of natural colour enhancing elements. Colour of fishes will improve within 2-4 weeks
- Special immune substance added to increase fish resistance against diseases

Code No.	Specification	Packing
FF394	Micro Bits-110ml/60g	60 bottles/carton
FF602	Micro Bits-280ml/135g	48 bottles/carton



FF602

FF394

XO KOI FOOD SERIES

- Customized KOI food for different feeding needs
- Catered for growth, digestive, color enhancement and body shape development
- Essential vitamins and minerals to provide best possible balanced diet
- Beneficial for indoor and outdoor use



1kg & 5kg Size Available

Code No.	Description	Specification	Packing
FF318	XO Superior Colour-Excel (L)	Floating Pellet-1kg	20 packets/carton
FF319	XO Superior Colour-Excel (M)	Floating Pellet-1kg	24 packets/carton
FF536	XO Superior Colour-Excel (M)	Floating Pellet-5kg	4 packets/carton
FF539	XO Superior Colour-Excel (L)	Floating Pellet-5kg	4 packets/carton
FF314	XO Wheat Germ-Growth (L)	Floating Pellet-1kg	20 packets/carton
FF315	XO Wheat Germ-Growth (M)	Floating Pellet-1kg	24 packets/carton
FF788	XO Wheat Germ-Growth (M)	Floating Pellet-5kg	4 packets/carton
FF483	XO Wheat Germ-Growth (L)	Floating Pellet-5kg	4 packets/carton
FF579	XO Premium Wheat Germ (M)	Floating Pellet-1kg	24 packets/carton
FF580	XO Premium Wheat Germ (L)	Floating Pellet-1kg	20 packets/carton
FF792	XO Premium Wheat Germ (M)	Floating Pellet-5kg	4 packets/carton
FF581	XO Premium Wheat Germ (L)	Floating Pellet-5kg	4 packets/carton
FF316	XO Spirulina & Wheat Germ (L)	Floating Pellet-1kg	20 packets/carton
FF317	XO Spirulina & Wheat Germ (M)	Floating Pellet-1kg	24 packets/carton
FF790	XO Spirulina & Wheat Germ (M)	Floating Pellet-5kg	4 packets/carton
FF535	XO Spirulina & Wheat Germ (L)	Floating Pellet-5kg	4 packets/carton

CONFIRM RED

- Ocean Free Confirm Red is an advanced formulated fish feed mainly for color enhancement and the induction of faster growth for all tropical and cold water freshwater fishes. With constant feeding, fish's shape will also improve.
- Strict and special processing of this feed results in the maintenance of all the nutritional contents; vitamins and enzyme, therefore assisting faster growth and better health condition.
- High content of Krill, Spirulina, Astaxanthin and other natural color enhancement elements. With constant feeding, improvement of fish's color can be seen in 2-3 weeks period.
- Special immune substance added to increase fish's resistance against diseases.



Code No.	Specification	Packing
FF692	Baby Pellet-600g	24 bottles/carton
FF694	Baby Pellet-1.2kg	12 bottles/carton
FF693	Mini Pellet-600g	24 bottles/carton
FF695	Mini Pellet-1.2kg	12 bottles/carton



MIRACLE RED

1. The product specifically targets on medium-sized to large-sized omnivorous fishes or Cichlid. Size of feed comes in medium or small grains giving easy intake for the fishes. It is also suitable for other fancy tropical fishes.
2. No chemicals such as artificial pigments or growth hormones added, allowing fishes to grow as natural as possible. Containing polysaccharid immune substances to strengthen immune system hence assuring good health for the fishes. There are also unsaturated fatty acid Ω 3, 6, 7, 9 to facilitate metabolism and enhancing assimilation. High level of fish protein and special digestion enzyme for better assimilation, digestion and growth of the fish. It also maintains body shape and reducing water pollution possibilities.
3. Added krill powder, spirulina and special natural color enhancing substances to provide necessary nutrition for fish growth and to develop their natural color. Different types of microelements, minerals are present to prevent any physical malfunctions due to nutritional imbalance.
4. Contain antioxidant substances.



Code No.	Specification	Packing
YHMR01	Micro Pellet-57g	48 bottles/carton
YHMR02	Small Pellet-150g	48 bottles/carton
YHMR03	Mini Pellet-240g	48 bottles/carton
YHMR04	Mini Pellet-940g	12 bottles/carton

Premium Decap Artemia Eggs

OF® Decap Artemia Eggs are from non-polluting environment and are not hatched during the dormant period. These eggs are treated carefully with high technology during the process of decap, leaving a thin layer to surround the bright orange embryos, retaining the original high protein and others various of amino acids that can be absorb by newly hatched fish and shrimp. It's a rare feed that are hard to come by, a perfect feed for fry / juvenile fish and shrimp.

Feature of OF® Decap Artemia Eggs:

1. Easy to transport and store. Store at normal cool room temperature.
2. Using high technology to decap, ensure nutrition is perfectly preserved, safe and reliable to use.
3. The Decap Artemia Eggs is produce by OF® which contain various of nutritional value that are better compare to hatched juvenile shrimp as it saves the energy consumed by the larvae.
4. The protein, amino acids and various important enzymes of the Decap Artemia Eggs by OF® are preserved intact and its nutrition meets the needs for the growth of fry / juvenile fish and shrimp.
5. Suitable for fresh / marine fish and shrimp.



FF1059

FF1244

Code No.

FF1059
FF1244

Specification

425g
40g

Packing

24 bottles/carton
60 bottles/carton

BRINE SHRIMP EGGS

- Ocean Free Super Brine Shrimp Eggs is the best selected premium grade in the market
- High hatching rate, constant brine shrimps size, easy to hatch, longer life etc



FF060

FF059

Code No.

FF059
FF060

Specification

Eggs-9g
Eggs-26g

Packing

48 bottles/carton
48 bottles/carton

SUPER HOLIDAY / WEEKEND FOOD BLOCK

For Tropical & Goldfish

- Contains Freeze Dried Tubifex, Brine Shrimp, Daphnia, Mosquito Larvae
- Cleans & Neutralizes Water For a Period up to 10 Days



FF892



FF891

Code No.

FF891
FF892

Specification

Small Clamshells
Large Clamshell

Packing

288 packets/carton
288 packets/carton

SAIKOH & SAIKOH G2 FISH FOOD

- Special Fish Food
- Floating Type
- Special Colour Enhancer added



220g

500g

Code No.	Specification	Packing
FF661	G2 Baby Pellet-Green-100g	60 packets/carton
FF662	G2 Baby Pellet-Red-100g	60 packets/carton
FF663	G2 Baby Pellet-Mix-100g	60 packets/carton
FF667	Baby Pellet-Green-220g	48 packets/carton
FF668	Baby Pellet-Red-220g	48 packets/carton
FF669	Baby Pellet-Mix-220g	48 packets/carton
FF673	Baby Pellet-Green-500g	24 packets/carton
FF674	Baby Pellet-Red-500g	24 packets/carton
FF675	Baby Pellet-Mix-500g	24 packets/carton
FF768	G2 Baby Pellet-Green-1kg	24 packets/carton
FF769	G2 Baby Pellet-Red-1kg	24 packets/carton
FF770	G2 Baby Pellet-Mix-1kg	24 packets/carton
FF880	G2 Baby Pellet-Green-5kg	4 packets/carton
FF881	G2 Baby Pellet-Red-5kg	4 packets/carton
FF882	G2 Baby Pellet-Mix-5kg	4 packets/carton



1kg

5kg

100g

Code No.	Specification	Packing
FF664	G2 Mini Pellet-Green-100g	60 packets/carton
FF665	G2 Mini Pellet-Red-100g	60 packets/carton
FF666	G2 Mini Pellet-Mix-100g	60 packets/carton
FF670	Mini Pellet-Green-220g	48 packets/carton
FF671	Mini Pellet-Red-220g	48 packets/carton
FF672	Mini Pellet-Mix-220g	48 packets/carton
FF676	Mini Pellet-Green-500g	24 packets/carton
FF677	Mini Pellet-Red-500g	24 packets/carton
FF678	Mini Pellet-Mix-500g	24 packets/carton
FF771	G2 Mini Pellet-Green-1kg	24 packets/carton
FF772	G2 Mini Pellet-Red-1kg	24 packets/carton
FF773	G2 Mini Pellet-Mix-1kg	24 packets/carton
FF883	G2 Mini Pellet-Green-5kg	4 packets/carton
FF884	G2 Mini Pellet-Red-5kg	4 packets/carton
FF885	G2 Mini Pellet-Mix-5kg	4 packets/carton



Baby Green



Baby Red

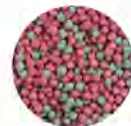

Baby Mix



Mini Green



Mini Red



Mini Mix

Code No.	Specification	Packing
FF679	Large Pellet-Green-500g	24 packets/carton
FF680	Large Pellet-Red-500g	24 packets/carton
FF681	Large Pellet-Mix-500g	24 packets/carton
FF774	G2 Large Pellet-Green-1kg	20 packets/carton
FF775	G2 Large Pellet-Red-1kg	20 packets/carton
FF776	G2 Large Pellet-Mix-1kg	20 packets/carton
FF886	G2 Large Pellet-Green-5kg	4 packets/carton
FF887	G2 Large Pellet-Red-5kg	4 packets/carton
FF888	G2 Large Pellet-Mix-5kg	4 packets/carton



Large Green



Large Red



Large Mix

FANCY TURTLE STICKS

Classica Fancy Turtle Sticks is specially made and formulated to provide every need for good health of aquatic reptile / amphibian pets. It contains all necessary vital vitamins and minerals for good growth and shell formation. This feed is made to float on water, easily digestible and palatable by all turtle type. This feed will not cloud water.



Code No.	Specification	Packing
PD443	Floating Stick (S)-30g	360 packets/carton
PD444	Floating Stick (S)-90g	96 packets/carton
PD417	Floating Stick (S)-110ml/45g	60 bottles/carton
PD414	Floating Stick (S)-280ml/115g	48 bottles/carton
PD415	Floating Stick (M)-550ml/210g	24 bottles/carton
PD416	Floating Stick (M)-1100ml/420g	12 bottles/carton

DAILY FLAKE

- General staple flake food for all ornamental fishes
- Filled with essential vitamins, minerals and will not cloud water



Code No.	Specification	Packing
FF686	Flakes-110ml/25g	60 bottles/carton
FF687	Flakes-280ml/50g	48 bottles/carton
FF688	Flakes-550ml/100g	24 bottles/carton
FF767	Flakes-1100ml/200g	12 bottles/carton

HEAD CHAMP

- High Protein Formula for Head Growth
- Enriched with Multi-Vitamins for MAX ENERGY

Classica Head Champ is a superior quality nutritional feed formulated for Flowerhorn Fishes.

- Enriched with Multi-Vitamins, Calcium, Trace Elements & Minerals for MAX ENERGY and GROWTH
- Special Formula to INCREASE Flowerhorn's Hump Size
- Will not cloud water



Code No.	Specification	Packing
FF860	Pellet-110g	84 packets/carton
FF861	Pellet-550g	15 packets/carton



FF861

FF860

RED CHAMP

- Color Enhancing Formula for Intense Color
- Enriched with Multi-Vitamins for MAX ENERGY

Classica Red Champ is a superior quality colour enhancing formula for Flowerhorn Fishes.

- Enriched with Multi-Vitamins, Calcium, Trace Elements & Minerals for MAX ENERGY and GROWTH
- Special Formula to INTENSIFY Flowerhorn's colour
- Will not cloud water



Code No.	Specification	Packing
FF858	Pellet-110g	84 packets/carton
FF859	Pellet-550g	15 packets/carton



FF859

FF858

SPIRU-MAX POWDER

- Quality Supplement made of the Freshest Ingredients
- Intensify your Fishes' Natural Colour
- Maximize your Fishes' Growth Rate

Ocean Free Spiru-Max Powder is a quality dietary supplement specially formulated for all aquatic species and made using the freshest ingredients harvested from non-polluted sources. Spiru-Max Powder helps you to achieve comprehensive nourishment and accelerated growth rate for your fish in the most natural way possible. It contains Spirulina, one of nature's richest sources of protein, minerals, and amino acids. Spiru-Max also contains natural pigments which excel in enhancing and intensifying your fish's colouration.

Code No.	Specification	Packing
FF865	Powder-50g	36 bottles/carton
FF866	Powder-550g	12 cans/carton



FF866

FF865

AROWANA TANK SYSTEM MK IIIS

The best just got better!

We are constantly challenging ourselves to create the ultimate conditions for your Arowana; from the construction details, lighting, water circulation, and right down to the mechanical and biological filtration, no detail is too small in our single obsession to help your Arowana achieve its full potential.



Hydro - Pure Technology



3DM Filter Medium



Micron Mesh Bag



Bidirectional Flow

Tank size - 155 x 68 x 167cm

Tank size - 176 x 68 x 167cm

Tank size - 218 x 68 x 167cm

Code No.	Colour (Panel / Trimming / Background)	Code No.	Colour (Panel / Trimming / Background)	Code No.	Colour (Panel / Trimming / Background)
AT791	Black / Black / Black	AT797	Black / Black / Black	AT803	Black / Black / Black
AT792	Black / Black / White	AT798	Black / Black / White	AT804	Black / Black / White
AT793	Black / Gold / Black	AT799	Black / Gold / Black	AT805	Black / Gold / Black
AT794	Black / Gold / White	AT800	Black / Gold / White	AT806	Black / Gold / White
AT795	White / Gold / Black	AT801	White / Gold / Black	AT807	White / Gold / Black
AT796	White / Gold / White	AT802	White / Gold / White	AT808	White / Gold / White

AROWANA TANK SYSTEM MK IIIS

Product Features

- **Stable Water Parameters.** Equipped with Hydra Depurator which uses the revolutionary Hydro-Pure Technology to effectively detoxify Ammonia and Nitrite, creating safe and stable pristine "Hydro-Pure Water".
- **Trickling-Filter Biological Filtration.** A trickling-filter using 3DM filter medium creates an optimum oxygen rich environment for aerobic bacteria.
- **3DM Biological Media.** Contains the ultra-high surface area 3DM filter medium that promotes faster biological breakdown of harmful toxins like Ammonia, Nitrite for cleaner water and healthier Arowana.
- **Effective Mechanical Filtration.** Uses 100-micron Nylon filter socks that helps remove fine particulates from your water, greatly enhancing water clarity. It is easy to clean and reusable; arguably the best form of mechanical filtration.
- **Brilliant LED Illumination.** Energy saving LED lighting system that uses the propriety OF X-LEDs; greatly enhances coloration of your Arowana.
- **Smart Controls.** Powered by microcontroller that allows user to control lighting, ambience lighting, ventilation, etc.
- **Auto Water Top-Off.** Water storage compartment that automatically top-ups water level for 7-14 days, eliminating issues caused by evaporation.
- **OF® Biomagnetic Technology.** Creates Arowana's natural magnetic field in its habitat, allowing healthier Arowana growth.
- **Enhanced Water Circulation.** Efficient overflow and return system design boosts water circulation and eliminates dead spots in the display tank.
- **Crystal Clear Glass.** Displays your Arowana in an exceptionally high clarity and in their most natural and vivid colours
- **Energy Saving.** Powered by two inverter technology pumps that deliver high water volume using lesser energy; and safety in the event that one of the pumps fail.
- **Touch Control.** Advanced touch-sensor panel empowers you with easy control of your aquarium equipment.

Specification	155	176	218
Overall Dimension - L x W x H	1550 x 680 x 1670 mm	1760 x 680 x 1670 mm	2180 x 680 x 1670 mm
Colour - Panel Colour	White or Black	White or Black	White or Black
Colour - Side Trimmings	Gold or Black	Gold or Black	Gold or Black
Tank Dimension - L x W x H	1550 x 680 x 910mm	1760 x 680 x 910mm	2180 x 680 x 910mm
Cabinet Dimension - L x W x H	1550 x 680 x 760mm	1760 x 680 x 760mm	2180 x 680 x 760mm
Glass Thickness	12mm	12mm	15mm
Glass Material	<ul style="list-style-type: none"> • Tank (Black Background): Front Panel in Crystal Glass, and 4 sides Normal Glass. • Tank (White Background): Front Panel and Bottom Panel in Crystal Glass, and 3 sides Normal Glass. 		
Total Volume	822L	954L	1184L
Display Tank Volume	630L	750L	940L
Sump Tank Volume	192L	204L	244L
Sump Tank Dimension - L x W x H	1032 x 495 x 400mm	1212 x 495 x 400mm	1473 x 495 x 400mm
Sump to Tank Volume Ratio	30.4%	27.2%	26%
White Filter Wool - L x W x H	(268 x 156 x 30mm) x 10pcs	(268 x 156 x 30mm) x 14pcs	(268 x 156 x 30mm) x 18pcs
Bio Foam - L x W x H	(428 x 200 x 60mm) x 4pcs	(428 x 200 x 60mm) x 4pcs	(428 x 200 x 60mm) x 4pcs
Filter Socks (Micron x Qty x Length)	100 x 3 x 100	100 x 3 x 100	100 x 3 x 100
Biological Filtration - 3DM Filter Medium (L)	21L	21L	41L
LED Lighting (RGB)	30.2W x 4	38.6W x 4	41W x 4
Lighting (Front)	11.8W	15.2W	18.5W
Water Pump (with Inverter Technology)	6500L/H x 2 50W x 2 pcs	8000L/H x 2 75W x 2 pcs	10000L/H x 2 85W x 2 pcs
Hydra Filtration	Hydra Stream 1	Hydra Stream 2	Hydra Stream 3
Packaging Tank Dimension - L x W x H	1630 x 752 x 1100mm	1840 x 752 x 1100mm	2260 x 752 x 1100mm
Packaging Cabinet Dimension - L x W x H	1630 x 752 x 924mm	1840 x 752 x 924mm	2260 x 752 x 924mm
Weight - Tank	Net Wt. 235KG, Gross Wt. 300KG	Net Wt. 240KG, Gross Wt. 314KG	Net Wt. 300KG, Gross Wt. 388KG
Weight - Cabinet	Net Wt. 142KG, Gross Wt. 202KG	Net Wt. 162KG, Gross Wt. 233KG	Net Wt. 194KG, Gross Wt. 280KG

NT TANK SERIES II

- Raceway Filtration Sump Tank (Optional) - Compact design, allowing better mixing of water. Encourage beneficial bacteria growth.
- Touch Screen Control Panel (Optional).
- Panoramic View - No dead zones for better viewing pleasure. Concealed filtration inlets and outlets.
- T5 Lightings - Full spectrum lightings for your precious fish.
- Aluminum Framed Cabinet - Durable and strong. Water resistant.
- Design compatible with Sump Tank filter / Canister filter / Internal filter.
- Corner surface skimmer overflow.
- Smart Packing Design - Sub-assembled cabinet packed together with main tank and sump tank in one wooden box.
- Suitable for all Monster tropical fishes, Arowanas, Blood parrots...etc.



Code No.

Description

AT743	NT350T-M II (1230 x 610 x 1670MM) TANK W.CABINET/SUMP -TITANIUM
AT743M	NT350T-M II (1230 x 610 x 1670MM) TANK W.CABINET/FTL MED -TITANIUM
AT745	NT500T-M II (1500 x 610 x 1670MM) TANK W.CABINET/SUMP -TITANIUM
AT745M	NT500T-M II (1500 x 610 x 1670MM) TANK W.CABINET/FTL MED -TITANIUM
AT747	NT600T-M II (1790 x 610 x 1670MM) TANK W.CABINET/SUMP -TITANIUM
AT747M	NT600T-M II (1790 x 610 x 1670MM) TANK W.CABINET/FTL MED -TITANIUM

Specification	NT350	NT500	NT600
Overall Dimension - L x W x H	1230 x 610 x 1670 mm	1500 x 610 x 1670 mm	1790 x 610 x 1670 mm
Tank Dimension - L x W x H	1230 x 610 x 800 mm	1500 x 610 x 800 mm	1790 x 610 x 800 mm
Cabinet Dimension - L x W x H	1200 x 610 x 770 mm	1470 x 610 x 770 mm	1760 x 610 x 770 mm
Sump Dimension - L x W x H	840 x 440 x 420 mm	1200 x 400 x 420 mm	1200 x 400 x 420 mm
Glass Thickness	10mm	12mm	12mm
Glass Material	Crystal Clear Glass (Front Only)	Crystal Clear Glass (Front Only)	Crystal Clear Glass (Front Only)
Total Volume	490L	705L	835L
Tank Volume	390L	560L	690L
Sump Volume	100L	145L	145L
LED Lighting (RGB)	2 x 22.5W	2 x 31.5W	2 x 39W
Water Pump	Amphi 3500	Amphi 5000	Amphi 6500
Hydra Stream Depurator	Hydra Stream 1	Hydra Stream 2	Hydra Stream 3
Biological Filtration - Bio Ball	4L	4L	4L
Biological Filtration - 3DM Filter Medium	20L	40L	40L
Packaging Dimension - L x W x H	Tank: 1300 x 680 x 980mm	Tank: 1570 x 680 x 980mm	Tank: 1860 x 680 x 980mm
Weight	Gross Weight: 240kg; Net Weight: 170kg	Gross Weight: 330kg; Net Weight: 250kg	Gross Weight: 400kg; Net Weight: 315kg
Colour	Titanium Matt	Titanium Matt	Titanium Matt
Available Tank Background Colours	Blue / Black / White	Blue / Black / White	Blue / Black / White

Cabinet and Tank are packaged into one single box.
Great savings on transportation cost.

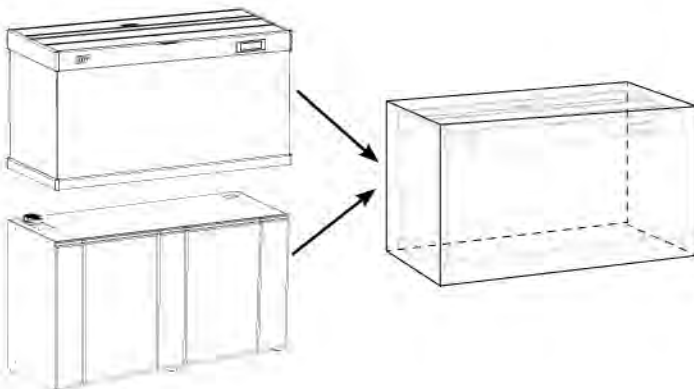

Raceway Filtration Sump Design.
Provides Better Water Mixing,
Encourage Beneficial Bacteria Growth.

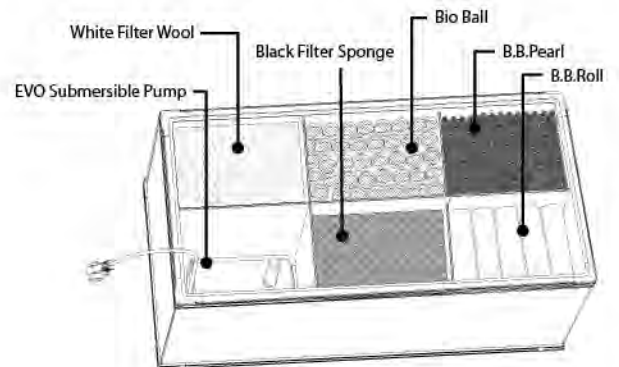

Glass Tank Series

- Uniquely designed tanks made with high quality resin glass.
- High production control and resistant to breakage.
- High class design style in various shape and sizes.



Code	Dimension (LxWxH)	Glass Thickness	Packing
AT956	15 x 15 x 15cm - without frame	5mm	Individual
AT957	15 x 15 x 20cm - without frame	5mm	Individual
AT958	15 x 12 x 15cm - without frame	5mm	Individual
AT959	12 x 12 x 15cm - without frame	5mm	Individual
AT960	15 x 15 x 20cm - black frame	5mm	Individual
AT961	15 x 15 x 20cm - white frame	5mm	Individual
AT962	19.5 x 19.5 x 23cm - black frame	5mm	Individual
AT963	19.5 x 19.5 x 23cm - white frame	5mm	Individual
AT966	30 x 16 x 24cm - black frame	5mm	Individual
AT967	30 x 16 x 24cm - white frame	5mm	Individual
AT968	36 x 22 x 27cm - black frame	5mm	Individual
AT969	36 x 22 x 27cm - white frame	5mm	Individual
AT970	25 x 25 x 25cm - black frame	5mm	Individual
AT971	25 x 25 x 25cm - white frame	5mm	Individual
AT972	30 x 30 x 30cm - black frame	5mm	Individual
AT973	30 x 30 x 30cm - white frame	5mm	Individual
AT974	45 x 45 x 36cm - black frame	5mm	Individual
AT975	45 x 45 x 36cm - white frame	5mm	Individual

CURVO TANK

- Hang-on Filter included for happier and healthier fishes!
- Energy saving LED Light with day and night mode.
- Comes with removable cover and feeding flap
- Ideal for homes & offices.

* Suitable for most small tropical fishes and shrimps.

Note: Images are for illustration purposes only. Gravel, ornaments, decorations and fishes not included.



OF® CURVO's colourful and exciting design will instantly brighten up any home or office space. This stylish aquarium is made with clear plastic which is light weight, durable and safe for everyone. It includes an eco-friendly LED Light that provides natural and soothing lighting in both day and night mode for your fishes as well as a compact and efficient Hang-on Filter that helps to maintain a healthy aquarium.

Discover a world of fun under the curves!



Hang-on Filter Included

Energy saving LED Light with day and night mode



Removable Cover and Feeding Flap



Total Power Consumption (W)	Filter Power Consumption (W)	Filter Flowrate (L/H)	LED Power Consumption (W)	LED Bulb Specification (Colour, Wattage and Qty)
5.66W	3.5W	120-150 L/H (adjustable)	2.16W	0.24W x 9pcs ("Ø"LED)

Code No.	Dimension(LxWxH)	Volume	Packing
AT696	25.5 x 25.5 x 27cm-Clear	12 Litre	8 pieces/carton
AT697	25.5 x 25.5 x 27cm-Blue	12 Litre	8 pieces/carton
AT698	25.5 x 25.5 x 27cm-Pink	12 Litre	8 pieces/carton

NANO SPACE

- Dual colour mode LED lamp - 12V (Daylight & Moonlight mode)
- Suitable for freshwater & marine setup
- Smart back filter system
- Durable glass with increased scratch resistance
- Low energy consumption
- Extra bright compact LED creates stunning Ripple Effect



RP200B **RP200A**
48 pieces/carton

Cartridge B
4. Bio Wool
5. Activated Carbon
6. Fine Bio Foam

Cartridge A
1. Coarse Bio Foam
2. Fine Bio Foam
3. Ceramic Ring

* Suitable for Nano Space, Nano Marine and Nano Planted Tank

Code No	Description	Dimension (LxWxH)	Volume	No of LED	Flowrate of the Pump	Total Power Consumption	Packing
AT533A	Nano Space-1	24 x 24 x 28cm	16 Litre	15 (3.6W)	300 L/H	7.6W	Individual
AT534A	Nano Space-2	27.5 x 27.5 x 32cm	24 Litre	20 (4.8W)	300 L/H	8.8W	Individual
AT535A	Nano Space-3	31 x 31 x 36cm	34 Litre	22 (5.28W)	480 L/H	11.28W	Individual
RP200A	Cartridge A	-	-	-	-	-	48 pieces/carton
RP200B	Cartridge B	-	-	-	-	-	48 pieces/carton

NANO PLANTED

- Specially for planted tanks and freshwater aquarium setup
- Durable glass with increased scratch resistance
- Low energy consumption
- Smart back filter system
- Super bright LED Clamping Lamp (Freshwater) for stunning ripple effects and provide optimum plant growth and promotes photosynthesis
- Featuring new OF'®' LED that provides superior full colour spectrum rendering
- Dual light mode with individual control switch allows you to recreate the daytime and moonlight conditions of nature

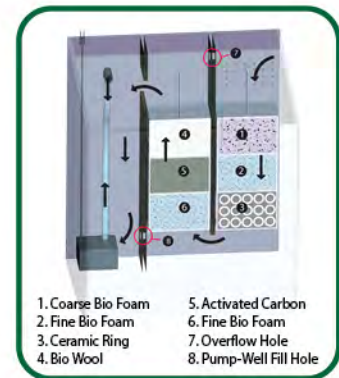
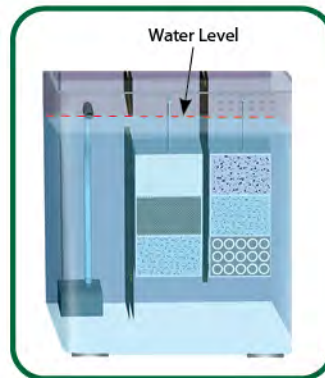

Iconic Compact
LED Lamp



Top View



Elegant Raised Base



Removable Filter
Cartridge for easy
maintenance



Ripple Effect

Code No	Description	Dimension (LxWxH)	Volume	No of LED	Flowrate of the Pump	Total Power Consumption	Packing
AT563A	Nano Planted-1	24 x 24 x 28cm	16 Litre	8 (9.48W)	300 L/H	13.48W	Individual
AT564A	Nano Planted-2	27.5 x 27.5 x 32cm	24 Litre	10 (12.48W)	300 L/H	15.48W	Individual
AT565A	Nano Planted-3	31 x 31 x 36cm	34 Litre	13 (15.72W)	480 L/H	21.72W	Individual

NANO MARINE

- Removable mini-protein skimmer for superior water quality
- Specially for marine setup
- Durable glass with increased scratch resistance
- Low energy consumption
- Smart back filter system
- Super bright LED Clamping Lamp (Marine) for stunning ripple effects
- Featuring new OF'@'' LED that provides superior full colour spectrum rendering
- Recreates the daytime and moonlight conditions of nature

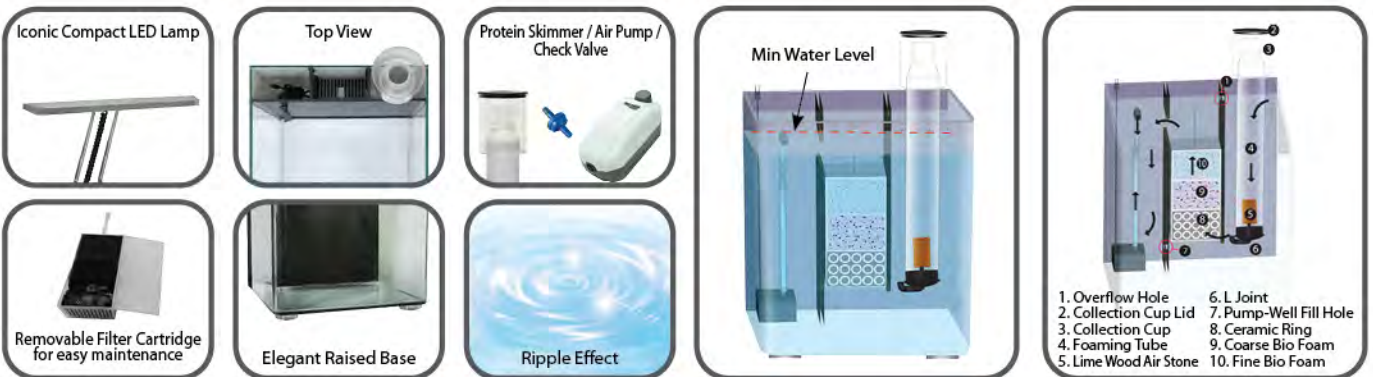

Code No	Description	Dimension (LxWxH)	Volume	No of LED	Flowrate of the Pump	Total Power Consumption	Packing
AT560A	Nano Marine-1	24 x 24 x 28cm	16 Litre	9 (9.72W)	300 L/H	17.02W	Individual
AT561A	Nano Marine-2	27.5 x 27.5 x 32cm	24 Litre	14 (13.44W)	300 L/H	20.74W	Individual
AT562A	Nano Marine-3	31 x 31 x 36cm	34 Litre	16 (16.44W)	480 L/H	25.74W	Individual



NANO MARINE 4 & 5

- Specially for Marine setup
- Removable Nano-protein skimmer for superior water quality
- Smart back-filter system features a specially designed surface skimmer to remove organic surface film to improve oxygen exchange and light penetration
- Removable filter medium cartridges in back-filter for ease of maintenance
 - Durable glass with increased scratch resistance
 - Extendable LED Lamp (Marine) for stunning ripple effects
- Featuring new OF 'X' LED that provides superior full colour spectrum rendering
- Dual light modes that recreate the daytime and moonlight conditions of nature
- Low energy consumption



NANO XL FILTER CARTRIDGE

RP246A: Cartridge A
1. Coarse Bio Foam
2. Activated Carbon

RP246B: Cartridge B
1. Coarse Bio Foam
2. Ceramic Ring

RP246C: Cartridge C
1. Bio Wool
2. Ceramic Ring

24 pieces/carton

* Suitable for Nano Marine 4 & 5



NANO MARINE 4

NANO MARINE 5

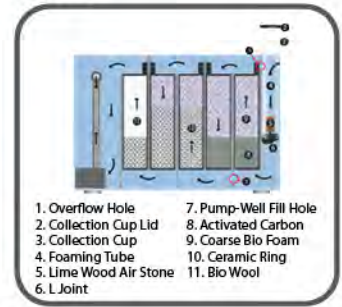
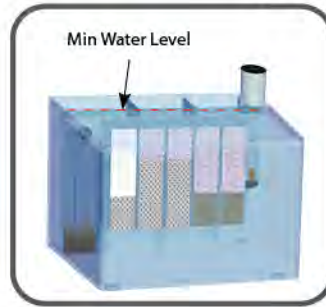
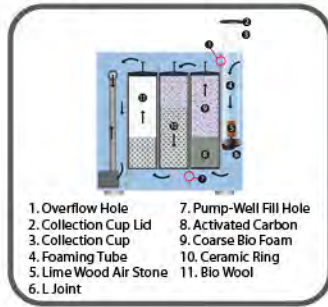
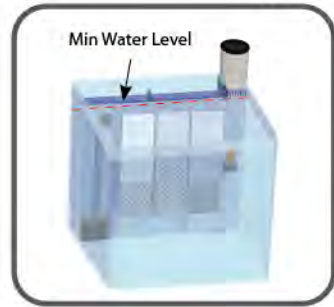

Code No	Description	Dimension (LxWxH)	Volume	Specification Watt (Actinic Blue+12K+'X' LED+14K)	Flowrate of the Pump	Total Power Consumption	Packing
AT640A	Nano Marine-4	44 x 36 x 40cm	63 Litre	26.16W (0.24W x 9 + 1.5W x 4 + 1.5W x 4 + 3W x 4)	520 L/H	37.46W	Individual
AT641A	Nano Marine-5	60 x 40 x 40cm	96 Litre	36.60W (0.24W x 15 + 1.5W x 4 + 1.5W x 6 + 3W x 6)	1300 L/H	64.90W	Individual

Code No.	Description	Specification	Packing
RP246A	Nano XL Filter Cartridge-A	Coarse Bio Foam / Activated Carbon	24 pieces/carton
RP246B	Nano XL Filter Cartridge-B	Coarse Bio Foam / Ceramic Ring	24 pieces/carton
RP246C	Nano XL Filter Cartridge-C	Bio Wool / Ceramic Ring	24 pieces/carton

BETTA FLORA TANK

- Smart hybrid tank system incorporating hydroponics in an aquarium.
- Easy one-step water change using simple overflow concept.
- Utilizes your fish's nutrient-rich waste for plant nourishment!
- Catchment cup allows easy disposal of excess waste water.
- Divider Plate allows you to hold two Bettas in one tank for mating purpose.
- Plastic Pebble Stones included.
- Built-in LED lamp in tank cover.

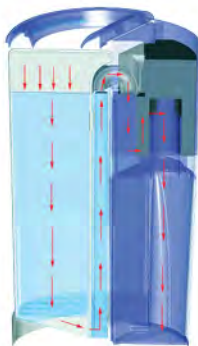

Product Components:

1. Main Tank Body
2. Overflow Tube
3. Tank Divider Plate (for mating purpose)
4. Tank Cover (with LED light)
5. Tank Bottom Plate
6. Hydroponics Sponge
7. Hydroponics Pot
8. Overflow Catchment Cup
9. 300ml Measuring Cup (not in illustration)
10. 88g Plastic Pebbles (not in illustration)

* Options for your own customized colours area available. 500pcs MOQ each colour.

Code No.	Dimension(LxWxH)	Volume	Packing
AT620A	15 x 15 x 25cm-White	2 Litre	12 pieces/carton
AT620B	15 x 15 x 25cm-Black	2 Litre	12 pieces/carton
AT620C	15 x 15 x 25cm-Blue	2 Litre	12 pieces/carton

BETTA SPACE TANK

The BettaSpace's design is a celebration of minimalism and innovation. The timeless minimalistic design makes it a pleasing decorative piece in any homes and offices. BettaSpace's high quality frames and durable high clarity glass tank creates an ideal habitat for Betta and other small fishes, shrimps and crustaceans. For the first time ever, the clever switchable Dual-View-LED lamp design allows you to create different lighting and visual impact as you please. To achieve even better illumination, 4 units of LEDs are placed around the LED lamp frame and angled at 35 degrees.

BettaSpace, where nature, art and innovation comes together.



* Plastic Plant and Plastic Pebbles included



Top View



Switchable Dual-View-LED lamp can fitted at the top or bottom of the tank according to your preference.



Bottom View

LED Lamp



* Options for your own customized colours area available. 500pcs MOQ each colour.

Code No.	Description	Dimension(LxWxH)	Volume	Packing
AT619A	Betta Space-Black	15.5 x 15.5 x 20.5cm	4.95 Litre/1.3 Gallon	4 pieces/carton
AT619B	Betta Space-White	15.5 x 15.5 x 20.5cm	4.95 Litre/1.3 Gallon	4 pieces/carton
AL397	Betta Space LED Lamp	---	---	24 pieces/carton

HATCHERY

Multiple Functions

FEATURES

- Hatchery for Live-bearers
- Holding & Separating Fishes
- Displaying Betta
- Separation by Species



AT330



AT1398

Code No	Description	Specification	Packing
AT330	Hatchery S	125 x 70 x 70mm	100 pieces/carton
AT1398	Hatchery M	208 x 97 x 100mm	60 pieces/carton

BETTA CUBE

- Various fun & exciting colors.
- Designed for retailers and hobbyist.
- Stackable to maximize space utilization.
- Studs allow ventilation even when stacked.
- Specially designed cover for quick maintenance.



Code No.	Dimension (LxWxH)	Packing
PT076A	8.1 x 8.1 x 7.2cm-Crystal Clear	48 pieces/carton
PT076B	8.1 x 8.1 x 7.2cm-Crystal Yellow	48 pieces/carton
PT076C	8.1 x 8.1 x 7.2cm-Crystal Green	48 pieces/carton
PT076D	8.1 x 8.1 x 7.2cm-Crystal Blue	48 pieces/carton
PT076E	8.1 x 8.1 x 7.2cm-Crystal Pink	48 pieces/carton
PT076M	8.1 x 8.1 x 7.2cm-Mix	48 pieces/carton

BETTA PARADISE

- Attractive rounded corners for safer handling

- Various fun & exciting colors

- Open top design for easy maintenance



PT072A

PT072B

PT072C

PT072D

PT072E



Code No.

PT072A
PT072B
PT072C
PT072D
PT072E

Dimension (LxWxH)

15 x 15 x 13.5cm-Crystal Clear
15 x 15 x 13.5cm-Crystal Yellow
15 x 15 x 13.5cm-Crystal Green
15 x 15 x 13.5cm-Crystal Blue
15 x 15 x 13.5cm-Crystal Pink

Volume

1.9 Litre
1.9 Litre
1.9 Litre
1.9 Litre
1.9 Litre

Packing

12 pieces/carton
12 pieces/carton
12 pieces/carton
12 pieces/carton
12 pieces/carton

DELUXE PARADISE

- Attractive rounded corners for safer handling
- Open top design for easy maintenance

- Various fun & exciting colors
- Comes with removable safety divider

- Energy - Saving



PT075A

PT075B

PT075C

PT075D

PT075E



** Super LED Clamping Lamp-Silver + Crystal Hang-On Filter 1 Included*

Code No.

PT075A
PT075B
PT075C
PT075D
PT075E

Dimension (LxWxH)

21.5 x 21.5 x 21cm-Crystal Clear
21.5 x 21.5 x 21cm-Crystal Yellow
21.5 x 21.5 x 21cm-Crystal Green
21.5 x 21.5 x 21cm-Crystal Blue
21.5 x 21.5 x 21cm-Crystal Pink

Volume

6.4 Litre
6.4 Litre
6.4 Litre
6.4 Litre
6.4 Litre

Packing

12 pieces/carton
12 pieces/carton
12 pieces/carton
12 pieces/carton
12 pieces/carton

CURVEY PET HOME

- High quality plastic tanks for general usage.
- Available in various sizes and colors.
- Crystal clear view and durable.

* Idea For: Guppy, Betta, Red Lobster, Beetle, Lizard, Turtle, Hermit Crab, Cricket, Small Reptile, Crab etc.



PT067

PT066

PT065

Code No.

PT065
PT066
PT067

Dimension(LxWxH)

18 x 11 x 13cm-Small
23 x 15 x 16cm-Medium
29 x 19.5 x 20cm-Large

Packing

12 pieces/carton
12 pieces/carton
6 pieces/carton

SWEET PET HOME

- High quality plastic tanks for general usage.
- Available in various sizes and colors.
- Crystal clear view and durable.



PT059

PT058

PT060

PT068

Code No.

PT058
PT059
PT060
PT068

Dimension(LxWxH)

18 x 11.5 x 14cm
23 x 15.2 x 16.5cm
30 x 19.5 x 24cm
37 x 20 x 24cm

Packing

24 pieces/carton
12 pieces/carton
6 pieces/carton
6 pieces/carton

AQUA BOX-G2

- Attractive and easy to setup
- Complete with top filter and lighting
- Flip open cover for ease of maintenance
- LED lamps for viewing pleasure
- Suitable for freshwater & marine setup
- Other filtration upon request



Code No	Dimension (LxWxH)	Volume	No. of Light	Flowrate of the Pump	Power Consumption	Packing
AT530ALED	40.8 x 25 x 47cm-Black	32 Litre	45 x 0.2W	600 L/H	7.5W	Individual
AT530BLED	40.8 x 25 x 47cm-Silver	32 Litre	45 x 0.2W	600 L/H	7.5W	Individual
AT530CLED	40.8 x 25 x 47cm-White	32 Litre	45 x 0.2W	600 L/H	7.5W	Individual
AT532ALED	62 x 36 x 54cm-Black	102 Litre	90 x 0.2W	800 L/H	13W	Individual
AT532BLED	62 x 36 x 54cm-Silver	102 Litre	90 x 0.2W	800 L/H	13W	Individual
AT532CLED	62 x 36 x 54cm-White	102 Litre	90 x 0.2W	800 L/H	13W	Individual

AQUACURV AQUARIUM TANK

- Includes mechanical, chemical and biological filtration for cleaner water.
- Complete with top filter, LED light and tank cover.
- Beautiful curved glass tank.
- Low energy consumption.
- Easy to maintain.



AquaCurv 320



AquaCurv 380



AquaCurv 450



Touch Switch



Pump



Filter Media



Filter Cotton

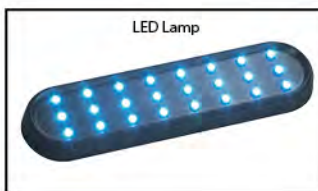

LED Lamp

Code No	Dimension (LxWxH)	Volume	Flowrate of the Pump	Pump Wattage	LED Wattage	Packing
AT626	32 x 23 x 34cm-Black	19 Litre	250 L/H	5.5W	4.0 W	Individual
AT628	32 x 23 x 34cm-White	19 Litre	250 L/H	5.5W	4.0 W	Individual
AT632	38 x 26.5 x 39.5cm-Black	32 Litre	250 L/H	5.5W	4.5 W	Individual
AT634	38 x 26.5 x 39.5cm-White	32 Litre	250 L/H	5.5W	4.5 W	Individual
AT659	45.5 x 29.5 x 45.5cm-Black	45 Litre	320 L/H	5.5W	7.0 W	Individual
AT661	45.5 x 29.5 x 45.5cm-White	45 Litre	320 L/H	5.5W	7.0 W	Individual

PARADOM AQUARIUM-G2 (FULL LED)

- All in one aquarium; just plug & use
- Compact & efficient top filtration designed for ease of maintenance
- LED lamps for increased brightness
- Easily accessible tank interior with fully openable flip cover
- Curved Glass Frontage for enhanced viewing pleasure
- Suitable for Freshwater & Marine setups



Code No	Dimension (LxWxH)	Volume of the Pump	NO. of LED	Flowrate	Power Consumption	Packing
AT450ALED	32.5 x 26 x 41cm-Black	30 Litre	32 x 0.2W	300 L/H	5W	Individual
AT450BLED	32.5 x 26 x 41cm-Silver	30 Litre	32 x 0.2W	300 L/H	5W	Individual
AT451ALED	38.5 x 28 x 43cm-Black	40 Litre	45 x 0.2W	600 L/H	7.5W	Individual
AT451BLED	38.5 x 28 x 43cm-Silver	40 Litre	45 x 0.2W	600 L/H	7.5W	Individual
AT452ALED	45 x 33 x 45cm-Black	63 Litre	60 x 0.2W	600 L/H	10W	Individual
AT452BLED	45 x 33 x 45cm-Silver	63 Litre	60 x 0.2W	600 L/H	10W	Individual
AT453ALED	62 x 40 x 53cm-Black	108 Litre	90 x 0.2W	800 L/H	13W	Individual
AT453BLED	62 x 40 x 53cm-Silver	108 Litre	90 x 0.2W	800 L/H	13W	Individual

ECO 45 / 60 AQUARIUM TANK

True Functional Design / Simplicity is more.

- Internal Filtration (Biological & Mechanical)
- Full LED Illumination
- Removable cover for easy maintenance
- Energy Saving

* ECO45 / 60 is a sleek aquarium tank that combines function with aesthetics.



Features:

1. Energy Saving

Lower electricity consumption results in greater saving for you over time.

2. Removable Cover with Feeding Flap

We've designed a cover that is durable and strong, yet still easy to lift when maintaining your tank. A full length flap is included for ease of feeding and access.

3. LED Lighting System

The energy-saving LED lighting system incorporated under the sturdy tank lid provides good light penetration and creates beautiful, stunning ripple effects.

4. Quality Glass Workmanship

Good glass and silicon workmanship ensures tank remain leak proof for many years of fish-keeping pleasure.

5. Internal Filtration

The compact Internal Filter offers efficient biological and mechanical filtration to keep your aquarium water clean and clear.



Code No	Dimension (LxWxH)	Volume	No. of Light	Flowrate of the Pump	Power Consumption	Packing
AT834	45 x 30 x 35cm	45 Litre	10.5W (21 x 0.5W) White Energy Saving LED	750 L/H	6W	Individual
AT608A	60 x 30 x 35cm	63 Litre	12W (24 x 0.5W) White Energy Saving LED	950 L/H	10W	Individual

AQUARIUM STARTER KIT



AT668

AT669

AT670

Includes:

- Scratch Resistant Glass Aquarium
- Decorative Plant
- Hang On Power Filter with Media
- Coloured Gravel
- Rigid Clear Top Cover
- Net

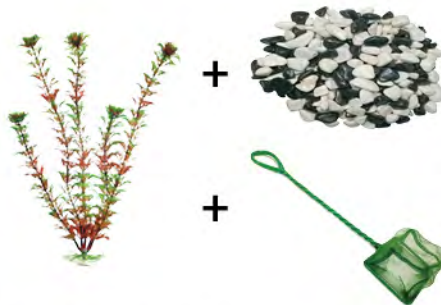

or



Note: Decoration Plant is for illustration only. Actual product may not be the same as shown.

Code No	Volume	Dimension (LxWxH)	Type of Filter	Packing
AT668	12 Litre	30 x 16 x 24cm	Crystal Hang-On Filter 1	Individual
AT669	21 Litre	36 x 22 x 26.5cm	Crystal Hang-On G2 Filter 2	Individual
AT670	30 Litre	40 x 25.5 x 29cm	Crystal Hang-On G2 Filter 2	Individual

U-TANK SERIES

- Uniquely designed tanks made with high quality resin glass.
- High production quality control and resistant to breakage.
- High class design style in various shape and sizes.



AT364



AT364Super



AT364XL



AT364L



AT364M



AT364S

Code No.	Dimension (LxWxH)	Glass Thickness	Packing
AT364S	30 x 17 x 20cm	5 mm	Individual
AT364M	35 x 21 x 23cm	5 mm	Individual
AT364L	40 x 25 x 26cm	5 mm	Individual
AT364XL	44 x 29 x 30cm	5 mm	Individual
AT364SUPER	50 x 33 x 34cm	5 mm	Individual
AT364	50 x 33 x 34cm	5 mm	5 in 1 Set



Super

XL

S

Code No.	Dimension(LxWxH)	Glass Thickness	Packing
AT1419	18 x 13.5 x 15cm	4mm	Individual
AT1422	45 x 20 x 25cm	4mm	Individual
AT1423	60 x 22 x 30cm	4mm	Individual

4 IN 1 TANK

- Uniquely designed tanks made with high quality resin glass.
- High class design style in various shape and sizes.
- High production quality control and resistant to breakage.



Code No.
AT325

Dimension(LxWxH)
44 x 38 x 30cm

Glass Thickness
3mm

Packing
4 in 1 set

ECONOMY TANK

- Tank made with high quality resin glass
 - Available in different sizes and design
 - High production quality control
 - Made to measure
- * Customized tank available



AT193

AT195

AT201

AT224

Code No.

AT193

AT195

AT201

AT224

Dimension(LxWxH)

60 x 30 x 45cm

60 x 30 x 36cm

60 x 45 x 45cm

91 x 45.7 x 45.7cm

Glass Thickness

5mm

5mm

5mm

6mm (Base-8mm)

Packing

Individual

Individual

Individual

Individual

TANK

- Uniquely designed tanks made with high quality resin glass.
- High production quality control and resistant to breakage.



Code No.

AT145

Dimension(LxWxH)

61 x 30 x 36cm

Volume

54 Litre

Glass Thickness

3mm

Packing

Individual

FIBRE TANK

- Can be customized
- Cater for individual requirement
- Available in various dimension
- Suitable for all weather use
- Good workmanship
- All round bracing for reinforcement (4 ft above)



Multi Stage Filter Box



Fiber Tank



Fiber Tank With Build-in Filter



Fiber Tank With Filter Box



Code No	Description	Dimension (LxWxH)	Packing
FT003	Filter Box	40 x 12 x 15inch	Individual
FT004	Filter Box	50 x 15 x 18inch	Individual
FT005	Fibre Tank	3ft x 2ft x 15inch	Individual
FT006	Fibre Tank	4 x 2.5 x 1.5ft	Individual
FT007	Fibre Tank	4 x 3 x 2ft	Individual
FT008	Fibre Tank	5 x 3 x 1.5ft	Individual
FT009	Fibre Tank	5 x 3 x 2ft	Individual
FT010	Fibre Tank	6 x 3 x 2ft	Individual
FT011	Fibre Tank	6 x 3 x 2.5ft	Individual
FT012	Fibre Tank	8 x 4 x 2.5ft	Individual

PLASTIC TANK

- Available in various dimension
- Suitable for all weather use
- Cater for individual requirement
- Superior quality

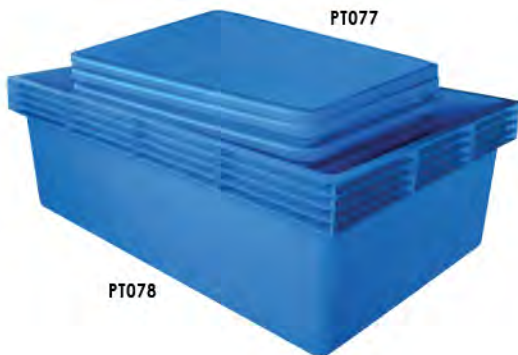

PT078

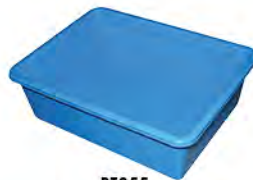

PT055



PT056

PT057



Code No	Dimension (LxWxH)	Packing
PT055	67.5 x 50 x 21.3cm	Individual
PT056	75 x 57.5 x 23.8cm	Individual
PT057	80 x 62.5 x 27.5cm	Individual
PT077	120 x 75 x 45cm	Individual
PT078	180 x 120 x 60cm	Individual

UNVEILING THE WORLD'S FIRST

A team of scientists from Qian Hu and a local research company has scored a first by jointly developing the revolutionary Hydro-Pure Technology that is capable of enhancing the natural filtration processes in aquariums. This energy-efficient Hydro-Pure Technology is eco-friendly and truly the first of its kind in the world. It can also be applied to other areas in the ornamental industry as it promotes a natural, chemical free environment for all aquatic lives.



1) What is Hydro-Pure Technology?

Hydro-Pure Technology is a patented water detoxifying and depurating technology for applications in both Marine and freshwater Aquatic Hobby. It consists of two electro-plates to energize a cartridge box containing special Cata-Pure Catalyst Media to generate strong reactive Hydroxyl ($\bullet\text{OH}$) radicals, which is the key to the detoxifying and depurating reactions process.



2) How does Hydro-Pure Technology works?

We provided the below diagram to help you understand the technology better. Phase 1 is where your aquarium water enters the Hydro-Pure Technology chamber, Phase 2 is where the reaction takes place and Phase 3 is the end result.

Phase 1

- Aquarium water containing Protein, Ammonia (NH_3) and Nitrite (NO_2^-)

Phase 2

- Cata-pure Media reaction produces reactive Hydroxyl Radicals ($\bullet\text{OH}$) from water
- Hydroxyl Radicals ($\bullet\text{OH}$) reduces Protein, toxic wastes, e.g. Ammonia (NH_3) and Nitrite (NO_2^-), and odour from Sulphur-based by-products

Phase 3

- Biologically clean and healthy water for fish and invertebrates

3) How does Hydro-Pure Technology benefit my fish keeping experience?

- Detoxifies harmful wastes like Ammonia (NH_3) and Nitrite (NO_2^-) to help hobbyists maintain purer water and a healthier aquarium
- Breaks down Protein and nutrients
- Helps reduce aquarium startup time (Nitrogen Cycle) and prevent New Tank Syndrome
- Minimize frequency of water change thus saving time and greater savings on your utility bills
- Minimize unpleasant smell from aquarium water
- Improves water clarity
- For Marine and Freshwater aquarium applications

Hydro-Pure Technology is suitable for marine and freshwater fish tanks of all sizes, all types of fishes, plants and live corals including all levels of stocking density. It also helps in the prevention of New Tank Syndrome especially in Marine tanks application, perfect for any applications that requires pristine water condition of safe and stable level of Ammonia, nitrites and nitrates acceptable for aquatic life form.

Hydra Prime System V3



Prevent New Tank Syndrome

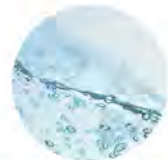

Minimize frequency of water change thus saving time and greater savings on your utility bills



Maintain purer and healthier water



Minimize unpleasant smell

The development of Hydra Prime System V3 is a journey that is continuously ongoing through our engagement with the Aquaculture and Koi community.

We first understand your needs, / then we meet your needs.

FEATURES

- Helps to induce the natural coloration of Koi.
- Detoxifies harmful wastes like Ammonia (NH₃) and Nitrite (NO₂⁻) to maintain healthy water conditions.
- Minimize frequency of water change thus saving time and greater savings on your utility bills.
- Increases water DO (dissolved oxygen) levels.
- Minimizes unpleasant smell from pond water.
- Improves water clarity.
- Small & removable 3DM Filter Compartment. Easy to install. Easy to maintain.
- Sleek and aesthetically pleasing cabinet design.

APPLICATIONS

Ponds, Commercial Fishkeeping Facilities and Big Tanks

DETAIL VIEW

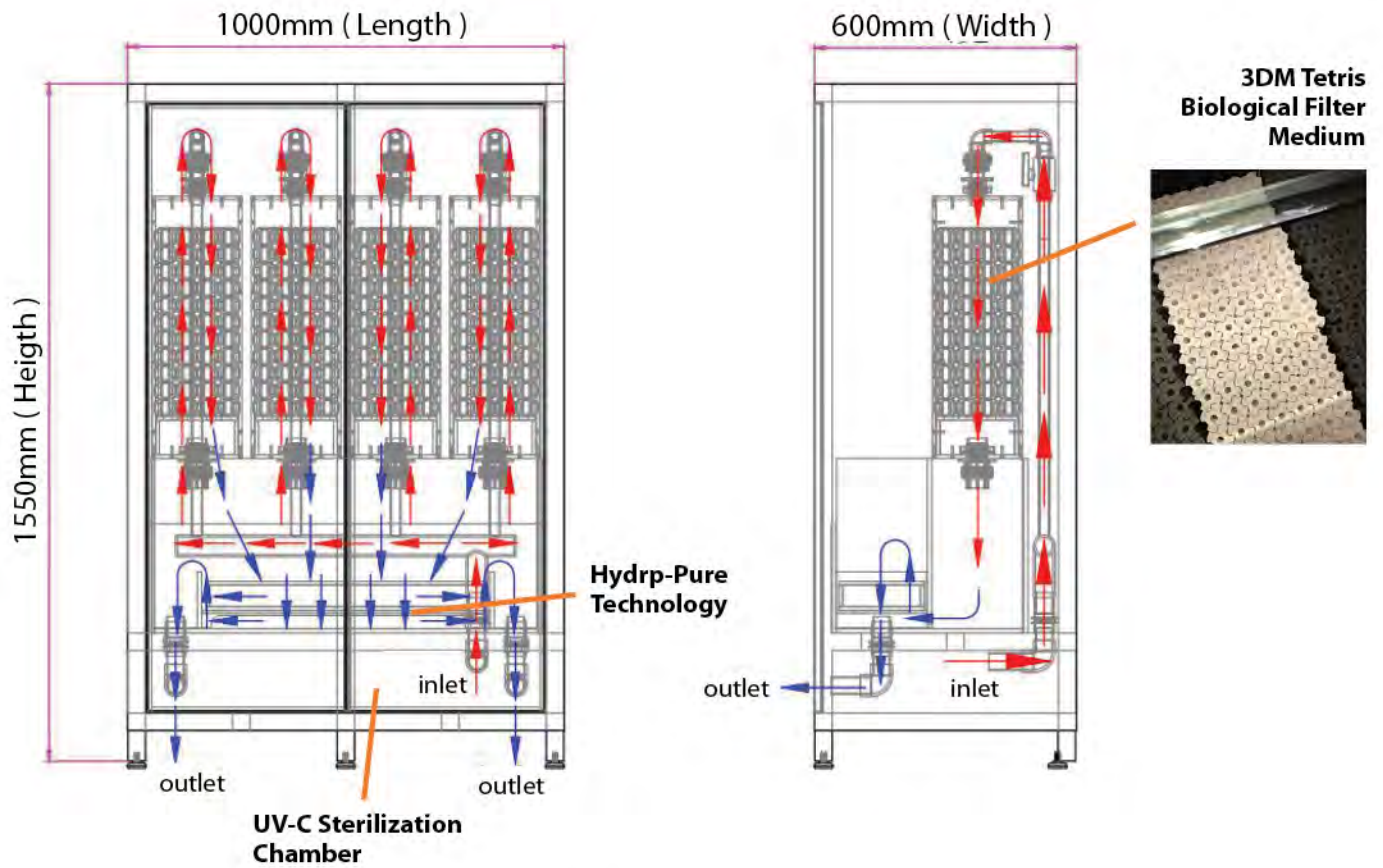
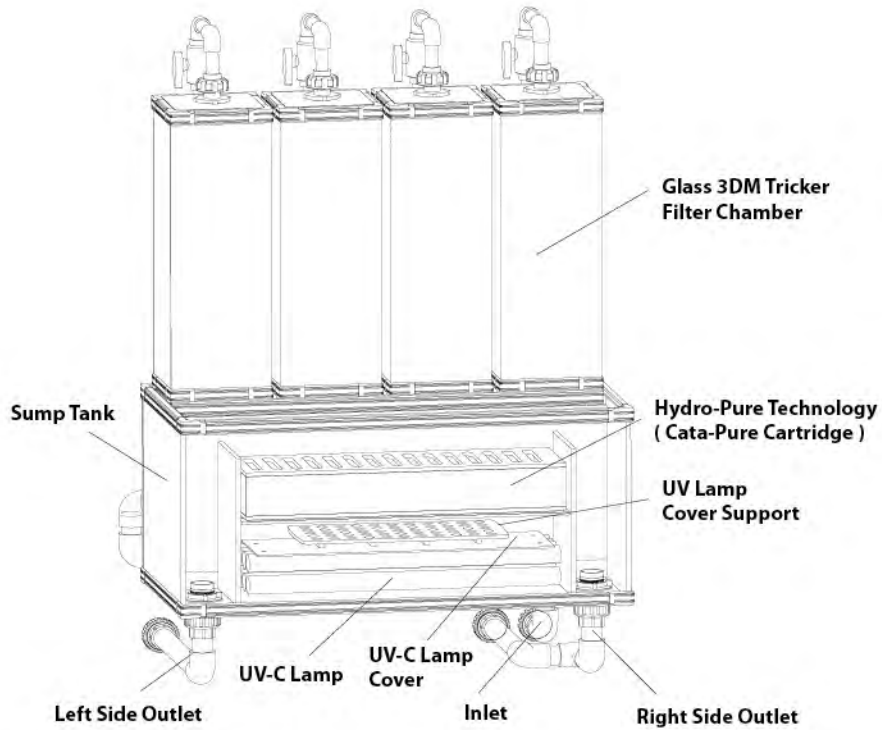

AVAILABLE MODELS



Specification	EF131 - Minimalist Style	EF132 - Shoji Style
Overall Dimensions (mm)	1000 x 600 x 1550mm	1000 x 600 x 1550mm
Max Power	450W (water pump power calculated at 170W)	450W (water pump power calculated at 170W)
Recommended Water Volume	10 - 30 Tonnes	10 - 30 Tonnes
UV Sterilization	Aquazonic UV007 30W x 8pcs	Aquazonic UV007 30W x 8pcs
3DM Filter Medium (Litre)	200L	200L
Hydro - Pure Technology	4kg Cata-pure with controller system	4kg Cata-pure with controller system
Water Pump	Aquazonic WP087 Amphi Plus 170W (20000 L / H) x 1pc (For Export Market)	Aquazonic WP087 Amphi Plus 170W (20000 L / H) x 1pc (For Export Market)

Benefits of Hydro-Pure Technology

- Detoxifies harmful wastes like Ammonia (NH₃) and Nitrite (NO₂⁻) to help hobbyists maintain purer water and a healthier aquarium
- Breaks down Protein and nutrients
- Helps reduce aquarium startup time (Nitrogen Cycle) and prevent New Tank Syndrome
- Minimize frequency of water change thus saving time and greater savings on your utility bills
- Minimize unpleasant smell from aquarium water
- Improves water clarity

CUSTOMER SHOWCASES

 **Mr Pan • Hydra Prime V1 & V3 - China**



 **Mr Tam • Hydra Prime V1 - China**



 **Mr Wu • Hydra Prime V1- Hong Kong**



 **Odakan Koi Farm • Hydra Prime V2 & V3 - Japan**

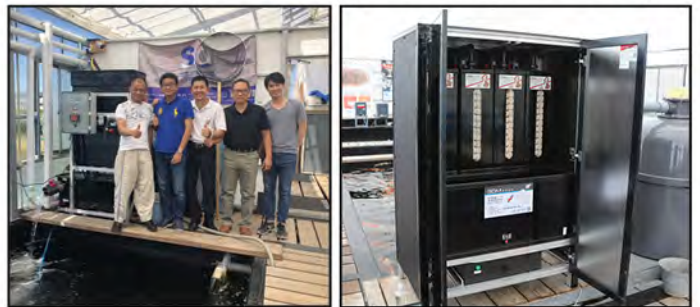

 **Dainichi Koi Farm • Hydra Prime V2 & V3 - Japan**



Hydra

FILTRON

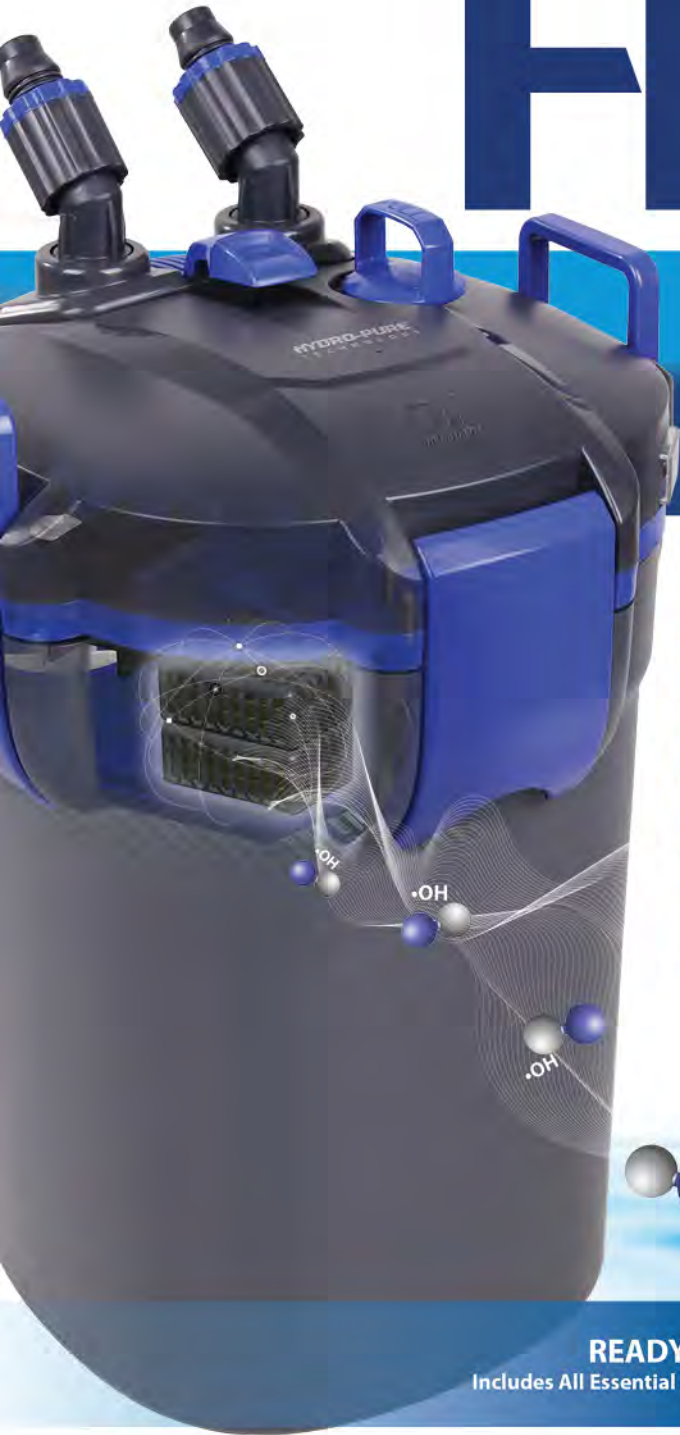

- ✓ Prevents New Tank Syndrome
Verhindert das Neue-Baekten-Syndrom
- ✓ Reduces Water Change Frequency
Wasser muss nicht mehr so häufig ausgetauscht werden
- ✓ Produces Crystal-Clear Water
Sorgt für kristallklares Wasser
- ✓ Reduces Water Odours
Verringert modrigen Geruch des Wasser



READY TO USE
Includes All Essential Filter Media



MARINE & FRESH WATER

3 YEARS WARRANTY

NOTABLE FEATURES

- **4-Stage Water Purification** | Hydra Filtron's 4-Stage Water Purification, goes beyond the conventional 3 stage filtration (Mechanical, Biological, Chemical), with the incorporation of the revolutionary Hydro-pure Technology that uses Hydroxyl Radicals ($\cdot\text{OH}$) to accelerate the startup time from the usual 4-5 weeks to within 1 week, reduces water odour, and retains a crystal clear tank. The result is a cleaner and healthier aquarium the natural way without any harmful chemical
- **One Pull Priming** | A quick pull and push of the Primer draws water into the canister making it ready to use
- **Valve for Easy Maintenance** | Valve controls at the inlet and outlet pipes eliminate the hassle of dealing with water spills during maintenance
- **Surface Skimmer** | Removes unsightly surface oil film to improve oxygen exchange and increase light penetration at water surface

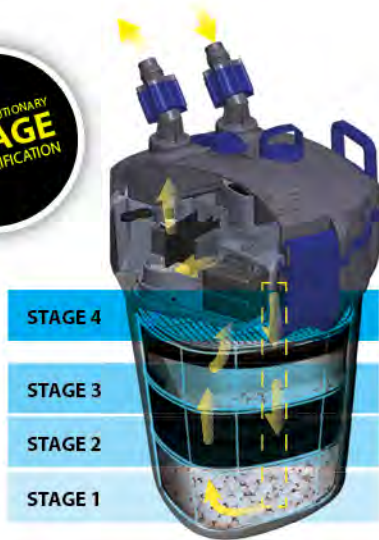

STAGE	DESCRIPTION	FUNCTIONS
STAGE 1	3DM Nuggets	<ul style="list-style-type: none"> Breaks down large solids and traps suspended particles Provides a high surface area for beneficial bacteria which helps break-down toxic waste (e.g. Ammonia and Nitrites) biologically
STAGE 2	Biotrap Sponge	<ul style="list-style-type: none"> Breaks down finer solids and traps suspended particles Provides surface area for beneficial bacteria for further biological purification of toxic waste
STAGE 3	3DM Beads	<ul style="list-style-type: none"> Provides highest surface area for beneficial bacteria which helps break-down toxic waste biologically
	Fine Filter Wool	<ul style="list-style-type: none"> Removes fine particles
STAGE 4	Carbon Pad	<ul style="list-style-type: none"> Absorbs dissolved organic compound and heavy metals to maximize efficiency of the Hydro-Pure Technology
		Hydro-Pure Technology

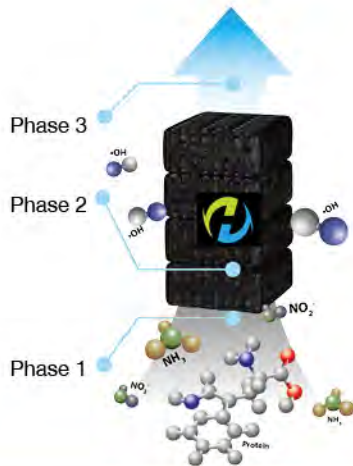

Hydro-Pure Technology (The 3 Phases)

Phase 1

- Aquarium water containing Protein, Ammonia (NH₃) and Nitrite (NO₂-)

Phase 2

- Cata-pure Media reaction produces reactive Hydroxyl Radicals (•OH) from water

- Hydroxyl Radicals (•OH) reduces Protein, toxic wastes, e.g. Ammonia (NH₃) and Nitrite (NO₂-), and odour from Sulphur-based by-products

Phase 3

- Biologically clean and healthy water for fish and invertebrates

TECHNICAL SPECIFICATIONS

MODEL	HYDRA FILTRON 1000	HYDRA FILTRON 1500	HYDRA FILTRON 1800
For Aquarium Size Up To	80 - 300 L 20 - 80 US Gal	150 - 600 L 40 - 160 US Gal	200 - 800 L 50 - 210 US Gal
Product Size	240 x 240 x 363 mm 9.5" x 9.5" x 14.3"	272 x 272 x 403 mm 10.7" x 10.7" x 15.9"	300 x 300 x 443 mm 11.8" x 11.8" x 17.5"
Pump Flow Rate	1000 L/H 270 US Gal	1500 L/H 400 US Gal	1800 L/H 480 US Gal
Circulation Flow Rate	600 L/H 160 US Gal/H	900 L/H 240 US Gal/H	1100 L/H 290 US Gal/H
Filter Media Baskets Volume	4.7 L 1.3 US Gal	7.0 L 1.9 US Gal	10.0 L 2.7 US Gal
Filter Media Baskets	3 pcs	3 pcs	4 pcs
Power Consumption	13 W	23 W	32 W
Inlet & Outlet Hose	ø 16 / 22 mm inner ø 5/8"	ø 19 / 25 mm inner ø 3/4"	ø 19 / 25 mm inner ø 3/4"
Cable Length	2.0 m 78.0"	2.0 m 78.0"	2.0 m 78.0"
Max Height	1.4 m 55.0"	2.0 m 78.0"	2.4 m 94.5"
Cata-Pure Cartridge(s)	2 pcs	3 pcs	4 pcs

Code No.

Description

Specification

Power Consumption

Packing

EF125	Hydra Filtron 1000
EF126	Hydra Filtron 1500
EF127	Hydra Filtron 1800

24cm x 24cm x 36.3cm
27.2cm x 27.2cm x 40.3cm
30cm x 30cm x 44.3cm

13W
23W
32W

2 pieces/carton
2 pieces/carton
Individual

HYDRA FILTRON REPLACEMENT FILTER MEDIA

3DM BEADS & 3DM NUGGETS

- pH Neutral
- Tough and durable

- Bio-mechanical filtration
- Flaking of bio-membrane

- Longer water retention time
- Macro-porous with high surface area provides ideal conditions for Beneficial Bacteria



RP377



RP380

3DM Nuggets Bio-Mechanical Filter Media encourages uniform water circulation through-out the canister and provides high surface area for the colonization of beneficial bacteria for efficient biological decomposition of waste.

The continuous cavities and interlinked micro-tunnels of the 3DM Beads Biological Media increase the overall effective surface area and create ideal conditions for billions of beneficial bacteria. The beneficial bacteria consumes toxic ammonia and converts it to nitrites and then to nitrates, ultimately breaking down into Nitrogen under the right conditions.

Code No.

RP377
RP380

Description

3DM Nuggets
3DM Beads

Specification

ø18-20mm, length:15-17mm
ø7-9mm

Packing

1litre/box / 12 boxes/carton
1litre/box / 12 boxes/carton

CATA-PURE CARTRIDGES

- Prevention of cloudy water
- Minimizes unpleasant water smell
- Helps prevent "New Tank Syndrome"
- Purification of water & pH neutral



RP208A



RP208

Code No.

RP208
RP208A

Description

Cata-Pure Cartridge - 1 pcs
Cata-Pure Cartridge - 1 box (4 pcs)

Packing

36 pieces/carton
24 boxes/carton

AQUARIUM HOSE

- Good flexibility and retain shape well
- Non-toxic, Phenol-free material
- Aging-proof
- Tough and durable
- Durable



Code No.

AA216
AA217
AA218

Description

Aquarium Hose
Aquarium Hose
Aquarium Hose

Specification

ø12 x 16mm, length: 50m
ø16 x 22mm, length: 30m
ø19 x 25mm, length: 20m

Color

Translucent Black
Translucent Black
Translucent Black

Packing

1 roll/box
1 roll/box
1 roll/box

FINE FILTER WOOL

- Mechanical filtration
- Physically trap finer solids and suspended particles to keep your water clear



RP370



RP371



RP372

Code No.	Description	Specification	Size	Packing
RP370	Fine Filter Wool 1000	for Hydra Filtron 1000	182.5 x 182.5 x 30mm	3 pieces/box / 36 boxes/carton
RP371	Fine Filter Wool 1500	for Hydra Filtron 1500	204.3 x 204.3 x 30mm	3 pieces/box / 36 boxes/carton
RP372	Fine Filter Wool 1800	for Hydra Filtron 1800	228.8 x 228.8 x 30mm	3 pieces/box / 36 boxes/carton

BIOTRAP SPONGE

- Bio-Mechanical filtration
- Physically trap finer solids and suspended particles to keep your water clear
- Long lasting and durable
- Good porosity that provide good conditions for beneficial bacteria



RP373



RP374



RP375

Code No.	Description	Specification	Size	Packing
RP373	Biotrap Sponge 1000	for Hydra Filtron 1000	182.5 x 182.5 x 30mm	2 pieces/box / 36 boxes/carton
RP374	Biotrap Sponge 1500	for Hydra Filtron 1500	204.3 x 204.3 x 30mm	2 pieces/box / 36 boxes/carton
RP375	Biotrap Sponge 1800	for Hydra Filtron 1800	228.8 x 228.8 x 30mm	2 pieces/box / 36 boxes/carton

CARBON PAD

- Adsorbs colours
- Adsorbs water odours
- Adsorbs dissolved organic compounds and heavy metals to maximize efficiency of Hydro-Pure Technology



RP388



RP389



RP390

Code No.	Description	Specification	Size	Packing
RP388	Carbon Pad 1000	for Hydra Filtron 1000	182.5 x 182.5 x 6mm	3 pieces/box / 36 boxes/carton
RP389	Carbon Pad 1500	for Hydra Filtron 1500	204.3 x 204.3 x 6mm	3 pieces/box / 36 boxes/carton
RP390	Carbon Pad 1800	for Hydra Filtron 1800	228.8 x 228.8 x 6mm	3 pieces/box / 36 boxes/carton



FRESHWATER Hydra

AQUATIC DEPURATOR

- ✓ Breaks Down Protein and Nutrients
- ✓ Detoxify Ammonia (NH₃) & Nitrite (NO₂-)
- ✓ Create and Maintain Safe and Stable Pristine "Hydro-Pure Water"

The Hydra is the world's first Aquatic Depurator powered by Hydro-pure Technology, combining it with Biological Filtration into one revolutionary filtration system. The Hydra enhances the natural filtration and detoxification processes by more than 50%. This constant detoxification process results in biologically clean and safe pristine water quality for your fishes, maintains water quality effectively thus reducing frequency of water change.

Note: Not for use in marine water.



IF120

IF121

IF122

IF123

Nozzle attachment



Usable with hoses of 12 / 16mm and 16 / 22 mm

The Hydra can be used with small size water features when fitted with the Nozzle attachment.

Code No.	Description	Specification	Power Consumption	Cata-pure	Packing
IF120	Freshwater Hydra 20	For Tank Between 50 - 100 L (400 L/H)	6W	1 piece	12 pieces/carton
IF121	Freshwater Hydra 30	For Tank Between 100 - 200 L (600 L/H)	7.5W	1 piece	12 pieces/carton
IF122	Freshwater Hydra 40	For Tank Between 200 - 500 L (800 L/H)	10W	2 pieces	12 pieces/carton
IF123	Freshwater Hydra 50	For Tank Between 500 - 800 L (1000 L/H)	15W	2 pieces	12 pieces/carton

FRESHWATER

Hydra

AQUATIC DEPURATOR

STREAM

✓ Breaks Down Protein and Nutrients

✓ Detoxify Ammonia (NH₃) & Nitrite (NO₂)

✓ Create and Maintain Safe and Stable Pristine "Hydro-Pure Water"



The Hydra Stream is the world's first Aquatic Depurator powered by Hydro-pure Technology. It greatly improves your existing aquatic filtration system by enhancing the natural filtration and detoxification processes by more than 50%. This constant detoxification process results in biologically clean and safe pristine water quality for your fishes, maintains water quality effectively thus reducing frequency of water change.

Note: Not for use in marine water.



EF147 / EF150



EF148 / EF151



EF149 / EF152

Set-up Illustration

Suction Cup or Hang On (optional)



Internal Filter



Top Trickle Filter

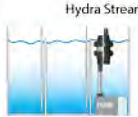

Sump Tank

Suction Cup or Hang On (optional)



Hobby Pump

Suction Cup or Hang On (optional)



Hobby Pump



Hydra Stream External Filter

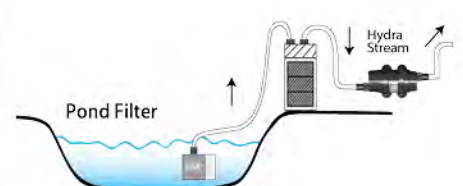

Pond Filter

Code No.	Description	Specification	Power Consumption	Cable Length	Cata-pure	Packing
EF147	Freshwater Hydra Stream 1	For Tank <300 (300 - 1000 L/H)	1.1W	1.5m	4 pieces	12 pieces/carton
EF148	Freshwater Hydra Stream 2	For Tank <600 (500 - 2000 L/H)	1.3W	1.5m	6 pieces	12 pieces/carton
EF149	Freshwater Hydra Stream 3	For Tank <1000 (800 - 3000 L/H)	1.5W	1.5m	8 pieces	12 pieces/carton
EF150	Freshwater Hydra Stream 1	For Tank <300 (300 - 1000 L/H)	1.1W	5m	4 pieces	12 pieces/carton
EF151	Freshwater Hydra Stream 2	For Tank <600 (500 - 2000 L/H)	1.3W	5m	6 pieces	12 pieces/carton
EF152	Freshwater Hydra Stream 3	For Tank <1000 (800 - 3000 L/H)	1.5W	5m	8 pieces	12 pieces/carton

HYDRA - INTERNAL FILTER

AQUATIC DEPURATOR - Marine & Freshwater

Qian Hu has meticulously developed HYDRA Aquatic Depurator (Powered by "HYDRO-PURE technology") that constantly produces OH radicals to detoxify harmful toxins in the water, HYDRA Aquatic Depurator makes fishkeeping a breeze.

- Minimizes frequency of water change thus saving time and greater savings on their utility bills.
- Reduces mortality rate of fish by maintaining safe and stable pristine "Hydro-Pure Water".
- Minimizes unpleasant smell from aquarium water.

HYDRA Aquatic Depurator (Powered by "HYDRO-PURE technology") comes in various sizes that best suits every aquarium; be it Marine or Freshwater.

- Breaks Down Protein and Nutrients
- Detoxify Ammonia (NH₃) & Nitrite (NO₂)
- Create and Maintain Safe and Stable Pristine " Hydro-Pure Water "



Code No	Description	Specification	Power Consumption	Packing
IF101	Hydra 20	For Tank Between 50-100 L (400 L/H)	6 W	12 pieces/carton
IF102	Hydra 30	For Tank Between 100-200 L (600 L/H)	7.5 W	12 pieces/carton
IF103	Hydra 40	For Tank Between 200-500 L (800 L/H)	10 W	12 pieces/carton
IF104	Hydra 50	For Tank Between 500-800 L (1000 L/H)	15 W	12 pieces/carton

CATA-PURE CARTRIDGE

Cartridge for Hydra Products:

Hydra Filtron / Hydra Internal Filter / Hydra Stream



RP208



RP208A

Code No	Description	Packing
RP208	Cata-Pure Cartridge-1 pc	36 pieces/carton
RP208A	Cata-Pure Cartridge-1 box (4pcs)	24 boxes/carton

HYDRA STREAM

AQUATIC DEPURATOR - Marine & Freshwater

Hydro-Pure Technology greatly improves your existing aquatic filtration system by constantly breaking down Protein, detoxifying Ammonia (NH₃) and Nitrite (NO₂-), reducing overall level of organic nutrients much faster than normal biological filtration. This constant detoxification process results in biologically clean and safe pristine water quality for your fishes, maintains water quality effectively thus reducing frequency of water change.

- Breaks Down Protein and Nutrients
- Detoxify Ammonia (NH₃) & Nitrite (NO₂-)
- Create and Maintain Safe and Stable Pristine "Hydro-Pure Water"

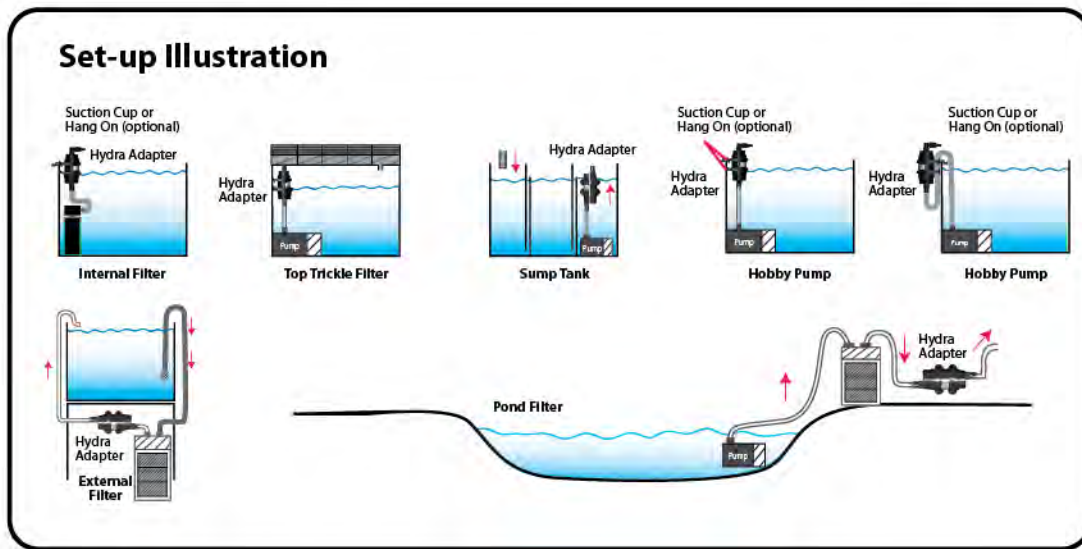

Code No	Description	Flow Rates	Specification	Power Consumption	Cable Length	Packing
EF112	Hydra Stream 1	300-1000 L/H	For Tank <300	1.1 W	1.5m	12 pieces/carton
EF113	Hydra Stream 2	500-2000 L/H	For Tank <600	1.3 W	1.5m	12 pieces/carton
EF114	Hydra Stream 3	800-3000 L/H	For Tank <1000	1.5 W	1.5m	12 pieces/carton
EF115	Hydra Stream 1	300-1000 L/H	For Tank <300	1.1 W	5m	12 pieces/carton
EF116	Hydra Stream 2	500-2000 L/H	For Tank <600	1.3 W	5m	12 pieces/carton
EF117	Hydra Stream 3	800-3000 L/H	For Tank <1000	1.5 W	5m	12 pieces/carton

HYDRA STREAM SYSTEM

Hydra Stream System is a water deparator for large volumes of water, e.g. fish farms, aquaculture, ponds and big tanks.

- Detoxifies harmful wastes like Ammonia (NH₃) and Nitrite (NO₂⁻) to maintain healthy water conditions
- Minimize frequency of water change thus saving time and greater savings on your utility bills
- Increases water DO (Dissolved Oxygen) levels
- Minimize unpleasant smell from aquarium water
- Improves water clarity

Application

Pool / fish pond / aquariums usage

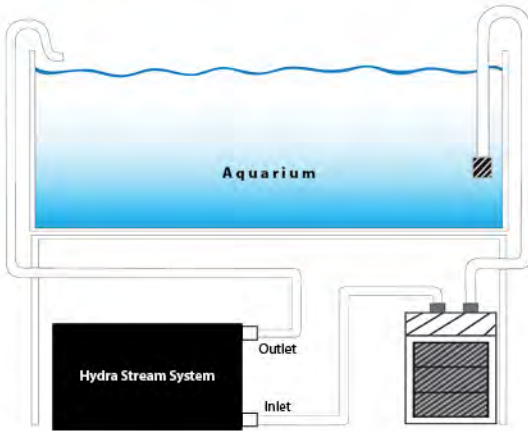

• To avoid accumulation of detritus and sludge within the Hydra Stream Unit, please install a pre-filter (mechanical filtration system) before the Hydra Stream Unit.

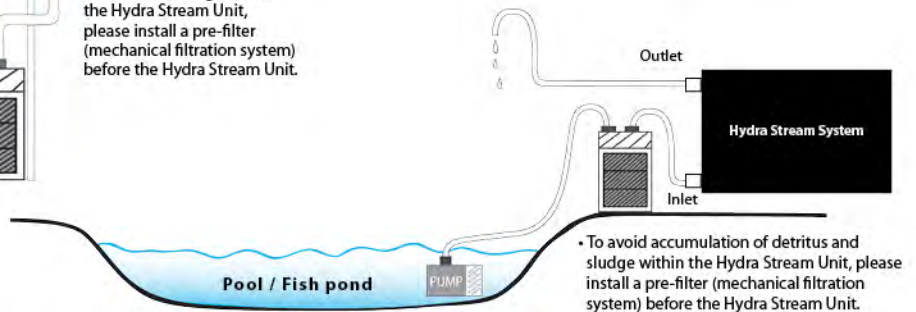

• To avoid accumulation of detritus and sludge within the Hydra Stream Unit, please install a pre-filter (mechanical filtration system) before the Hydra Stream Unit.



Water-proofed Power Supply Unit for added safety.



Water circulation is designed for maximum purification effect.



Hydro-Pure Technology helps reduce water change frequency. This benefits big facilities by allowing them to reduce utility and labor costs.

Code No	Description	Specification	Power Consumption	Treatment Vol	Flow Rate	Packing
EF121	Hydra Stream System 6	Hydra Stream 3 (6-in-1)	9W	2400-15000	6000-30000L/H	Individual
EF120	Hydra Stream System 8	Hydra Stream 3 (8-in-1)	12W	3200-20000	8000-40000L/H	Individual
EF119	Hydra Stream System 10	Hydra Stream 3 (10-in-1)	15W	4000-25000	10000-50000L/H	Individual

HYDRA NANO PLUS

AQUATIC DEPURATOR - Marine & Freshwater

Hydro-Pure Technology greatly improves your existing aquatic filtration system by constantly breaking down Protein, detoxifying Ammonia (NH_3) and Nitrite (NO_2^-), reducing overall level of organic nutrients much faster than normal biological filtration. This constant detoxification process results in biologically clean and safe pristine water quality for your fishes, maintains water quality effectively thus reducing frequency of water change.

- Breaks Down Protein and Nutrients
- Detoxify Ammonia (NH_3) & Nitrite (NO_2^-)
- Create and Maintain Safe and Stable Pristine "Hydro-Pure Water"
- Built-in Surface Skimmer

* Can be use for terrarium tanks.



IF105



Code No	Flow Rates	Specification	Power Consumption	Packing
IF105	300 L/H	For Tank <50L	5 W	24 pieces/carton
RP363	-	Cata-Pure Cartridge	-	48 pieces/carton

3DM BB - Mech Chamber (ϕ 45, 60, 75, 90, 105cm)

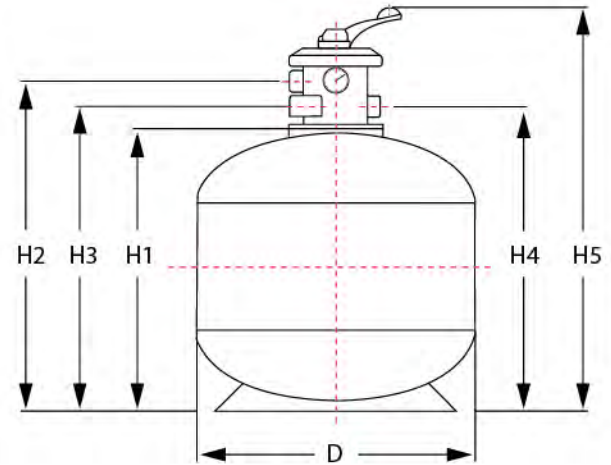

Code	EF136	EF137	EF138	EF145	EF139
Model	BB Mech 450	BB Mech 600	BB Mech 750	BB Mech 900	BB Mech 1050
Main Body Diameter (mm)	450	600	750	900	1050
Chamber Volume (L)	48	115	222	380	525
Bio Bead Volume (L)	40	88	184	328	424
Piping Diameter (mm / inch)	50 / 1.5" (48)	50 / 1.5" (48)	63 / 2" (60)	63 / 2" (60)	63 / 2" (60)
Recommended Flow Rate L / H	5000 - 10000	10000 - 20000	10000 - 30000	20000 - 50000	20000 - 50000
Recommended for Water Volume	<5000L	<20000L	<30000L	<40000L	<50000L
Body Height (H1)	485	620	765	900	1065
Inlet Height (H2)	599	744	903	1038	1203
Outlet Height (H3)	535	680	829	964	1129
Waste Outlet Height (H4)	535	680	829	964	1129
Total Height (H5)	740	885	1080	1215	1380

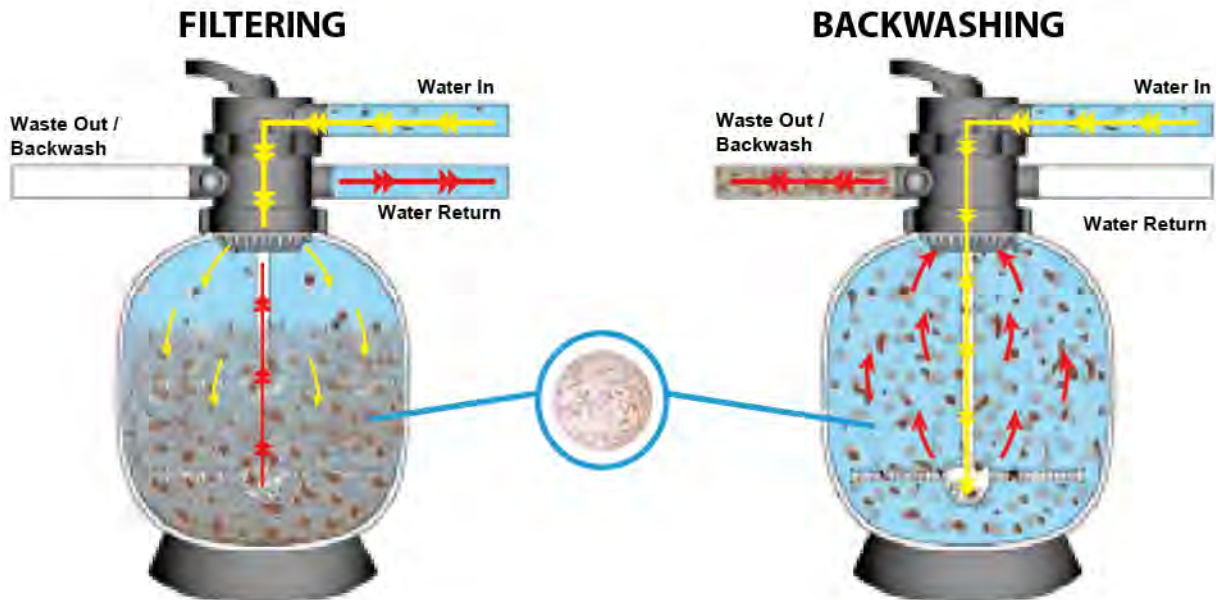
Illustration :**Product Features :**

01. Automatic system with high-efficiency filtration, multi-directional valve lever for simple operation, high-strength fiber-glass material production.
02. Unique 3DM high porosity, ultra-light round bead type filter sand, mechanical and biological filtration all-in-one, it traps dirt between sand beads and with the special biofilm on the surface, it can further capture tiny micro dirt. At the same time, it has the unique function of natural dirt reduction.
03. 3DM porous ultra-light round bead type filter sand, requires lower pressure power to operate, this it is energy saving, and protects the environment.
04. Special 3DM porous ultra-light round bead type filter sand has a good biological function and will not cause dead spots in the sand chamber. It has great inner water circulation and does not produce bad odor. There is essentially no B.O.D, C.O.D and hydrogen sulfide present.
05. Pressured filtration flow is a few fold more effective than conventional "flow through" filter sump with filter sponge and filter brushes.
06. Compact small size, it can easily replace traditional filter sump, it saves space and reduces the cost of sump construction greatly. With the modular based system, it can be added at any time according to the needs of the user and the number of fish, thus solving the troubles for the industry players and hobbyist.
07. Comes with manual stirrer lever, the user can turn the stirrer lever while performing back-flushing so that dirt can be thoroughly and swiftly flushed out, preventing chunks build up.
08. Each back-flushing operation requires only 5 minutes to complete. Fixed daily back-flushing will further help to reduce the growth of pathogens and parasites at the same time. The fishes will no longer have to be harmed by their excreta.
09. Maintenance is simple, just requiring regular daily back-flushing, followed by washing the sand chamber at every 2 months. And replenish some 3DM filter sand which may be lost during back-flushing. It is time saving, reduces work and save costs.
10. No emission of noise, the operation is silent, long service life.
11. The operation is very simple, very easy for beginners to master.
12. Easy to install, it can be easily incorporated into the user's original filtration system.

3DM BB- Mech Chamber With Stirrer (\varnothing 60, 75, 90, 105cm)

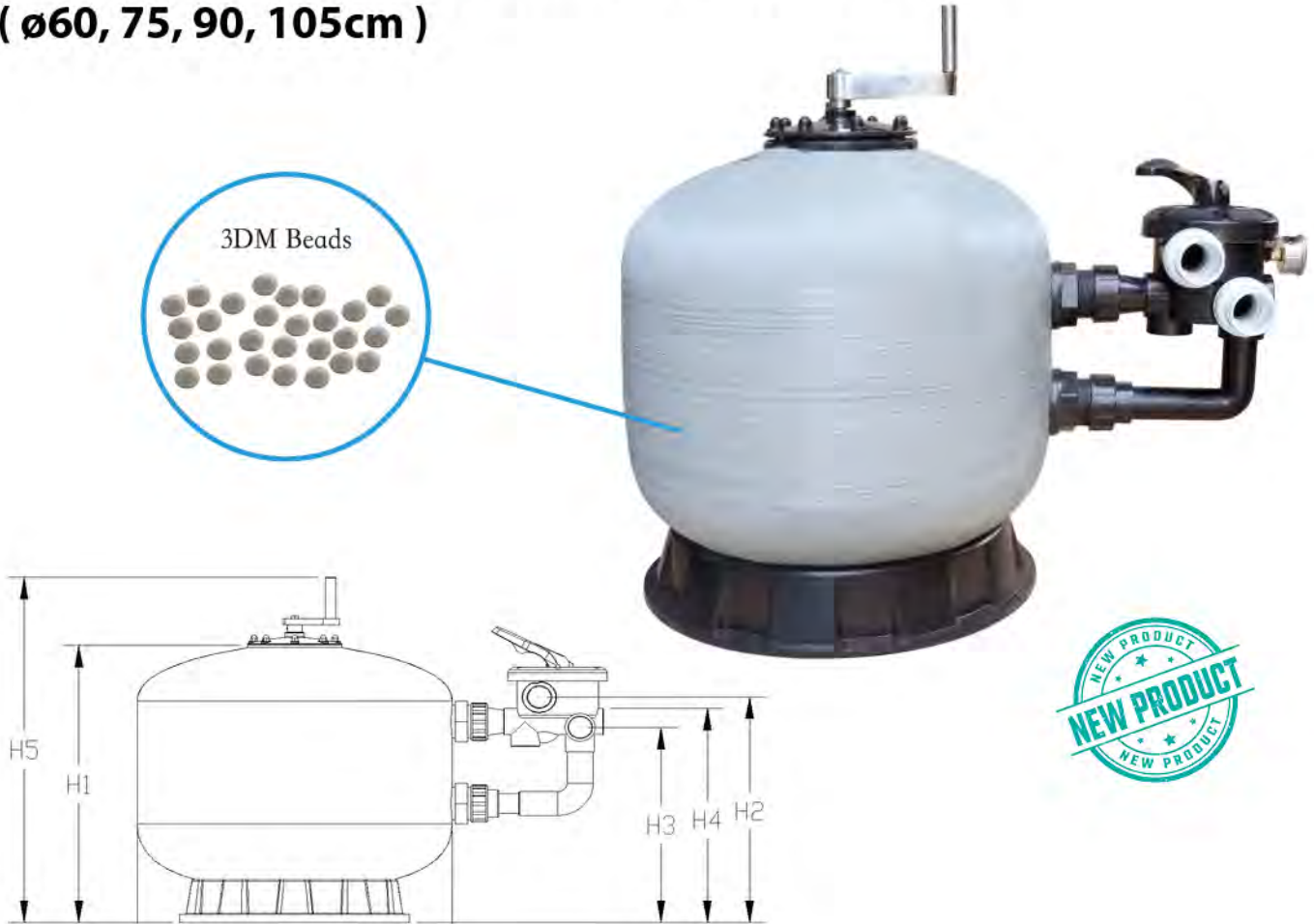

Code	EF0180	EF0181	EF0182	EF0183
Model	BB Mech Stirrer 600	BB Mech Stirrer 750	BB Mech Stirrer 900	BB Mech Stirrer 1050
Main Body Diameter (mm)	600	750	900	1050
Chamber Volume (L)	115	222	380	525
Bio Bead Volume (L)	88	184	328	424
Piping Diameter (mm / inch)	50 / 1.5" (48)	63 / 2" (60)	63 / 2" (60)	63 / 2" (60)
Recommended Flow Rate L / H	10000 - 20000	10000 - 30000	20000 - 50000	20000 - 50000
Recommended for Water Volume	<20000L	<30000L	<40000L	<50000L
Body Height (H1)	630	765	970	1075
Inlet Height (H2)	485	600	700	765
Outlet Height (H3)	430	525	625	690
Waste Outlet Height (H4)	425	515	615	680
Total Height (H5)	810	945	1150	1255

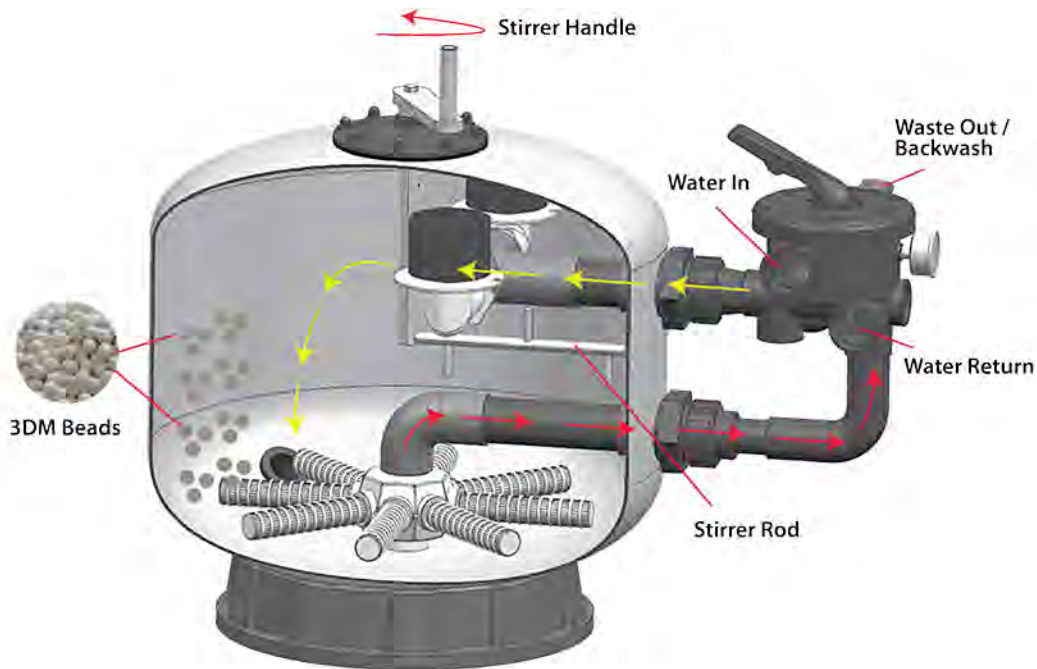
Illustration :**Product Features :**

01. Mechanical Filtration system with high-efficiency filter media, multi-directional valve lever for simple operation, high-strength fiber - glass material production. Built-in Stirrer design that can be manually operated to loosen the filter media during backwashing.
02. Unique 3DM high porosity, ultra-light round bead type filter sand, mechanical and biological filtration all-in-one, it traps dirt between sand beads and with the special biofilm on the surface, it can further capture tiny micro dirt. At the same time, it has the unique function of natural dirt reduction.
03. 3DM porous ultra-light round bead type filter sand, requires lower pressure power to operate, this it is energy saving, and protects the environment.
04. Special 3DM porous ultra-light round bead type filter sand has a good biological function and will not cause dead spots in the sand chamber. It has great inner water circulation and does not produce a bad odor. There is essentially no B.O.D, C.O.D and hydrogen sulfide present.
05. Pressured filtration flow design is many times more effective than conventional "flow through" filter sump with filter sponge and filter brushes.
06. Compact small size, it can easily replace traditional filter sump, it saves space and reduces the cost of sump construction greatly. With the modular based system, it can be added at any time according to the needs of the user and the number of fish, thus solving the troubles for the industry players and hobbyists.
07. Comes with a manual stirrer handle, the user can turn the stirrer handle while performing back-flushing so that dirt can be thoroughly and swiftly flushed out, preventing chunks build-up.
08. Each back-flushing operation requires only 5 minutes to complete. Fixed daily backflushing will further help to reduce the growth of pathogens and parasites at the same time. The fishes will no longer have to be harmed by their excreta.
09. Maintenance is simple, just requiring regular daily backflushing, followed by washing the sand chamber at every 2 months. And replenish some 3DM filter sand which may be lost during backflushing. It is time saving, reduces work and saves costs.
10. No emission of noise, the operation is silent, long service life.
11. The operation is very simple, very easy for beginners to master.
12. Easy to install, it can be easily incorporated into the user's original filtration system.

3DM Bio - Chamber (ϕ 45, 60, 75, 90, 105cm)

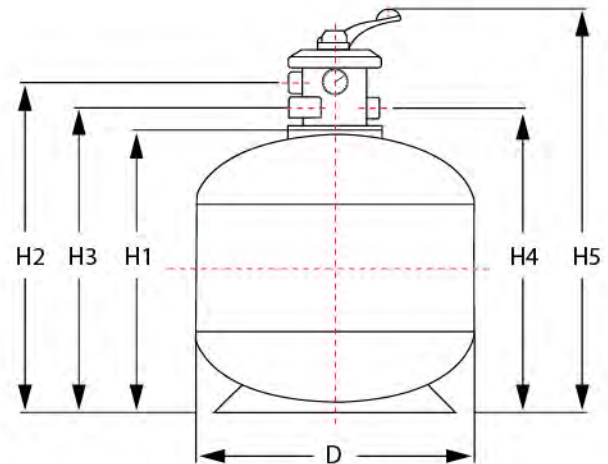

Code	EF140	EF141	EF142	EF146	EF143
Model	Bio-Chamber 450	Bio-Chamber 600	Bio-Chamber 750	Bio-Chamber 900	Bio-Chamber 1050
Main Body Diameter (mm)	450	600	750	900	1050
Chamber Volume (L)	48	115	222	380	525
Bio Bead Volume (L)	46	110	215	375	515
Piping Diameter (mm / inch)	48 (50) / 1.5	48 (50) / 1.5	60 (63) / 2	60 (63) / 2	60 (63) / 2
Recommended Flow Rate L / H	2000 - 5000	5000 - 15000	5000 - 20000	10000 - 30000	10000 - 30000
Base on 3% Medium Volume against water Volume	<1500L	<3500L	<7000L	<12000L	<17000L
Base on 5% Medium Volume against water Volume	<1000L	<2200L	<4500L	<7500L	<10500L
Base on 10% Medium Volume against water Volume	<500L	<1100L	<2250L	<3500L	<5250L
Body Height (H1)	485	620	765	900	1065
Inlet Height (H2)	599	744	903	1038	1203
Outlet Height (H3)	535	680	829	964	1129
Waste Outlet Height (H4)	535	680	829	964	1129
Total Height (H5)	740	885	1080	1215	1380

OF® 3DM Pro Filter Medium provides high surface area for beneficial bacteria which helps break-down toxic wastes like Ammonia and Nitrites biologically.



3DM Tetris

OF® 3DM Pro-Filter Medium is a revolutionary mineral based beneficial-bacteria medium that incorporates the most advanced heating and multi-staged manufacturing techniques and technology to create this super macro-porous and tough biological filter medium. It's recommended for aquarist seeking the ultimate aquarium biological filter medium.



pH Neutral,
safe for all fishes



Natural
micro-flaking
of Bio-Membrane
reduces clogging



Improves
water quality



Porosity up to
75% and Water
Absorptivity
up to 78%



High effective
surface area
(Up to 2550m²)

Magnified view of exploded continuous cavities and interlinked micro-tunnels.

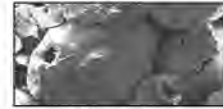

Electronic image



Electronic image



x 35 times

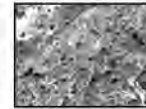

x 100 times



x 200 times

Different cavity sizes



0.1 - 3mm large cavity



10 - 500um medium cavity



0.1 - 10um micro cavity

Product Features :

01. Automatic System with high-efficiency filtration, multi-directional valve lever for simple and easy operation, high-strength fiber-glass material production.
02. Unique 3DM High porosity, ultra-light weight and porous cavity biological filter media, providing unlimited growth and high-quality growing surface area for beneficial bacteria, it has 5-15 times effective surface area of other filter media, ensuring sufficient beneficial bacteria group to achieve biological purification of water.
03. Special shape and design ensure that water can flow more evenly through each filter media, and ensure that some waste can pass through the biological system without causing blockage, greatly reducing the frequency of maintenance, thus saving time and trouble.
04. The round shaped bioreactor further ensures a smoother and better circulation of water, with no dead spots in the bioreactor. No odor will be produced, and no B.O.D, C.O.D, and hydrogen sulfide are produced.
05. The solid bioreactor can replace the traditional filtration bio-sump, saving expensive land space and construction cost. Moreover, this product is a modular based system, which can be added or reduced according to the needs of users, and can be shifted at any time to solve the hassle for major group of fish-loving hobbyist, which are not possible with traditional filtration systems.
06. With backwash function, when you need to clean the bio-reactor, just turn the lever to the backwash function, you can simply and effectively clean the filter media of the bio-reactor, which can be completed in a few minutes, which is very time-saving, labor-saving and water saving, and this does not dirty the surrounding and does not create bad smell.
07. It can be more effective and simple to set regular maintenance cleaning, further reducing the accumulation of waste, and indirectly reducing the growth of pathogens and parasites, so that fish will be exposed to less harm from their excreta.
08. Enclosed environment, without light exposure, is more suitable for the growth of beneficial bacteria and further improve the efficiency of the biological reactor.
09. The 3DM bioreactor does not cause significant resistance to water flow, so it saves operational energy, reduce emissions, protect the environment, and save electricity.
10. It can be easily added to any pond that lacks or have insufficient biological conditions, thus solve another big problem for fish lovers.
11. Easy and simple to install, the bioreactor can be installed in any ideal position, not necessarily at the edge of the pond, thus it is very flexible, and it is not limited to shortage of area around the pond.
12. No noise, quiet operation, long service life and low maintenance.
13. The operation is very simple and easy for beginners to master.
14. There is basically no traditional breeding phenomenon of mosquitoes, no appearance of odor, more hygiene and clean, which is a great product for fish lovers.

Hydra Ginox

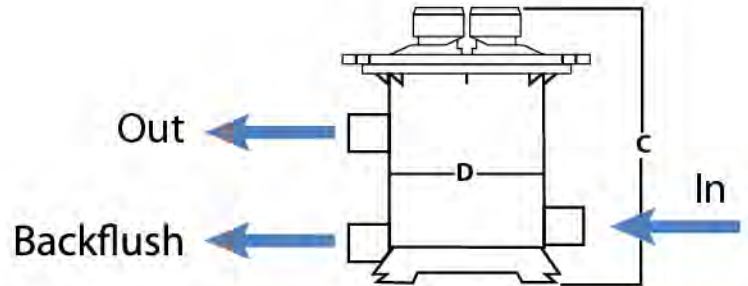
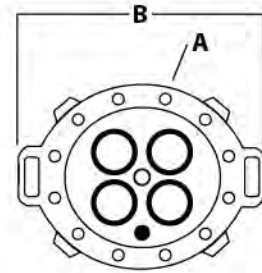

Product Features :

01. Compact and space saving design.
02. Can be conveniently installed away from the pond / aquarium.
03. Can be flexibly installed into existing filtration system.
04. Easy installation and minimum maintenance design.
05. Installation work can be performed by one person.
06. Wide model range selection for different water volume application.
07. For bigger ponds with multiple units, connect in parallel.
08. Can be installed with optional manual backflush unit.
09. Backflush once a month for 30sec.
10. Separate version available for Freshwater and Marine Application.

For Freshwater		For Marine	
Code	Specification	Code	Specification
EF153	500g / 5000L	EF159	500g / 5000L
EF154	1000g / 10000L	EF160	1000g / 10000L
EF155	1500g / 15000L	EF161	1500g / 15000L
EF156	2000g / 20000L	EF162	2000g / 20000L
EF157	2500g / 25000L	EF163	2500g / 25000L
EF158	3000g / 30000L	EF164	3000g / 30000L

Model	Cata-Pure Weight (g)	Recommended Water Volume (L)	Pipe Size	Recommended Flowrate (L / H)	Power (W)	Diameter A (mm)	Dimension B (mm)	Dimension C (mm)	Dimension D (mm)	Packaging Dimension (mm)	Nett Weight (KG)	Gross Weight (KG)	Power Input
1	500	5000	63/2"(60)	5000 - 10000	3.5	380	450	555	280	470 x 400 x 580	14.9	16.9	DC 5V 2A
2	1000	10000	63/2"(60)	10000 - 20000							15.1	17.1	DC 5V 2A
3	1500	15000	63/2"(60)	10000 - 30000							15.3	17.3	DC 5V 2A
4	2000	20000	63/2"(60)	10000 - 30000							15.5	17.5	DC 5V 2A
5	2500	25000	63/2"(60)	20000 - 40000							15.6	17.6	DC 5V 2A
6	3000	30000	63/2"(60)	20000 - 50000							15.8	17.8	DC 5V 2A

UV Radiator

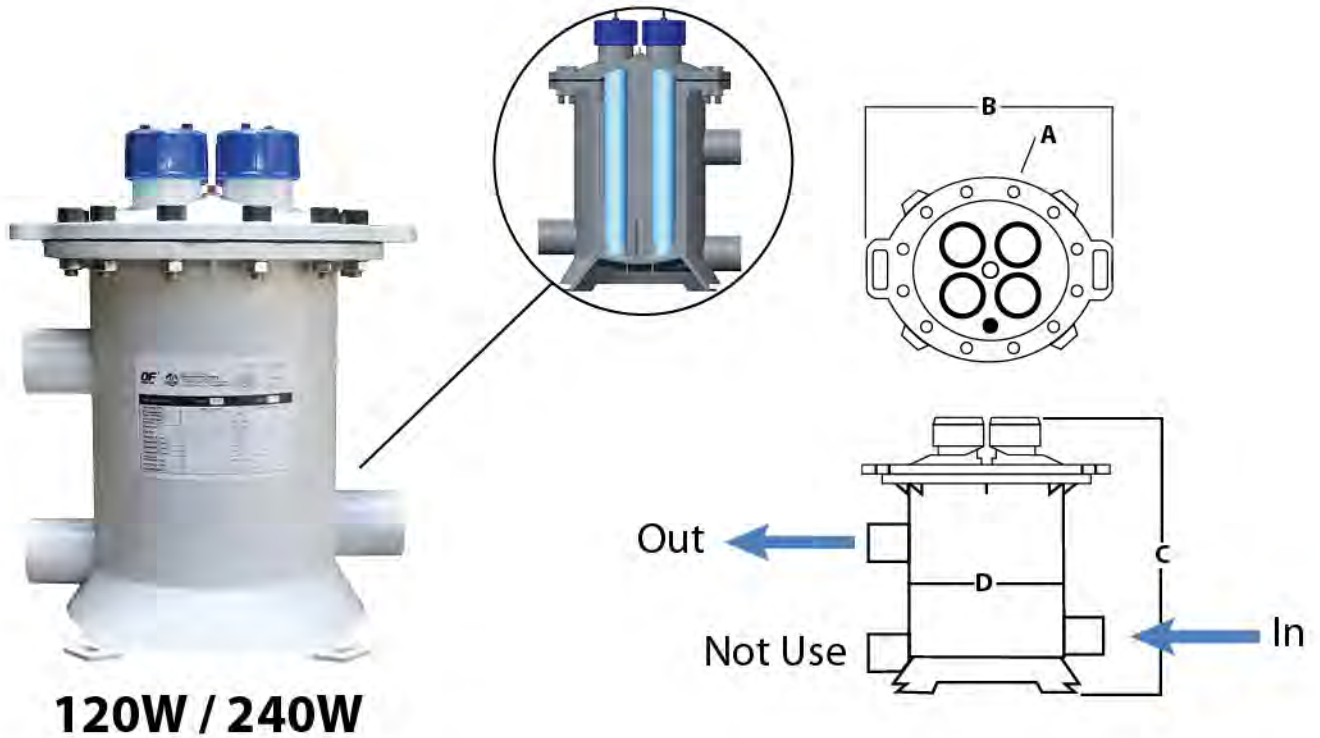

Product Features :

01. High efficiency sterilization and algae removal.
02. Compact and space saving design.
03. Can be conveniently installed away from the pond / aquarium.
04. Can be flexibly installed into existing filtration system.
05. Easy installation and minimum maintenance design.
06. Installation work can be performed by one person.
07. For larger water volume application, connect multiple units in parallel.
08. Each UV Lamp is controlled individually (4 units).
09. Check UV Lamp functionality via Light Guide (at top cover).
10. Due to natural degradation of UV light output, advise to replace UV Lamp annually to ensure maximum efficiency.

Code	UV-C Lamp (W)	Recommended Water Volume (L)	Pipe Size	Recommended Flowrate (L/H)	Diameter A (mm)	Dimension B (mm)	Dimension C (mm)	Dimension D (mm)	Packaging Dimension (mm)	Nett Weight (KG)	Gross Weight (KG)	Power Input
UV023	240W (4 x 60W)	30000	63/2"(60)	5000 - 10000	380	450	571	280	490 x 470 x 615	15	16.5	AC 100 - 240V
UV028	120W (2 x 60W)											

3DM SMART INTERNAL FILTER

OF® Smart Internal Filter just got smarter with OF® 3DM Pro-Filter Medium which is a revolutionary mineral based beneficial-bacteria medium that incorporates the most advanced heating and multi-staged manufacturing techniques and technology to create this super macro-porous and tough biological filter medium.

OF® 3DM Smart Internal Filter provides both Mechanical and Biological filtration that ensures organic waste and their toxic by-product are effectively broken down and provide optimum conditions for your fishes.

* It is suitable for all tropical aquarium setup.

Features :

- Easy to use; no complicated installation required.
- Adjustable flow direction.
- Quiet and efficient.
- Adjustable flow-rate.
- Venturi Adaptor.



Code No.	Specification	Power Consumption	Max Output	Recommended Tank	Packing
IF114	3DM Smart 400	6W	400 L / H	Up to 45cm	36 pieces/carton
IF115	3DM Smart 600	7.5W	600 L / H	Up to 60cm	24 pieces/carton
IF116	3DM Smart 800	10W	800 L / H	Up to 75cm	24 pieces/carton
IF117	3DM Smart 1000	15W	1000 L / H	Up to 90cm	16 pieces/carton
IF118	3DM Smart 1200	18W	1200 L / H	Up to 120cm	12 pieces/carton
IF119	3DM Smart 1500	27W	1500 L / H	120cm and above	12 pieces/carton

3DM SMART RINGS CARTRIDGE



Code No.	Specification	Packing
RP529A	For 3DM Smart 400	24 pieces/carton
RP529B	For 3DM Smart 600 & 800	24 pieces/carton
RP529C	For 3DM Smart 1000	24 pieces/carton
RP529D	For 3DM Smart 1200 & 1500	24 pieces/carton

SMART INTERNAL FILTER

- Simple
- Quiet
- Efficient

Utilizing a specially designed core, the SMART Internal Filter cleans, detoxifies and treats the water with 3 filtration stages – Mechanical, Biological and Chemical filtration. The main bio-foam compartment combined with the chemical filtration shaft ensures organic waste and their toxic by-products are effectively broken down, providing optimum conditions for your fishes.

* It is suitable for all tropical aquarium setup.

Features:

- Adjustable flow direction
- Adjustable flow-rate
- Easy to use; no complicated installation required
- Quiet and efficient
- 3 Stage Filtration for maximized cleaning efficiency



Code No	Description	Specification	Power Consumption	Packing
IF093	Smart Internal Filter 400	400 L/H	6 W	36 pieces/carton
IF094	Smart Internal Filter 600	600 L/H	7.5 W	24 pieces/carton
IF095	Smart Internal Filter 800	800 L/H	10 W	24 pieces/carton
IF096	Smart Internal Filter 1000	1000 L/H	15 W	16 pieces/carton
IF097	Smart Internal Filter 1200	1200 L/H	18 W	12 pieces/carton
IF098	Smart Internal Filter 1500	1500 L/H	27 W	12 pieces/carton

SMART BIO FOAM / SMART ACTIVATED CARBON WITH ZEOLITE CARTRIDGE

SMART Filter inserts allows for quick and easy replacement of filter mediums in your SMART FILTER.



Code No	Description	Specification	Packing
RP197A	Smart Bio-Foam	For Smart Underwater Filter 400	48 pieces/carton
RP197B	Smart Bio-Foam	For Smart Underwater Filter 600/800	48 pieces/carton
RP197C	Smart Bio-Foam	For Smart Underwater Filter 1000	48 pieces/carton
RP197D	Smart Bio-Foam	For Smart Underwater Filter 1200/1500	48 pieces/carton
RP198A	Smart Activated Carbon with Zeolite Cartridge	For Smart Underwater Filter 400	48 pieces/carton
RP198B	Smart Activated Carbon with Zeolite Cartridge	For Smart Underwater Filter 600/800	48 pieces/carton
RP198C	Smart Activated Carbon with Zeolite Cartridge	For Smart Underwater Filter 1000	48 pieces/carton
RP198D	Smart Activated Carbon with Zeolite Cartridge	For Smart Underwater Filter 1200/1500	48 pieces/carton

SURFCLEAR SURFACE SKIMMER

- Effective Surface Skimming
- Safe for small Shrimps & Fishes
- Easy Cleaning
- Adjustable Flow Rate
- Adaptive to Water Level Changes
- Multi-Directional Flow Outlet

The aquarium water surface may develop unsightly oil slicks due to fish waste, uneaten feeds and dirty air. Oil slicks reduce the amount of gas exchange at the water surface and the air above, which will reduce the amount of oxygen in the water. Oil slicks also cause reductions in light penetration into the water. The OF Surf Clear Aquatic Surface Skimmer can effectively remove any oil slicks and keep the water surface clean and clear.



OF® SURFCLEAR Components:

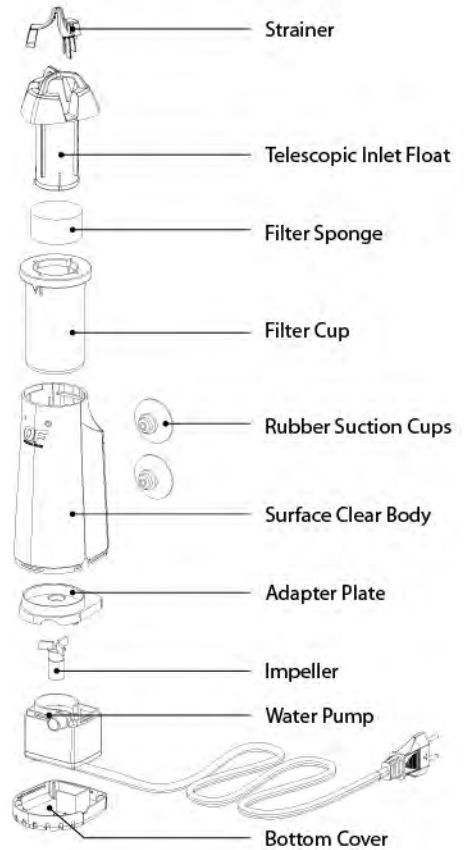

Features:

<p>Effective Surface Skimming</p>	<p>Easy Cleaning</p>		
<p>Safe for Small Shrimps & Fishes</p>	<p>Adjustable Flow Rate</p>	<p>Adaptive to Water Level Changes</p>	<p>Multi-Direction Flow Outlet</p>

Code No	Specification	Max Flow Rates	Power Consumption	Packing
SM042	4.5 x 6 x 13.5cm	50-200 L/H	3 W	48 pieces/carton

RAPTOR

Submersible Filter

Features

- Mechanical & Biological Filtration. Special biological coarse black filter sponge (ideal for nurturing beneficial bacteria)
- Easy to upgrade. Capable of adding extra filter cartridge for better performance.
- Multi-use. Can be used as internal filter or powerhead.
- Easy to use. Removable parts for easy maintenance.
- Reliable, Powerful and Silent. For freshwater and marine.



Durable



Silent



Energy Saving



Strong Performance



Applications

- Improves water circulation within main tank to minimize dead spots within the tank and enhances aeration.
- Creates water current for fishes that require stronger water flow.
- Can be used together with under-gravel filters and for water transfer.
- For freshwater and marine aquarium, terrarium and small ponds.

Code No.	Specification	Max Flow (L/H)	Max Height (M)	Power Consumption	Packing
IF108	Raptor F-3000	300	0.65	1.8W	96 pieces/carton
IF109	Raptor F-7500	750	0.85	6.0W	48 pieces/carton
IF110	Raptor F-9500	950	1.20	10.0W	48 pieces/carton
IF111	Raptor F-12000	1200	1.40	15.0W	36 pieces/carton
IF112	Raptor F-16000	1600	1.85	22.0W	36 pieces/carton
IF113	Raptor F-24000	2400	2.20	25.0W	24 pieces/carton

SUPERBOY G2 - 600

- Aqua Zonic Super Boy Generation II is a high quality aquarium filtering system using special selected material for longer life span and stable performance
- Easy to install & minimum maintenance
- One of the world leading top quality filter



Code No	Description	Specification	Power Consumption	Packing
TF042	Top Filter 600	1080 L/H	15.5 W	6 pieces/carton

SUPERBOY G2 - MOTOR & PARTS

- Suitable For Majority Top Filter
- Flow Rate 1080L / H



Code No	Description	Specification	Power Consumption	Packing
TF043	Motor 600	1080 L/H	15.5 W	24 pieces/carton

BLACK KNIGHT TOP FILTER

- Chemically
- Circulation
- Oxygen Supply
- Mechanical, Biological & Chemical filtration in order to obtain the ultimate results
- Flexibility of selecting own filter medium to suit individual needs
- Strong output to ensure full recycling of aquarium water through filter
- Special design, easy to use, install & maintain
- Mechanically
- Biologically



Code No	Description	Max. Flow Rate	Volume H/Max	Power (W)	Filter Tray Volume	Packing
TF047	Black Knight-1	800 L/H	1.4 M	8 W	1.9 L	20 pieces/carton
TF048	Black Knight-2	1000 L/H	1.6 M	12 W	2.3 L	20 pieces/carton
TF049	Black Knight-3	1100 L/H	1.7 M	15 W	3.6 L	20 pieces/carton
TF050	Black Knight-4	1800 L/H	1.8 M	18 W	4.9 L	12 pieces/carton

AQUA PRO EXTERNAL CANISTER FILTER

Superior performance and enhanced reliability. Designed for all dedicated aquarists.

- Powerful and silent operation
- Smart Start Pump for easy set-up
- Versatile Hose Adaptor inlet & outlet valve
- Individual filter basket for maximized filtration efficiency
- UV Sterilizer to reduce algae & harmful pathogens
(Apply only to filter with UV)



Included Accessories

1. Hose Adaptor Head
2. Hose Adaptor Clip
3. Clip
4. Pump Head
5. Filter Basket Cover
6. Filter Basket-4
7. Filter Basket-3
8. Filter Basket-2
9. Filter Basket-1
10. Clip
11. Filter Body
12. Inlet Hose
13. Outlet Hose
14. Rain Bar Set
15. Outlet Pipe Set
16. UV Lamp
(Aqua Pro UV Only)

Code No	Description	Max. Flow Rate	Power Consumption	Packing
EF102	Aqua PRO 800	800 L/H	18 W	Individual
EF103	Aqua PRO 1200	1200 L/H	25 W	Individual
EF108	Aqua PRO 1200-UV	1200 L/H	25 W	Individual
EF104	Aqua PRO 1800	1800 L/H	45 W	Individual
EF106	Aqua PRO 1800-UV	1800 L/H	45 W	Individual
EF105	Aqua PRO 2200	2200 L/H	60 W	Individual
EF107	Aqua PRO 2200-UV	2200 L/H	60 W	Individual

AQUA PRO FILTER MEDIUM

- The most complete and sophisticated range of Filter Medias.
- Proven highly effective for mechanical, biological and chemical filtration.
- Product manufactured under stringent quality control and production.
- Extensive range for mix and match usage.
- Ultimate solution for filter media usage.



Code No	Description	Specification	Packing
FM158	Pro Activated Carbon	400g	36 pieces/carton
FM159	Pro Activated Ceramic Ring	500g	36 pieces/carton
FM160	Pro Bio Wool-White	For Aqua Pro 800/1200/1200UV-2pcs	36 pieces/carton
FM161	Pro Bio Foam-Black	For Aqua Pro 800/1200/1200UV-2pcs	36 pieces/carton
FM162	Pro Bio Foam-Blue	For Aqua Pro 800/1200/1200UV-2pcs	36 pieces/carton
FM163	Pro Bio Wool-White	For Aqua Pro 1800/1800UV/2200/2200UV-2pcs	24 pieces/carton
FM164	Pro Bio Foam-Black	For Aqua Pro 1800/1800UV/2200/2200UV-2pcs	24 pieces/carton
FM165	Pro Bio Foam-Blue	For Aqua Pro 1800/1800UV/2200/2200UV-2pcs	24 pieces/carton

SUPER BIO-FOAM FILTER / SPARE SPONGE

Innovative Bio-Foam filter to provide the best filtration for small tropical fish tank or breeding tank.

- Bio-Foam is able to cater for mechanical and biological filtration effect
- Can be used for breeding tanks or / and used as an efficient secondary filter
- The whole Bio-Foam area is efficiently used as a filter. No dead spots present
- Can be used on different filtration installations



Code No	Specification	Packing
BFBABY	For Tank Below 40L	200 pieces/carton
BF1	For Tank Below 100L	80 pieces/carton
BF2	For Tank Below 200L	60 pieces/carton
BF4	For Tank Below 380L	45 pieces/carton
BFJJUMBO	For Tank Below 680L	24 pieces/carton

Code No	Specification	Packing
AW106	For BF1	50 pieces/carton
AW107	For BF2	50 pieces/carton
AW108	For BF4	50 pieces/carton
AW118	For BFJJUMBO	50 pieces/carton

SUPER FASTERN BIO-FOAM FILTER / SPARE SPONGE

Special designed Bio-Foam filter mainly for Discus, small tropical fishes or fry tanks.

Multi-layered to give the best possible filtration and yet gentle enough not to create too much turbulence.

- Unique break-thru Foam filtering concept with multi-layering Bio-Foam that provides the largest surface area for beneficial bacterial colonization
- Air diffusing chamber produces fine gentle bubbles to increase oxygen solubility in the water. Gentle enough for fish fry tanks
- Easy to maintain and clean. Bio-Foam can be removed, rinsed and re-used



Code No	Specification	Packing
FBFBABY	For Tank Below 40L	180 pieces/carton
FBF1	For Tank Below 100L	56 pieces/carton
FBF2	For Tank Below 200L	40 pieces/carton
FBF3	For Tank Below 250L	20 pieces/carton

Code No	Specification	Packing
AW115	For FBF1	50 pieces/carton
AW116	For FBF2	50 pieces/carton
AW117	For FBF3	50 pieces/carton

ULTRA SLIM HANG ON FILTER

- Easy restart without adding water
- High efficient filtration
- Effectively skim away surface oil film caused by bio waste
- Special cascade flow design improves dissolved oxygen level
- Quiet operation
- Ultra slim compact design
- Adjustable flow regulating valve to achieve optimal flow rate



EF118

EF109

EF110

EF111

Code No	Description	Flow Rates	Power Consumption	Packing
EF118	Ultra Slim Hang On Filter-US-BABY	180 L/H	3 W	36 pieces/carton
EF109	Ultra Slim Hang On Filter-US-01	200 L/H	3.5 W	36 pieces/carton
EF110	Ultra Slim Hang On Filter-US-02	260 L/H	4.2 W	24 pieces/carton
EF111	Ultra Slim Hang On Filter-US-03	300 L/H	4.8 W	18 pieces/carton

REPLACEMENT FILTER PAD

- Effectively filter away bio wastes
- Removes stain water, fishy odour
- Bio toxic thus enhancing superior water quality

* Suitable for Ultra Slim Hang On Filter (US-01, US-02, US-03)



FM179
Bio-Wool with
Activated Carbon



FM180
Bio-Wool Only



Code No	Specification	Packing
FM179	Bio-Wool with Activated Carbon	36 pieces/carton
FM180	Bio-Wool Only	36 pieces/carton

MULTI-LAYER CORNER FILTER

- An easy and efficient way to increase oxygen supply
- Multi-layered compartments designed for ease of maintenance
- Wide range of application on different filtration installations



Code No	Specification	Packing
AF073	For Tank Below 40L	80 pieces/carton

CRYSTAL HANG-ON FILTER / HANG-ON FILTER 2 & 3-G2

- Easy setup with flow rate adjustable
- Mini compact filter with capable bio-filtering result
- Long lasting and durable powerhead
- Fit for use for any small sized aquarium
- Self priming capability (in case of power cut) if water level is at substantial level
- Made with clear see through material for easy supervision



EF075



EF087

EF086

Code No	Description	Specification	Power Consumption	Packing
EF075	Crystal Hang-On Filter 1	120-150 L/H	3.5 W	60 pieces/carton
EF086	Crystal Hang-On Filter 2-G2	500 L/H	4.5 W	36 pieces/carton
EF087	Crystal Hang-On Filter 3-G2	680 L/H	6.5 W	24 pieces/carton

NANOSKIM PROTEIN SKIMMER

- Compact Design • For aquariums up to 60cm • Easy Maintenance
- Lime Wood Air Stone • Removable Collection Cup
- Removes organic waste compounds efficiently
- Can be installed in aquarium or filter compartment

OF NANOSKIM is designed for easy removal of organic waste compounds from your marine aquarium. Fine bubbles that are created by the air stone traps dissolved organic waste compounds and form a dense foam at the water surface. The constant upwards airflow forces the foam into the collection cup which can then be removed.

OF NANOSKIM effectively skims the waste materials off thus preventing bacteria from decomposing these organic compounds to nitrate and phosphate. It also helps to reduce the amount of harmful free floating bacteria.



Code No	Specification	Packing
SM041	For Tank Below 300 Litre	36 pieces/carton

MICRO

SUBMERSIBLE UV - C LAMP

with Air-Lift design

FEATURES

- Effective UV-C Sterilization Spectrum
- High Transparency Quartz Glass
- Effectively controls green water
- Comes with protective sponge shield and smart Air-Lift design
- Micro size to fit into small tanks and filter compartments

INTRODUCTION

The Micro Submersible UV-C Lamp is develop to effectively perform sterilization of water, killing harmful virus and bacteria pathogens and prevents green water by killing algae cells, making the water crystal clear. It comes with a sponge shield to prevent direct UV-C radiation from harming fishes. It can also function as a micro air-lift sponge filter with an external air pump. This product is suitable for small aquarium tanks (<150L water) and also for terrarium. Its micro size is also possible to be inserted into the filter compartments of suitable size hang-on filters and overhead filters.



PRODUCT DIMENSION

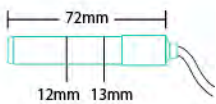

Micro Submersible UV-C Lamp

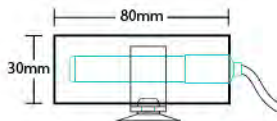

Micro Submersible UV-C Lamp with Sponge

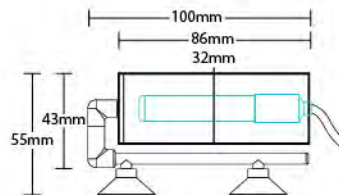

Micro Submersible UV-C Lamp with Air-Lift Design

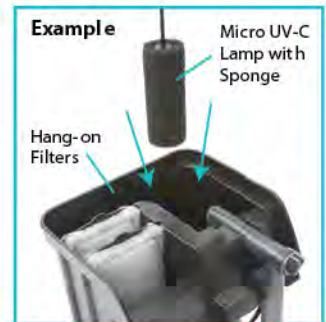

Use with suitable size hang-on filters and overhead filters

OTHER POSSIBLE APPLICATIONS IN SUITABLE SIZE FILTER COMPARTMENT & TERRARIUM



Back Filter



Hang-On Filter



Top Filter



Terrarium

Code No

UV-C Lamp Power

Power Adapter Input

Power Adapter Output

Packing

UV029

3W

100-240VAC

DC 5V 1000mA

24 pieces/carton

SMART-UVC INTERNAL FILTER

OF® SMART-UVC Internal Filter incorporates Mechanical & Biological Filtration and UV-C Sterilization to keep your water clean and your fishes healthy.

It is suitable for all tropical aquarium setup.

Features

- Keeps water clean and clear.
- Controls green water (free floating algae) without chemical usage.
- Germicidal UV-C Bulb is effective in disease prevention by eliminating harmful floating bacteria pathogens & fungal spores.
- Easy to use; no complicated installation required.
- Adjustable water flow direction.
- Adjustable water flow-rate.
- Quiet and efficient.
- 1 year warranty excluding UV Lamp.

Installation

1. Check that UV and UV Glass Cover are not cracked.
2. Filling your aquarium to your preferred water level before installation will give you a better indication of where to position the unit.
3. Once the position is determined, use suction cups to secure the unit to the inner glass surface of your aquarium.
4. Plug in the power cord; please create a drip loop to prevent water that is running down the power cable from reaching the power plug.
5. Ensure that the appliance is properly secure before turning the power on.



BEFORE



AFTER



GERMICIDAL GRADE UV-C

Eliminates Free Floating Algae and Harmful Bacteria Pathogens



280 - 500 HIGH FLOWRATE

Adjustable Flowrate for Different Requirements



3 STAGE FILTRATION

Helps Maintain Clean and Clear Water

Code No.	Description	Flow Rate (L/H)	Pump Power Consumption	UV-C Intensity ($\mu\text{w}/\text{cm}^2$)	UV-C Power Consumption	Packing
IF106	Internal Filter 5W	280 - 500	7W	25000	5W	12 pieces/carton
IF107	Internal Filter 7W	280 - 500	7W	30000	7W	12 pieces/carton
IF0125	Internal Filter 9W	1000	15W	32000	9W	12 pieces/carton
IF0126	Internal Filter 13W	1500	27W	33000	13W	12 pieces/carton
LT396	Replacement Bulb 5W	-	-	-	-	96 pieces/carton
LT397	Replacement Bulb 7W	-	-	-	-	96 pieces/carton
LT0423	Replacement Bulb 9W	-	-	-	-	25 pieces/carton
LT0424	Replacement Bulb 13W	-	-	-	-	25 pieces/carton

ANCHORAGE SUBMERSIBLE

High Power UV Lamp

Function :

- Special Quartz Glass
- Kills Harmful Bacteria Pathogens
- More Efficient & High Power
- Controls Green Water
- Self-Sinking



Introduction :

Aqua Zonic Anchorage Submersible High Power UV Lamp is specially made for underwater Sterilization needs and comes in different sizes to suit all purposes. Made with high quality material and total waterproofed, well-designed self-sinking anchor weight allows the UV Lamp to be secure and stable in place making it low maintenance, reliable and can be used for extended period of time. UV tube is replaceable as well when the need arises.

Heavy Submersible Weight Included :



Code No.

UV021

UV022

Specification

Anchorage Submersible - 60 W

Anchorage Submersible - 95 W

Packing

6 pieces/carton

6 pieces/carton

MINI SUBMERSIBLE UV-C LAMP G3

Function :

- Effective UV-C Spectrum
- High transparency quartz glass
- Effectively control green water
- 24 hours adjustable timer
- 360° removable reflector

Introduction :

Aqua Zonic Mini Submersible UV-C Lamp G3 is developed for sterilization of water and effectively kill harmful bacteria pathogens that's available in multiple specifications. Well waterproof, high performance using high-quality quartz glass. This unit is well-designed, low maintenance, durable, safe and reliable with replaceable UV-C tube.



Code No.

UV024

UV025

UV026

UV027

Description

Mini Submersible UV-C Lamp G3 - 5W

Mini Submersible UV-C Lamp G3 - 7W

Mini Submersible UV-C Lamp G3 - 9W

Mini Submersible UV-C Lamp G3 - 11W

Specification

17.5cm

19.0cm

21.5cm

25.5cm

Packing

24 pieces/carton

24 pieces/carton

24 pieces/carton

24 pieces/carton

SUPER UNIVERSAL UV FILTER

- Extra long UV effective hours - 5000 hours
- Helps obtain and maintain optimal water quality
- Multiple fittings provided for flexibility in application
- End indicator for safe and easy checking of UV lamp
- Special Quartz glass used for maximum UV penetration and efficiency
- Clarifies water and controls algae (green water) without chemical usage
- Highly effective in disease prevention by eliminating harmful bacteria pathogens & fungal spores



Code No	Inlet & Outlet Connector-ø	Cable Length (M)	Effection Hour	For Tank/Pond Size Up To	Power Consumption	Packing
UUV2000	12/16mm or 16/22mm	5 m	5000	2000L	5 W	12 pieces/carton
UUV9000	12/16mm or 16/22mm	5 m	5000	9000L	9 W	12 pieces/carton
UUV10000	12/16mm or 16/22mm	5 m	5000	10000L	11 W	12 pieces/carton
UUV12000	12/16mm or 16/22mm	5 m	5000	12000L	13 W	12 pieces/carton
UUV20000	12/16mm or 16/22mm	5 m	5000	20000L	18 W	12 pieces/carton
UUV35000	12/16mm or 16/22mm	5 m	5000	35000L	36 W	6 pieces/carton
UUV48000	12/16mm or 16/22mm	5 m	5000	48000L	55 W	6 pieces/carton

UV LAMP 5000

- Highly effective in disease prevention by eliminating harmful bacteria pathogens & fungal spores
- Extra long UV effective hours: 5000 hours
- Compatible with other UV Filters



Code No	Description	Specification	Packing
LT196	G-23	5 W (2000L)	24 pieces/carton
LT197	G-23	9 W (9000L)	24 pieces/carton
LT198	G-23	11 W (10000L)	24 pieces/carton
LT199	2G-11	13 W (12000L)	24 pieces/carton
LT200	2G-11	18 W (20000L)	12 pieces/carton
LT201	2G-11	36 W (35000L)	12 pieces/carton
LT202	2G-11	55 W (48000L)	6 pieces/carton



MINI SUBMERSIBLE UV-C LAMP

- Controls Green Water
- More Compact
- Special Quartz Glass
- Kills Harmful Bacteria Pathogens!

Function:

- Clears water and controls green water (free floating algae without chemical usage)
- Effectively in disease prevention by eliminating harmful bacteria pathogens & fungal spores
- Clear quartz glass for better efficiency
- Safe for aquarium livestock
- Waterproofed and submersible in water
- Replaceable UV-C tube



Before



After

UV009

UV010

UV011

UV012



Code No.

- UV009
- UV010
- UV011
- UV012

Description

- Mini Submersible UV-C Lamp
- Mini Submersible UV-C Lamp
- Mini Submersible UV-C Lamp
- Mini Submersible UV-C Lamp

Specification

- 5W / 17.5cm
- 7W / 19cm
- 9W / 21.5cm
- 11W / 25.5cm

Packing

- 24 pieces/carton
- 24 pieces/carton
- 24 pieces/carton
- 24 pieces/carton

MINI SUBMERSIBLE UV-C LAMP SHADE

- Minimizes direct eye contact with UV-C Ray
- Blocks and protects your livestock and beneficial bacteria from UV-C Ray.

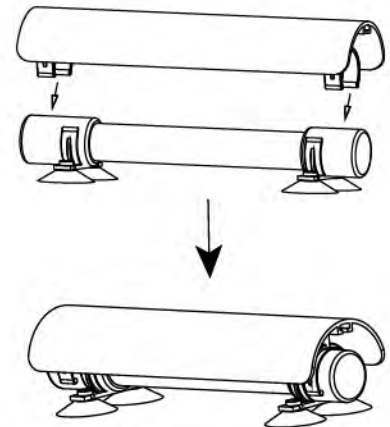

Code No.

- RP515
- RP516

Description

- Mini Submersible UV-C Lamp Shade
- Mini Submersible UV-C Lamp Shade

Specification

- for 5W / 7W
- for 9W / 11W

Packing

- 60 pieces/carton
- 60 pieces/carton

SUBMERSIBLE UV LAMP-G2-i

- Special Quartz Glass
- Improved Version
- More Efficient
- More Compact
- Internal Ballast

Aqua Zonic Submersible UV Lamp G2-i is specially made for underwater sterilization needs and comes in different sizes to suit all purposes. Made with high quality material and total waterproofed, this product is well-designed, low maintenance, reliable and can be used for extended period of time. UV tube is replaceable as well when the need arises.



Code No	Description	Specification	Packing
UV005	Submersible UV Lamp-G2-i	15 W / 53.5 cm	12 pieces/carton
UV006	Submersible UV Lamp-G2-i	20 W / 58.5 cm	12 pieces/carton
UV007	Submersible UV Lamp-G2-i	30 W / 81.5 cm	12 pieces/carton
UV008	Submersible UV Lamp-G2-i	40 W / 110.5 cm	12 pieces/carton

SUBMERSIBLE UV LAMP-G2

- Special Quartz Glass
- Improved Version
- More Efficient
- More Compact

Aqua Zonic Submersible UV Lamp G2 is specially made for underwater sterilization needs and comes in different sizes to suit all purposes. Made with high quality material and total waterproofed, this product is well-designed, low maintenance, reliable and can be used for extended period of time. UV tube is replaceable as well when the need arises.



Code No	Description	Specification	Packing
UV001	Submersible UV Lamp-G2	15 W / 35 cm	12 pieces/carton
UV002	Submersible UV Lamp-G2	20 W / 40 cm	12 pieces/carton
UV003	Submersible UV Lamp-G2	30 W / 59.5 cm	12 pieces/carton
UV004	Submersible UV Lamp-G2	40 W / 88.5 cm	12 pieces/carton

UV LAMP-G2

- Improved Version
- More Efficient
- More Compact
- Controls Algae, Bacteria, Sludge
- Helps protect fish against sickness
- Improves water quality
- Safe and good for your plants and fish



Code No	Description	Specification	Packing
LT249	UV Lamp-G2	15 W / 31.1 cm (with pin)	12 pieces/carton
LT250	UV Lamp-G2	20 W / 36.4 cm (with pin)	12 pieces/carton
LT251	UV Lamp-G2	30 W / 55.8 cm (with pin)	12 pieces/carton
LT252	UV Lamp-G2	40 W / 85.1 cm (with pin)	12 pieces/carton

Little Giant Amphibious Pump

FEATURES

- The pump motor is completely sealed with unique sealant that provides excellent electrical insulation.
- The hi-tech motor and distinctive housing structural design, result in a water pump that is very energy efficient and highly durable.
- Equipped with interchangeable connector parts to provide flexibility in amphibious application areas.
- Reliable, Easy Maintenance, Silent and Powerful.



Energy Saving



High Head Pressure & Flowrate



Silent Operation



APPLICATION

- Precision impeller shaft made of high density aluminum-ceramic for durable operation in freshwater and seawater applications.
- The water pump designed for both submersible and amphibious applications.
- Applicable in areas for general water pumping, improving aeration, wave-making, water filtration and water fountain ...etc.
- The water pump body casing is made of high quality durable plastics to withstand corrosion.

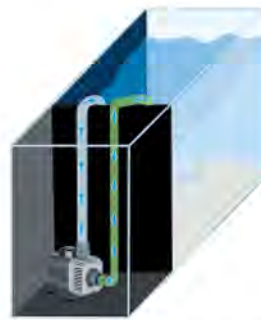

Amphibious Pump Application



Submersible Pump Application

Code No	Description	Max Output Output (L/H)	Power Consumption	Max Head (M)	Packing
WP107	Little Giant 2200	2200 L/H	40 W	2.5M	12 pieces/carton
WP108	Little Giant 2800	2800 L/H	48 W	3M	12 pieces/carton
WP109	Little Giant 3200	3200 L/H	60 W	3.5M	12 pieces/carton
WP110	Little Giant 4800	4800 L/H	90 W	4.5M	8 pieces/carton
WP111	Little Giant 5800	5800 L/H	105 W	5.5M	8 pieces/carton
WP112	Little Giant 7000	7000 L/H	125 W	5.5M	4 pieces/carton

SUPERBOY

POWERHEAD & PUMP

GII



Compact
Design



Low
Maintenance



High
Performance



Energy
Saving



Durable &
Silent

APPLICATION & FEATURE:

- Suitable for Freshwater and Saltwater aquarium.
- Suitable for terrarium and small ponds.
- Create water current for fishes that require strong water flow.
- Improve water circulation and enhances aeration.
- Compact design, durable and silent.
- High performance with low energy consumption.
- Easy to maintain.

Code No.	Specification	Max Flow (L/H)	Max Height (M)	Power Consumption	Packing
PH148	Superboy G2 800	800	1.3	15W	24 pieces/carton
PH149	Superboy G2 1300	1300	1.3	25W	24 pieces/carton
PH150	Superboy G2 1800	1800	1.5	35W	24 pieces/carton
PH151	Superboy G2 2300	2300	2.5	45W	24 pieces/carton

RAPTOR

Submersible Powerhead & Pump

Features

- Reliable, Powerful and Silent Submersible Powerhead.
- Wear-resistant Ceramic Shaft.
- Easy availability of spare parts.
- Easy to maintain.
- Freshwater and Marine.



Durable



Silent



Energy Saving



Strong Performance



Applications

- Improves water circulation within main tank to minimize dead spots within the tank and enhances aeration.
- Creates water current for fishes that require stronger water flow.
- Can be used together with under-gravel filters and for water transfer.
- For freshwater and marine aquarium, terrarium and small ponds.

Code No.	Specification	Max Flow (L/H)	Max Height (M)	Power Consumption	Packing
PH142	Raptor 3000	300	0.65	1.8W	120 pieces/carton
PH143	Raptor 7500	750	0.85	6.0W	60 pieces/carton
PH144	Raptor 9500	950	1.20	10.0W	60 pieces/carton
PH145	Raptor 12000	1200	1.40	15.0W	36 pieces/carton
PH146	Raptor 16000	1600	1.85	22.0W	36 pieces/carton
PH147	Raptor 24000	2400	2.20	25.0W	24 pieces/carton

SPARTAN

DC VARIABLE FREQUENCY PUMP

CE RoHS



DC INVERTER-TECH CORE

Reduce power consumption without sacrificing performance



ADVANCED USERS CONTROLS

- Wave Maker Mode (Sine or Pulsing Wave)
- Previous Setting Memory Function
- Variable 10 Speed Control
- 10mins Feed Mode



COMPACT SIZE

Maximize your available space



Amphibious –
Dry or Wet Mount



Freshwater
and Marine



Key Features :

Aquazonic® Spartan DC Variable Frequency Pump is a compactly designed water pump engineered to pack a punch. Its proprietary DC Inverter-Tech Core delivers strong water-flow and yet uses only a fraction of the power consumption required by conventional pumps to provide energy saving.

DC Inverter-Tech Core. Reduce your utility bill without sacrificing performance. Spartan's unique DC motor design allows it to deliver the same water flow as conventional pumps while using lesser energy consumption.

Compact Size. The Spartan's compact body allows users to maximize their available space.

Advanced User Controls. Convenience at your fingertips.

- 1) **Previous Setting Memory Function.** In the event of power failure, Spartan is capable of remembering the last settings.
- 2) **Variable 10 Speed Control.** Users get to choose their preferred flowrate from level 1 (10%) to 10 (100%).
- 3) **10mins Feed Mode.** When feed mode is activated, SPARTAN DC will be turned off and restarted automatically after 10mins. Alternatively, press the 'power' button to cancel feed mode and resume normal operation.

Adjustable Flow Rate. Provides flexibility to users who desire different flow rates for different applications. E.g. higher flow rate during the day to promote good water movement, and a lower flow rate in the night for the fishes to rest.

Intelligent Motor-Overheat Protection. Prevents the pump from overheating due to pump running without water, stalling of impeller and surge of electrical current.

Easy Maintenance. Spartan can be easily assembled and disassembled for cleaning and maintenance.

Applications :

Freshwater or marine aquarium, ponds, filtration systems, water circulation, aeration or applications that require constant and strong water flow.

*** Important: Install the appliance below or in-line with your aquarium/pond's water level.**

Flow Rate Chart :

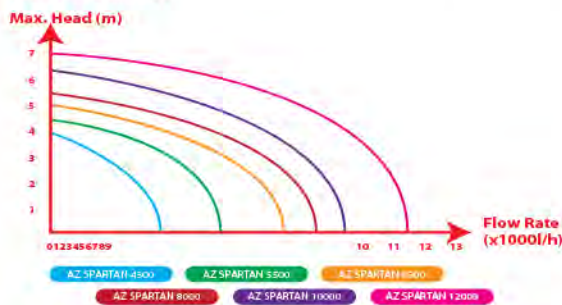

Wave Maker Mode Diagram (Sine Wave) :

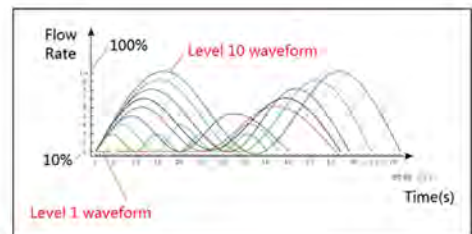

Wave Maker Mode Diagram (Pulsing Wave) :

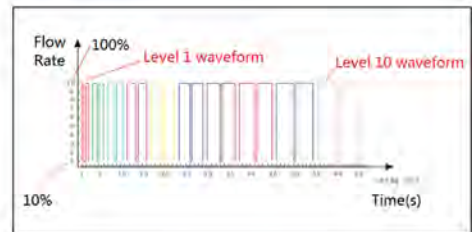

Components :

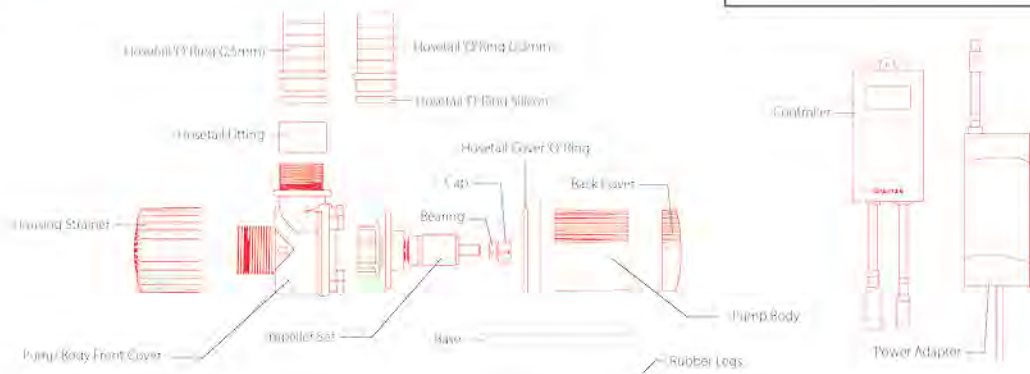

Code No.	Description	Flow Output (L/H)	Max Head	Power Consumption	Packing
WP093	Spartan DC Pump 4300	4300	4.0M	35W	6 pieces/carton
WP094	Spartan DC Pump 5500	5500	4.5M	55W	6 pieces/carton
WP095	Spartan DC Pump 6800	6800	5.0M	75W	6 pieces/carton
WP096	Spartan DC Pump 8000	8000	5.5M	85W	6 pieces/carton
WP097	Spartan DC Pump 10000	10000	6.5M	95W	6 pieces/carton
WP098	Spartan DC Pump 12000	12000	7.0M	115W	6 pieces/carton

PRIMAL

SUBMERSIBLE WATER PUMP



Aquazonic PRIMAL is a multi-purpose submersible pump that is designed and made to pump water that contains particles up to 5mm. The Inverter Technology allows efficient use of energy with energy savings of up to 70% while retaining strong and consistent water flow!

With
Inverter Technology
Energy Saving of up to
70%

Features

- Inverter Technology for energy savings of up to 70%
- Motor with Intelligent Overheat Protection that protects motor from damage
- Tough attrition-resistant impeller
- Multiple-sealing that increases durability
- Superior flow output and max height
- Able to pump water that contains particles up to 5mm
- Easy to use and install



Tough Attrition-Resistant Impeller



Motor with Overheat Protection



Max Height

ELECTRICITY SAVINGS



Brand X Energy Consumption (Watts)



Primal Energy Consumption (Watts)



Popular Brand X Pump



Primal

Large Flow Output & Height

Primal 9000



Outlet Included



Country	Electrical Tariff \$ / kWh*	Electrical Cost / day (other pumps 280W)	Electrical Cost / day (AZ PRIMAL 80W)	Savings per Day (\$)
Singapore	SGD 0.2241	$(280/1000) \times 24 \times 0.2241 =$ SGD 1.50	$(80/1000) \times 24 \times 0.2241 =$ SGD 0.43	1.50 - 0.43 = SGD 1.07
Malaysia	RM 0.218	$(280/1000) \times 24 \times 0.218 =$ RM 1.50	$(80/1000) \times 24 \times 0.218 =$ RM 0.42	1.50 - 0.42 = RM 1.08
Thailand	Baht 1.8632	$(280/1000) \times 24 \times 1.8632 =$ Baht 12.83	$(80/1000) \times 24 \times 1.8632 =$ Baht 3.58	12.83 - 3.58 = Baht 9.25
China	CNY 0.481	$(280/1000) \times 24 \times 0.481 =$ CNY 3.232	$(80/1000) \times 24 \times 0.481 =$ CNY 0.924	3.232 - 0.924 = CNY 2.308

*For illustrative purposes and subject to changes in electrical tariffs. Please check with the relevant authorities for the updated electrical tariffs.

Primal 16000



Outlet Included

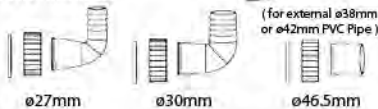

Country	Electrical Tariff \$ / kWh*	Electrical Cost / day (other pumps 700W)	Electrical Cost / day (AZ PRIMAL 140W)	Savings per Day (\$)
Singapore	SGD 0.2241	$(700/1000) \times 24 \times 0.2241 =$ SGD 3.76	$(140/1000) \times 24 \times 0.2241 =$ SGD 0.75	3.76 - 0.75 = SGD 3.01
Malaysia	RM 0.218	$(700/1000) \times 24 \times 0.218 =$ RM 3.66	$(140/1000) \times 24 \times 0.218 =$ RM 0.73	3.66 - 0.73 = RM 2.93
Thailand	Baht 1.8632	$(700/1000) \times 24 \times 1.8632 =$ Baht 31.30	$(140/1000) \times 24 \times 1.8632 =$ Baht 6.26	31.30 - 6.26 = Baht 25.04
China	CNY 0.481	$(700/1000) \times 24 \times 0.481 =$ CNY 8.08	$(140/1000) \times 24 \times 0.481 =$ CNY 1.62	8.08 - 1.62 = CNY 6.46

*For illustrative purposes and subject to changes in electrical tariffs. Please check with the relevant authorities for the updated electrical tariffs.

Primal 20000



Outlet Included



Country	Electrical Tariff \$ / kWh*	Electrical Cost / day (other pumps 750W)	Electrical Cost / day (AZ PRIMAL 170W)	Savings per Day (\$)
Singapore	SGD 0.2241	$(750/1000) \times 24 \times 0.2241 =$ SGD 4.03	$(170/1000) \times 24 \times 0.2241 =$ SGD 0.91	4.03 - 0.91 = SGD 3.12
Malaysia	RM 0.218	$(750/1000) \times 24 \times 0.218 =$ RM 3.92	$(170/1000) \times 24 \times 0.218 =$ RM 0.89	3.92 - 0.89 = RM 3.03
Thailand	Baht 1.8632	$(750/1000) \times 24 \times 1.8632 =$ Baht 33.54	$(170/1000) \times 24 \times 1.8632 =$ Baht 7.60	33.54 - 7.60 = Baht 25.94
China	CNY 0.481	$(750/1000) \times 24 \times 0.481 =$ CNY 8.66	$(170/1000) \times 24 \times 0.481 =$ CNY 1.96	8.66 - 1.96 = CNY 6.70

*For illustrative purposes and subject to changes in electrical tariffs. Please check with the relevant authorities for the updated electrical tariffs.

Code No	Description	Max Output Output (L/H)	Power Consumption	Max Head (M)	Packing
WP083	Primal 9000	9000 L/H	80 W	5.3M	4 pieces/carton
WP099	Primal 16000	16000 L/H	140 W	5.5M	4 pieces/carton
WP100	Primal 20000	20000 L/H	170 W	6.0M	4 pieces/carton

VORMAX WATER PUMP

STAINLESS STEEL WATER PUMP

- Heavy Duty Usage
- Large Water Volume
- Energy Saving

Features:

AZ Vormax is specially designed to pump large volumes of water with lower power consumption.

- The Intelligent Overhead Protection circuit prevents the pump from overheating due to pump running without water, stalling of impellor and surge of electrical current
- Large flow output & height
- Able to pump water that contains particles
- Strainer that removes particles >5mm for added durability
- Multiple-sealing for extra durability
- Tough stainless steel body
- Attrition-resistant impellor and shaft designed for easy replacement
- Removable base that allows the pump to be used in low water levels
- Super energy saving Inverter Technology

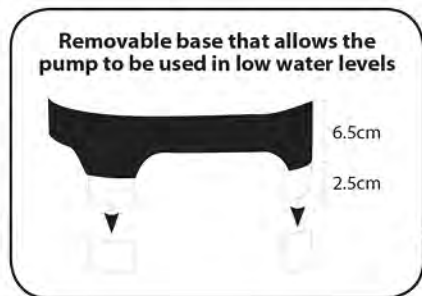

Country	Electrical Tariff \$/kWh*	Electrical Cost/day (other pumps 287W)	Electrical Cost/day (AZ Vormax 170W)	Savings per Day (\$)
Singapore	SGD\$ 0.2241	$(287/1000) \times 24 \times 0.2241 = \text{SGD } 1.54$	$(170/1000) \times 24 \times 0.2241 = \text{SGD } 0.91$	1.54 - 0.91 = SGD 0.63
Malaysia	RM\$ 0.218	$(287/1000) \times 24 \times 0.218 = \text{RM } 1.50$	$(170/1000) \times 24 \times 0.218 = \text{RM } 0.889$	1.50 - 0.889 = RM 0.61
Thailand	Baht \$1.8632	$(287/1000) \times 24 \times 1.8632 = \text{Baht } 12.83$	$(170/1000) \times 24 \times 1.8632 = \text{Baht } 7.601$	12.83 - 7.601 = Baht 5.22
China	CNY 0.6	$(287/1000) \times 24 \times 0.6 = \text{CNY } 4.132$	$(170/1000) \times 24 \times 0.6 = \text{CNY } 2.448$	4.132 - 2.448 = CNY 1.684

* For illustrative purposes and subject to changes in electrical tariffs. Please check with the relevant authorities for the updated electrical tariffs.

Low Energy Consumption (Watts)



Large Flow Output and Height

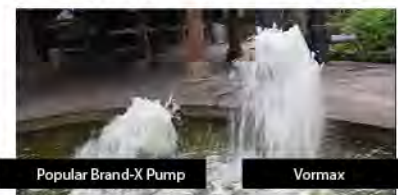

Code No	Description	Max Output Output (L/H)	Power Consumption	Max Head (M)	Packing
WP071	Vormax 15K	15000 L/H	130 W	4.5M	2 pieces/carton
WP072	Vormax 20K	20000 L/H	170 W	6M	2 pieces/carton

SUMO G2

Amphibious Pump

- Amphibious – can be dry or wet mounted
- Electronic components are encapsulated in Epoxy Resin
- Reliable and powerful
- Motor with overheat protection for more durability
- Wear-resistant Ceramic Shaft
- Silent during operation



Exploded view

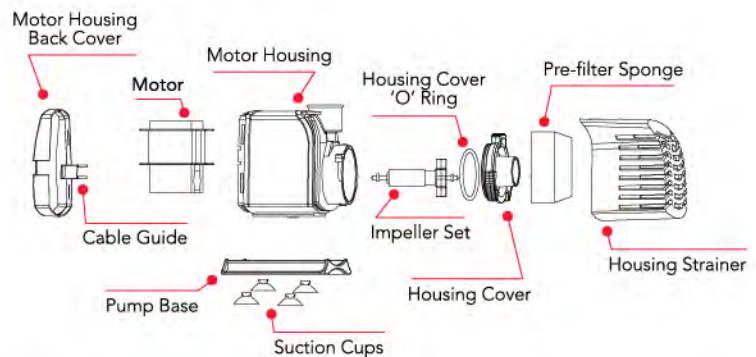
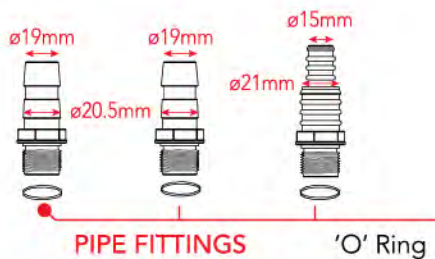

Code No	Description	Max Output (L/H)	Power Consumption	Max Head (M)	Packing
PH103	Sumo G2 - 1	1200 L/H	12 W	1.5M	24 pieces/carton
PH104	Sumo G2 - 2	1800 L/H	18 W	2.2M	12 pieces/carton
PH105	Sumo G2 - 3	3000 L/H	30 W	2.6M	12 pieces/carton
PH106	Sumo G2 - 4	5000 L/H	100W	4.5M	8 pieces/carton
PH107	Sumo G2 - 5	7500 L/H	110W	5.0M	8 pieces/carton

AMPHI

Amphibious Pump Wet or Dry Mount

AMPHI is designed and built to provide reliable pumping performance. The Inverter Technology reduces energy consumption making it suitable for all day use, giving energy savings of up to 70% while retaining strong and consistent water flow.

- **Inverter Technology.** Energy savings of up to 70% while maintaining strong flowrate.
- **Intelligent Motor-Overheat Protection.** Prevents the pump from overheating due to pump running without water, stalling of impeller and surge of electrical current.
- **Tough Attrition-Resistant Impeller.** Wear-resistant and provides better performance.
- **Replaceable Impeller.** Allows for easy replacement to maintain high performance level.

With

Inverter Technology
Energy Saving of up to
70%



Though Attrition-Resistant Impeller



Motor with Overheat Protection



Max Head 3m-5m



Freshwater and Marine Aquariums



Code No	Description	Max Output Output (L/H)	Power Consumption	Max Head (M)	Packing
WP066	Amphi 3500	3500 L/H	25 W	3.0M	4 pieces/carton
WP067	Amphi 5000	5000 L/H	45 W	3.5M	4 pieces/carton
WP068	Amphi 6500	6500 L/H	50 W	4.0M	4 pieces/carton
WP069	Amphi 8000	8000 L/H	75 W	4.5M	4 pieces/carton
WP070	Amphi 10000	10000 L/H	85 W	5.0M	4 pieces/carton

AMPHI PLUS

Variable Speed Amphibious Pump

AMPHI PLUS is a variable speed pump designed and built for reliable pumping performance. The Inverter Technology allows efficient use of energy with energy savings of up to 70% while retaining strong and consistent water flow.

- **Adjustable Flowrate.** Programmable to run at different flow-rates for wider applications, e.g. flowrate can be reduced at night to allow fish to rest, etc.
- **Advanced User Controls.** 10 speed Flowrate | 10mins Feed Mode | Previous Setting Memory | 10 Step Wave Maker Mode.
- **Inverter Technology.** Energy savings of up to 70% while maintaining strong flowrate.
- **Intelligent Motor-Overheat Protection.** Prevents the pump from overheating due to pump running without water, stalling of impeller.
- **Tough Attrition-Resistant Impeller.** Wear-resistant and provides better performance.
- **Multiple Sealing of Electronics.** Electronics are encased in epoxy-resin for added protection.

With

Inverter Technology
Energy Saving of up to
70%

Advance User Controls
Adjustable Flowrate & Feed Mode

-  **Though Attrition-Resistant Impeller**
-  **Motor with Overheat Protection**
-  **Max Head 5.5m-7m**
-  **Freshwater and Marine Aquariums with Wave Maker Mode**
-  **Variable Flowrate**
litres / hour



Code No	Description	Max Output Output (L/H)	Power Consumption	Max Head (M)	Packing
WP084	Amphi Plus 13000	13000 L/H	115 W	5.5M	3 pieces/carton
WP085	Amphi Plus 15000	15000 L/H	135 W	6.0M	3 pieces/carton
WP086	Amphi Plus 18000	18000 L/H	150 W	6.5M	3 pieces/carton
WP087	Amphi Plus 20000	20000 L/H	170 W	7.0M	3 pieces/carton

EVO SUBMERSIBLE PUMP

- Reliable, powerful & silent in operation
- Easy to maintain
- Internal usage
- Ideal for pond, salt / fresh water tank use
- Easily available of spare parts



Code No	Description	Max. Flow Rate	H/Max. (M)	Power Consumption	Packing
PH125	E-Baby	300 L/H	0.65m	4 W	72 pieces/carton
PH112	E-02	520 L/H	1m	8 W	48 pieces/carton
PH113	E-03	1300 L/H	1.2m	25 W	36 pieces/carton
PH114	E-04	2000 L/H	2m	38 W	24 pieces/carton
PH115	E-05	3000 L/H	3m	60 W	24 pieces/carton
PH116	E-06	4000 L/H	4m	85 W	12 pieces/carton
PH117	E-07	5000 L/H	5m	115 W	6 pieces/carton
PH118	E-08	6000 L/H	5.5m	135 W	6 pieces/carton

ULTRAIR

1000

HIGH OUTPUT AIR PUMP

 RoHS

Dual Output



Strong Aeration



Low Noise Level



Robust & Durable

Introduction

OF® Ultrair is a high output air pump designed to provide an optimum aeration required for your aquariums, reducing the risks of oxygen depletion. Despite its high output, the OF® Ultrair is much quieter than products of similar capacity due to the twin wall structure. OF® Ultrair is also equipped with an Air Flow Dial for you to manage the air flow required for your aquarium.

Applications

Aquariums, breeding tanks, multiple tank setups, or applications that require reliable and powerful aeration.

Accessories



Air Tube (5m)



Air Valves (2pcs)



Air Stones (2pcs)



AP099 (Standard)
Indoor Use (With Air Flow Dial)

AP100 (Splash Resistant)
Sheltered Area Use (Without Air Flow Dial)



**HIGH
OUTPUT**

Up To
1.5m Depth

Code No.	Description	Flow Rate (L/H)	Power Consumption (W)	Voltage (AC)	Packing
AP099	Standard	500 per outlet	10	220V	6 pieces/carton
AP100	Splash Resistant	500 per outlet	10	220V	6 pieces/carton

VULTRON AIR PUMP

High Efficiency Air Pump

The Vultron series high efficiency air pump provides optimum aeration to your aquarium and pond, effectively increasing dissolved oxygen level, keeping your fish healthy and lively.

- Compact design with single or twin outlets
- Rubber base helps to reduce vibration
- High propulsion for water up to 0.7m deep
- High energy efficiency
- Twin-walled body design for reduce vibration
- Increases Dissolved Oxygen (DO) level in your aquarium
- Adjustable electronic dial to control air output
- Airlines, Air Stones and Air Valve included



Code No	Description	Specification Max Output per Outlet	Power Consumption	Packing
AP092	Vultron Air Pump 1500	Single Outlet-110 L/H	2 W	48 pieces/carton
AP093	Vultron Air Pump 2000	Single Outlet-160 L/H	3 W	48 pieces/carton
AP094	Vultron Air Pump 4000	Double Outlet-170 L/H	3.3 W	24 pieces/carton
AP095	Vultron Air Pump 5000	Double Outlet-190 L/H	3.7 W	24 pieces/carton
AP096	Vultron Air Pump 7000	Double Outlet-230 L/H	5.3 W	24 pieces/carton
AS088	Vultron Air Diffuser	-	-	288 pieces/carton

SUPER Y / YY AIR PUMP

- Single Outlet H/L
- Double Outlet H/L
- High Quality
- Silent & Durable



Code No	Description	Specification	Power Consumption	Packing
AP085	Super Y Air Pump	Single Outlet - 250L/H	2.5 W	50 pieces/carton
AP086	Super YY Air Pump	Double Outlet - 500L/H	5 W	50 pieces/carton

AIR AID

AC/DC Air Pump

15 hours supply of air during power failures! It's the perfect aquarium backup.

- Automatically switches to battery (DC) mode
- Low noise, low vibration.
- AC / DC powered. Functions as a normal air pump but automatically switches to DC mode during a power failure.
- 15 hours of backup aeration.
- Energy saving Pulsing Mode that further increases battery life.
- Low noise, low vibration.
- Increases oxygen levels in your aquarium.



Code No	Description	Max Output (min)/ Outlet	Power Consumption	Pressure	Packing
AP097	Air Aid 120	2L / Minute	2 W	>0.014Mpa	40 pieces/carton
AP098	Air Aid 240	2L / Minute	4 W	>0.014Mpa	40 pieces/carton

RANGER 90000 AQUARIUM AUTO-RECHARGE AIR PUMP

- Durable & Reliable
- Hi & Lo Flow Control
- Essential mechanism are made in Japan
- Powerful & Silent
- Battery will last longer

- Able to operate at an interval of one minute when turn to "Lo" position during prolong power failure up to 15 hours & above.
- Super powerful and silent.
- Adopts ISO 9000 approved device with super quality water-free charging battery. It has designed with preventive overloading and discharging electronic wiring device to prolong the service life of the battery.



Auto recharge H / L Flow Control

Code No	Max. Flow Rate	Power Consumption	Packing
AP073	240 L/H	12 W	6 pieces/carton

ZERO NOISE AIR PUMP

- Super Silent & Stable
- Super Value for Money
- Super Power & Reliable



Code No	Description	Power Consumption	Packing
AP083	Zero Noise Z-1000	Single Outlet-1.8 W	48 pieces/carton
AP084	Zero Noise Z-2000	Double Outlet-2.5 W	36 pieces/carton

SUPER PRECISION XTREME AIR PUMP

- For Depths up to 1.80M!
- Super Silent & Stable
- Super Value for Money
- Super Power & Reliable
- Ideal For Big Aquariums And Marine Skimmers!

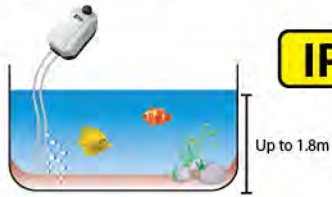

Code No	Specification	Power Consumption	Packing
AP089	Double Outlet-2x360 L/H	10 W	24 pieces/carton

SUPER PRECISION 18000 AIR PUMP

- Complete range of air pumps for aquarium use
- Made with high quality raw materials and in different pumping capabilities like knob control and four outlet fine tuning
- Superb air flow power, reliable, durable safe and silent
- Real value for money



Code No	Specification	Power Consumption	Packing
AP18000	Four Outlet Fine Tuning-720 L/H	7 W	12 pieces/carton

SUPER PRECISION AIR PUMP

- Complete range of air pumps for aquarium use
- Made with high quality raw materials and in different pumping capabilities like Fine Tuning control and Single / Double outlet
- Superb air flow power, reliable, durable safe and silent
- Real value for money



Code No	Description	Specification	Power Consumption	Packing
AP1000	Precision 1000 Air Pump	Single Outlet-80 L/H	2.6 W	60 pieces/carton
AP3000	Precision 3000 Air Pump	Single Outlet Fine Tuning-80 L/H	2.6 W	60 pieces/carton
AP7000	Precision 7000 Air Pump	Double Outlet-200 L/H	3.3 W	36 pieces/carton
AP9000	Precision 9000 Air Pump	Double Outlet Fine Tuning-200 L/H	3.3 W	36 pieces/carton

SUPER PRECISION 1000 AIR PUMP-AIR STONE KIT / BUBBLE HOSE KIT

- Super Silent & Stable
- Super Value for Money
- Super Power & Reliable



Airpump



2m Airline



Air Stone

Code No	Description	Specification	Power Consumption	Packing
AP1000ASK	Precision 1000 Air Stone Kit	Single Outlet-80 L/H	2.6 W	36 pieces/carton

SUPER PRECISION AC / DC 99000 AIR PUMP

The Ultimate Backup Aquarium Air Pump

- Super Silent & Stable
- Super Power & Reliable
- Superior Battery Life
- Airflow Control-Valve

Features :

- Automatically switches from AC to DC (Battery) mode during a power failure
- Airflow Control-valve enables users to choose their preferred airflow
- Battery On / Off Switch prolongs battery-life when device is not in use
- Battery offers up to 10 hours of backup
- ISO 9001 Certified Battery with superior battery features preventive overloading and discharging electronic wiring device to prolong the server life of the battery



Code No	Description	Specification	Power Consumption	Packing
AP090	Super Precision AC / DC 99000 Air Pump	Double Outlet-300 L/H	10 W	8 pieces/carton

SUPER PRECISION DC BATTERY AIR PUMP

- Super Silent & Stable
- Super Power & Reliable
- Air-tube and Air Stone Included
- Ideal for Transporting Livestock
- Battery Operated Portable Air Pump



Code No	Description	Specification	Packing
BP013	Super Precision Dc Battery Air Pump	Battery Operated Portable Air Pump	60 pieces/carton

HI-BLOW

**Applications:**

- Fish breeding equipment (oxygen supply)
- Low frequency therapeutic equipment and other medical & scientific apparatus
- Septic tank (biological contact aeration)
- Bubble bath (air bubble injection)

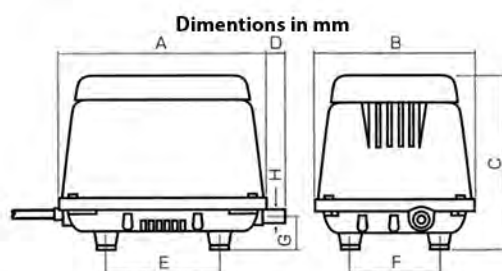
**Specifications:**

TYPE	HP20	HP40	HP60	HP80	HP100	HP120	HP150	HP200
Rated Voltage (V)	AC100 / 120 / 220 - 240							
Power Supply Frequency (Hz)	50 60	50 60	50 60	50 60	50 60	50 60	50 60	50 60
Normal Pressure (kPa)	9.8	12.8	14.7	14.7	17.7	17.7	20	20
Exhaust Volume (1min)	18 20	40	60	80	100	120	150	200
Power Consumption (W)	17	38	51	71	95 100	115 125	125 155	210 250
Noise Level (dBA - 1m)	31	32	35	36	38	40	45 47	46 48
Weight (kg)	3.2	5.7	7.0	7.0	8.5	8.5	9.0	9.0

TYPE	A	B	C	D	E	F	G	H
HP20	182	138	170	21	92	78	37	ø18
HP40	208	171	190	20	120	90	37	ø18
HP60 / HP80	235	180	196	21	130	100	37	ø18
HP100 / HP120	256	200	222	20	140	110	37	ø18
HP150 / HP200	256	200	222	20	140	110	37	ø18

HI-BLOW BABY

HB076 (12 pieces/carton)

Applications:

- Fish breeding equipment (oxygen supply)
- Air mat (continuous air exhaust)
- Air bearing
- Burner (air supply)
- Scientific & chemical instruments (analysis and agitation)



Dimensions in mm

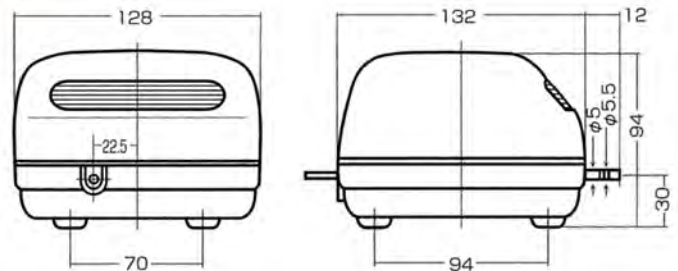

Performance Curves

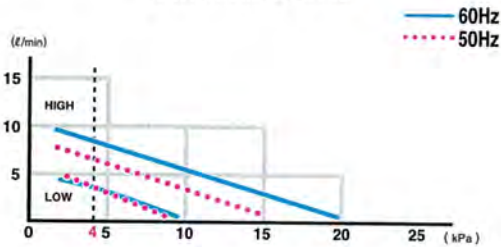

Specifications:

TYPE		C-5F			
		* "HIGH" SW		* "LOW" SW	
Rated Voltage	V	AC100 / 120 / 220~240			
Power Supply Frequency	Hz	50	60	50	60
Normal Pressure	kPa	4.0			
Exhaust Volume	l/min	6.5	8.0	3.5	3.5
Power Consumption	W	8.5		5.5	4.5
Noise Level	dB(A)(1m)	28	30	27	29
Weight	kg	1.0			

FIGHTER 2 PORTABLE BATTERY PUMP

Prevent humidity and water from getting into the pump, especially due to salt water. This special design will very much prolong the life of motor. It can be used under the rain or sunshine. But the pump cannot be used inside the water.

ADVANTAGES:

- More durable
- More reliable
- Battery will last longer
- Essential mechanism are made in Japan
- More powerful
- More silent
- Latest technology & design



Code No
BP009

Description
Fighter 2

Specification
Portable BP

Packing
60 pieces/carton

EVO



FEATURES

- **Intense Vivid Colours**
Brings out your fish's natural colour in greater intensity and vividness.
- **Miracle Spectrum**
Unique technology that instantly enhances your fishes by giving a unique shine and colour depth on the scales instead of a flat dull colour.
- **Sunlit Effect**
Simulates natural sunlight to create graceful surface ripples in your aquarium for a more natural look and feel.
- **Adjustable Brightness**
Electronic controller for selecting 8 brightness levels.
- **Energy Saving**
Low electrical power consumption, greater energy savings!
- **Cool Operation**
Low heat emission from LEDs compared to other light forms.



EXAMPLE



Code No.	Description	Extendable Length / Height	Watt (RGB)	Packing
AL618	Evo Slim Miracle LED 30cm	30 - 35cm / 13cm	22W (18 bulb)	12 pieces/carton
AL619	Evo Slim Miracle LED 45cm	45 - 50cm / 13cm	29W (24 bulb)	12 pieces/carton
AL615	Evo Slim Miracle LED 58cm	58 - 63cm / 13cm	43W (36 bulb)	12 pieces/carton
AL616	Evo Slim Miracle LED 86cm	86 - 91cm / 13cm	58W (48 bulb)	12 pieces/carton
AL617	Evo Slim Miracle LED 116cm	116 - 121cm / 13cm	86W (72 bulb)	12 pieces/carton

EVO



FEATURES

- Aquatic Plant Spectrum**
 Designed with unique wide coverage 10,000K CCT White LEDs, providing the best spectrum and deep penetration to support general aquatic plant growth.
- Adaptive Installation**
 The light set comes with clever clamps and stainless-steel legs to allow the light set to extend horizontally and fit the tank width nicely. It also allows the light set height to be adjusted up to 13cm high to provide flexible light coverage.
- Adjustable Brightness**
 Electronic controller for selecting 8 brightness levels
- Energy Saving**
 Low electrical power consumption, greater energy savings!
- Cool Operation**
 Low heat emission from LEDs compared to other light forms.

EXAMPLE



Include one set of
Lamp Holder,
Power Adapter and
Lamp controller :



10,000K CCT White LEDs :



Code No.	Description	Extendable Length / Height	Watt (10000k)	Packing
AL603	Evo Slim Planted LED 30cm	30 - 35cm / 13cm	22W (63 bulb)	12 pieces/carton
AL604	Evo Slim Planted LED 45cm	45 - 50cm / 13cm	29W (84 bulb)	12 pieces/carton
AL605	Evo Slim Planted LED 60cm	60 - 65cm / 13cm	44W (126 bulb)	12 pieces/carton
AL606	Evo Slim Planted LED 90cm	90 - 95cm / 13cm	66W (189 bulb)	12 pieces/carton
AL607	Evo Slim Planted LED 120cm	120 - 125cm / 13cm	88W (252 bulb)	12 pieces/carton

EVO SLIM LED *Blue + White*

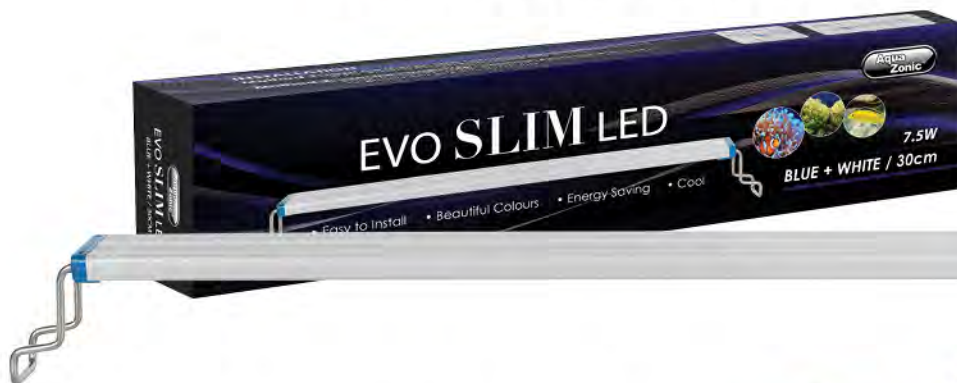

- **Easy to Install.** Extendable Leg and Clamp (included) allow the light to be easily mounted.
- **Beautiful Colours.** Daylight White + Actinic Blue that is close to natural daylight.
- **Energy Saving.** Low electrical consumption, greater energy savings!
- **Cool.** Low heat emission compared to other light forms.



Code No.	Description	Length	Watt (Blue + 14000k)	Packing
AL595	Evo Slim LED Blue + White	30cm	7.5W (0.50 x 8 + 0.50 x 7)	24 pieces/carton
AL596	Evo Slim LED Blue + White	36cm	9W (0.50 x 9 + 0.50 x 9)	24 pieces/carton
AL597	Evo Slim LED Blue + White	45cm	10.5W (0.50 x 11 + 0.50 x 10)	24 pieces/carton
AL598	Evo Slim LED Blue + White	60cm	12W (0.50 x 12 + 0.50 x 12)	24 pieces/carton

EVO SLIM LED *Actinic Blue*



- **Easy to Install.** Extendable Leg and Clamp (included) allow the light to be easily mounted.
- **Beautiful Colours.** Actinic Blue that further enhances blue colours.
- **Energy Saving.** Low electrical consumption, greater energy savings!
- **Cool.** Low heat emission compared to other light forms.

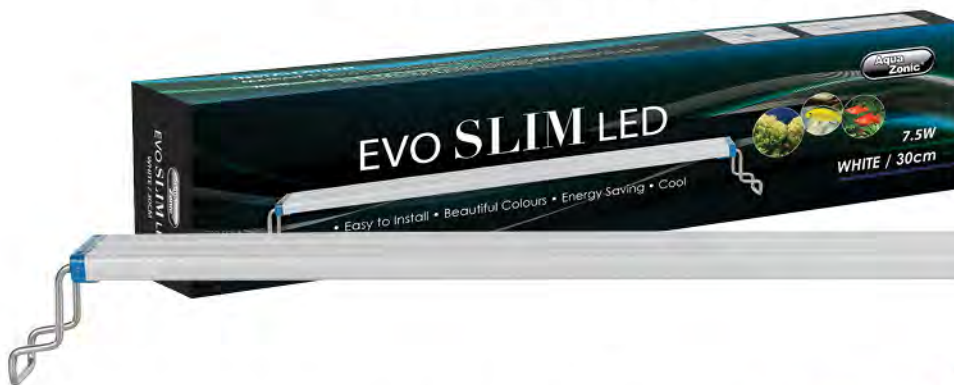

Code No.	Description	Length	Watt (Actinic Blue)	Packing
AL599	Evo Slim LED Actinic Blue	30cm	7.5W (0.50 x 15)	24 pieces/carton
AL601	Evo Slim LED Actinic Blue	45cm	10.5W (0.50 x 21)	24 pieces/carton
AL602	Evo Slim LED Actinic Blue	60cm	12.0W (0.50 x 24)	24 pieces/carton

EVO SLIM LED *White*

- **Easy to Install.** Extendable Leg and Clamp (included) allow the light to be easily mounted.
- **Beautiful Colours.** Daylight White that is close to natural daylight .
- **Energy Saving.** Low electrical consumption, greater energy savings!
- **Cool.** Low heat emission compared to other light forms.

Code No.	Description	Length	Watt (10000k)	Packing
AL536	Evo Slim LED White	30cm	7.5W (0.50 x 15)	24 pieces/carton
AL575	Evo Slim LED White	36cm	9W (0.50 x 18)	24 pieces/carton
AL537	Evo Slim LED White	45cm	10.5W (0.50 x 21)	24 pieces/carton
AL538	Evo Slim LED White	60cm	12W (0.50 x 24)	24 pieces/carton

EVO SLIM LED  *Tropical Red*

- **Easy to Install.** Extendable Leg and Clamp (included) allow the light to be easily mounted.
- **Beautiful Colours.** Tropical Red that further enhances red colours.
- **Energy Saving.** Low electrical consumption, greater energy savings!
- **Cool.** Low heat emission compared to other light forms.

Code No.	Description	Length	Watt (X led + tropical red + 10k + pink)	Packing
AL533	Evo Slim LED RGB	30cm	5.94W (0.24 x 6) + (0.5 x 3) + (0.5 x 3) + (0.5 x 3)	24 pieces/carton
AL576	Evo Slim LED RGB	36cm	6.66W (0.24 x 9) + (0.5 x 3) + (0.5 x 3) + (0.5 x 3)	24 pieces/carton
AL534	Evo Slim LED RGB	45cm	8.16W (0.24 x 9) + (0.5 x 4) + (0.5 x 4) + (0.5 x 4)	24 pieces/carton
AL535	Evo Slim LED RGB	60cm	12.6W (0.24 x 15) + (0.5 x 6) + (0.5 x 6) + (0.5 x 6)	24 pieces/carton

EVO SLIM DOUBLE LED

Double the brightness, double the coverage! *White*



- **Double the brightness , double the coverage!**
- **Easy to Install.** Extendable Leg and Clamp (included) allow the light to be easily mounted.
- **Beautiful Colours.** Daylight White that is close to natural daylight .
- **Energy Saving.** Low electrical consumption, greater energy savings!
- **Cool.** Low heat emission compared to other light forms.

Code No.	Description	Length	Watt (10000k)	Packing
AL544	Evo Slim Double LED White	60cm	24W (0.50 x 48)	12 pieces/carton
AL545	Evo Slim Double LED White	90cm	39W (0.50 x 78)	12 pieces/carton
AL546	Evo Slim Double LED White	120cm	54W (0.50 x 108)	12 pieces/carton
AL547	Evo Slim Double LED White	150cm	63W (0.50 x 126)	12 pieces/carton

EVO SLIM DOUBLE LED

Double the brightness, double the coverage! *Tropical Red*



- **Double the brightness , double the coverage!**
- **Easy to Install.** Extendable Leg and Clamp (included) allow the light to be easily mounted.
- **Beautiful Colours.** Tropical Red that further enhances red colours.
- **Energy Saving.** Low electrical consumption, greater energy savings!
- **Cool.** Low heat emission compared to other light forms.

Code No.	Description	Length	Watt (X led + tropical red + 10k + pink)	Packing
AL548	Evo Slim Double LED RGB	60cm	25.2W (0.24 x 30) + (0.5 x 6) + (0.5 x 12) + (0.5 x 18)	12 pieces/carton
AL549	Evo Slim Double LED RGB	90cm	34.08W (0.24 x 42) + (0.5 x 8) + (0.5 x 16) + (0.5 x 24)	12 pieces/carton
AL550	Evo Slim Double LED RGB	120cm	51.84W (0.24 x 66) + (0.5 x 12) + (0.5 x 24) + (0.5 x 36)	12 pieces/carton
AL551	Evo Slim Double LED RGB	150cm	60.72W (0.24 x 78) + (0.5 x 14) + (0.5 x 28) + (0.5 x 42)	12 pieces/carton

EVO MINI LED



Features

- Easy to Install. Extendable Leg and Clamp (included) allow the LED to be easily mounted
- Beautiful Colours. Featuring OF® 'X' LED and Super Sun LED that display your tank in full color spectrum. Spectra Red LED further enhances red colours.
- Energy Saving. Low electricity consumption, greater energy savings!
- Cool. Low heat emission compared to other light forms.

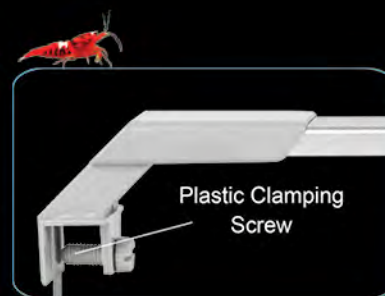

Plastic Clamping
Screw

Code No.

AL591
AL592
AL593
AL594

Description

15cm (15 - 23cm)
25cm (25 - 33cm)
30cm (30 - 38cm)
40cm (40 - 48cm)

Specification (Super Sun) + (X LED)

2.22W - (0.5 x 3) + (0.24 x 3)
4.44W - (0.5 x 6) + (0.24 x 6)
6.66W - (0.5 x 9) + (0.24 x 9)
8.88W - (0.5 x 12) + (0.24 x 12)

Packing

24 pieces/carton
24 pieces/carton
24 pieces/carton
24 pieces/carton

EVO SUPER SUN LED

High Power LED



FEATURES

- **Intense Light Penetration.** Individual powerful 5W LEDs allows the light to penetrate and reach the bottom of your aquarium.
- **Easy to Install.** Extendable Leg and Clamp (included) allow the light to be easily mounted.
- **Energy Saving.** Low electrical consumption, greater energy savings!
- **Cool.** Low heat emission compared to other light forms.



SPECTRUM

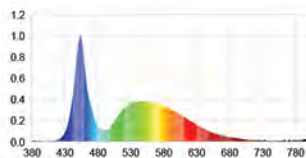

White

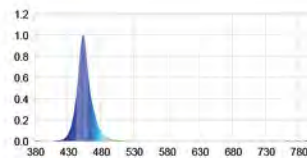

Blue

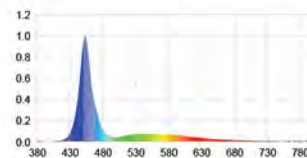

Blue + White

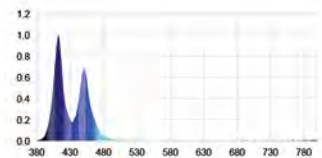

Blue + Indigo

Code No.	Description	Length	Watt	Packing
AL552	Evo Super Sun LED	30cm	15W = 8000K (5W x 3)	12 pieces/carton
AL553	Evo Super Sun LED	45cm	20W = 8000K (5W x 4)	12 pieces/carton
AL554	Evo Super Sun LED	60cm	25W = 8000K (5W x 5)	12 pieces/carton
AL555	Evo Super Sun LED	90cm	40W = 8000K (5W x 8)	12 pieces/carton
AL556	Evo Super Sun LED	120cm	50W = 8000K (5W x 10)	12 pieces/carton
AL557	Evo Super Sun LED	30cm	15W = Blue (5W x 3)	12 pieces/carton
AL558	Evo Super Sun LED	45cm	20W = Blue (5W x 4)	12 pieces/carton
AL559	Evo Super Sun LED	60cm	25W = Blue (5W x 5)	12 pieces/carton
AL560	Evo Super Sun LED	90cm	40W = Blue (5W x 8)	12 pieces/carton
AL561	Evo Super Sun LED	120cm	50W = Blue (5W x 10)	12 pieces/carton
AL562	Evo Super Sun LED	30cm	15W = Blue + 8000K (5W x 2) + (5W x 1)	12 pieces/carton
AL563	Evo Super Sun LED	45cm	20W = Blue + 8000K (5W x 2) + (5W x 2)	12 pieces/carton
AL564	Evo Super Sun LED	60cm	25W = Blue + 8000K (5W x 3) + (5W x 2)	12 pieces/carton
AL565	Evo Super Sun LED	90cm	40W = Blue + 8000K (5W x 4) + (5W x 4)	12 pieces/carton
AL566	Evo Super Sun LED	120cm	50W = Blue + 8000K (5W x 5) + (5W x 5)	12 pieces/carton
AL567	Evo Super Sun LED	30cm	15W = Blue + Indigo (5W x 2) + (5W x 1)	12 pieces/carton
AL568	Evo Super Sun LED	45cm	20W = Blue + Indigo (5W x 2) + (5W x 2)	12 pieces/carton
AL569	Evo Super Sun LED	60cm	25W = Blue + Indigo (5W x 3) + (5W x 2)	12 pieces/carton
AL570	Evo Super Sun LED	90cm	40W = Blue + Indigo (5W x 4) + (5W x 4)	12 pieces/carton
AL571	Evo Super Sun LED	120cm	50W = Blue + Indigo (5W x 5) + (5W x 5)	12 pieces/carton

ECO DOUBLE Submersible LED

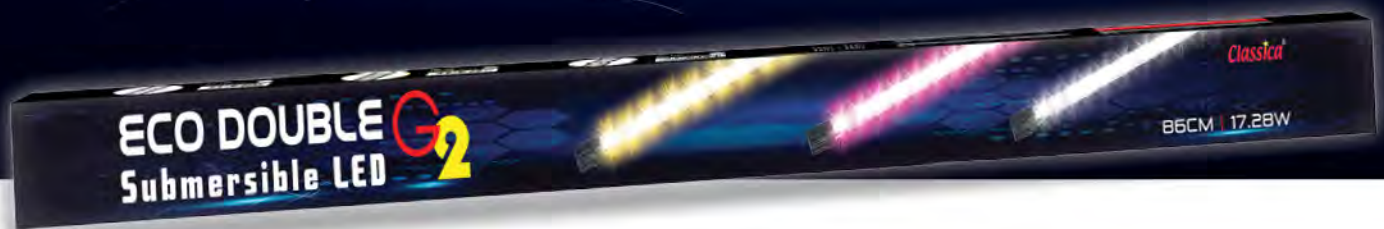
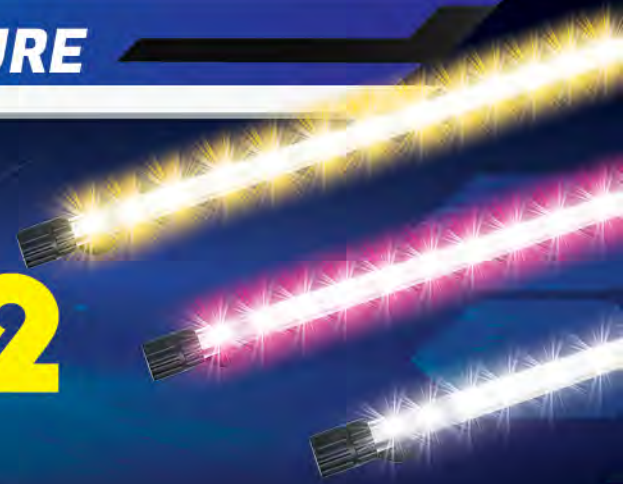

Features

- High Quality sealing for durable and reliable waterproofing.
- Improved extended life span of Light-emitting Diodes (LED).
- Sleek design fits onto any types of aquarium tanks.
- Low heat emission as compared to traditional fluorescent tubes.
- Low energy consumption resulting in greater savings over time
- LEDs being chemical-free and non-toxic making it safe for use and for the environment.



Tropical Pink

Installation Options



Tropical Yellow



Tropical Sun

Code No.	Length	LED	Watt	Power Consumption	Packing
WL141	56cm	Tropical Pink	0.24W x 42	10.08W	12 pieces/carton
WL142	86cm	Tropical Pink	0.24W x 72	17.28W	12 pieces/carton
WL143	115cm	Tropical Pink	0.24W x 96	23.04W	6 pieces/carton
WL144	143cm	Tropical Pink	0.24W x 120	28.80W	6 pieces/carton
WL145	56cm	Tropical Yellow	0.24W x 42	10.08W	12 pieces/carton
WL146	86cm	Tropical Yellow	0.24W x 72	17.28W	12 pieces/carton
WL147	115cm	Tropical Yellow	0.24W x 96	23.04W	6 pieces/carton
WL148	143cm	Tropical Yellow	0.24W x 120	28.80W	6 pieces/carton
WL149	56cm	Tropical Sun	0.24W x 42	10.08W	12 pieces/carton
WL150	86cm	Tropical Sun	0.24W x 72	17.28W	12 pieces/carton
WL151	115cm	Tropical Sun	0.24W x 96	23.04W	6 pieces/carton
WL152	143cm	Tropical Sun	0.24W x 120	28.80W	6 pieces/carton

SPECTRA REEF

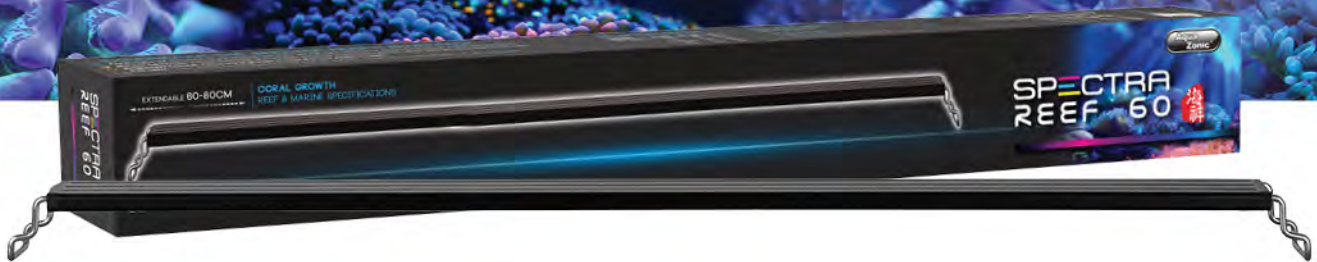

EXPERIENCE THE SPECTRA REEF'S ADVANTAGE

-  **Corals Spec'ed.** Spectra Reef provides the spectrums and PAR value required for optimal corals growth, health and fluorescence.
-  **Miracle Spectrum.** Unique technology that instantly enhances your fishes by giving a unique shine and colour depth on the scales.
-  **Brightness Control.** Adjust the brightness according to your aquarium needs.
-  **Full LEDs.** Lower energy consumption, low heat emission and safer compared to standard fluorescents and metal halides.

LENGTH WITH EXTENDABLE 20CM

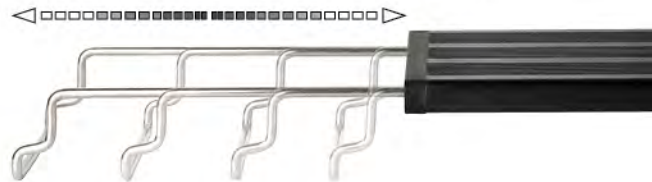

SPECTRUM

Full range of spectrum with the right peaks targeted at Coral growth and fluorescence.

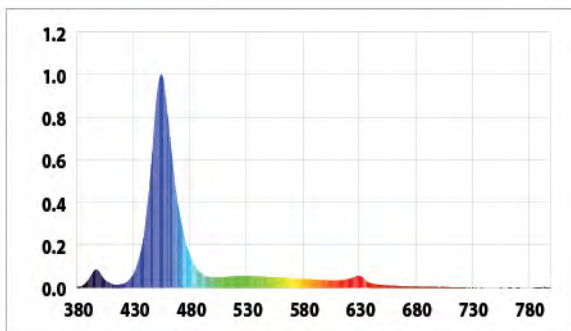

SPECTRA REEF CONTROLLER







Brightness Control

Code No.	Description	Watt (Blue) + (14k) + (RGB) + (MoonlightBlue) + (Blue) + (Indigo)	Packing
AL475	Spectra Reef 60	60cm - 52W (5.0 x 3) + (5.0 x 3) + (1.5 x 2) + (1.5 x 8) + (0.5 x 6) + (0.5 x 8)	6 pieces/carton
AL476	Spectra Reef 90	90cm - 80W (5.0 x 4) + (5.0 x 5) + (1.5 x 4) + (1.5 x 10) + (0.5 x 16) + (0.5 x 12)	6 pieces/carton
AL477	Spectra Reef 120	120cm - 104W (5.0 x 6) + (5.0 x 6) + (1.5 x 4) + (1.5 x 14) + (0.5 x 14) + (0.5 x 16)	6 pieces/carton
AL478	Spectra Reef 150	150cm - 132W (5.0 x 7) + (5.0 x 8) + (1.5 x 6) + (1.5 x 18) + (0.5 x 22) + (0.5 x 20)	6 pieces/carton

SPECTRA PLANTED



EXPERIENCE THE SPECTRA PLANTED'S ADVANTAGE

-  **Hydrophytes Spec'ed.** Spectra Planted provides the spectrums and PAR value required for optimal Aquatic plants (Submerged and Emergent, Green and Red Foliage) growth and health.
-  **Miracle Spectrum.** Unique technology that instantly enhances your fishes by giving a unique shine and colour depth on the scales.
-  **Brightness Control.** Adjust the brightness according to your aquarium needs.
-  **Full LEDs.** Lower energy consumption, low heat emission and safer compared to standard fluorescents and metal halides.

LENGTH WITH EXTENDABLE 20CM

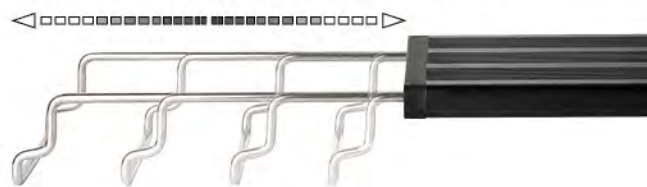

SPECTRUM

Full range of spectrum with the right peaks targeted at Aquatic Plant growth for all submerged and emergent plants with Green or Red foliage.

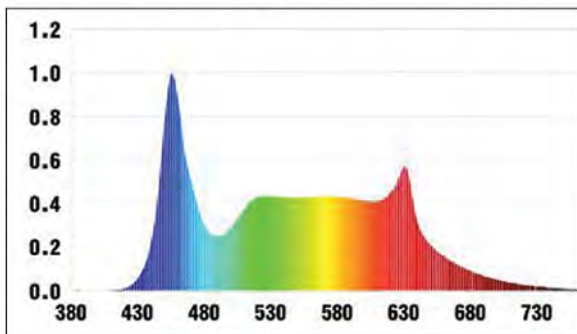

SPECTRA PLANTED CONTROLLER



Brightness Control

Code No.	Description	Watt (5000k) + (RGB) + (4500k)	Packing
AL479	Spectra Planted 60	60cm - 36W (1.5 x 12) + (1.5 x 6) + (1.5 x 6)	6 pieces/carton
AL480	Spectra Planted 90	90cm - 54W (1.5 x 18) + (1.5 x 9) + (1.5 x 9)	6 pieces/carton
AL481	Spectra Planted 120	120cm - 72W (1.5 x 24) + (1.5 x 12) + (1.5 x 12)	6 pieces/carton
AL482	Spectra Planted 150	150cm - 90W (1.5 x 30) + (1.5 x 15) + (1.5 x 15)	6 pieces/carton

SPECTRA KOI

BRING OUT THE COLOR!
FOR ALL TYPES OF NISHIKIGOI (KOI).



EXPERIENCE THE SPECTRA KOI'S ADVANTAGE

- **Tanning Effect.** Helps develop your Koi's Chromatophores (pigment cells)
- **Intense Vivid Colours.** Brings out your Koi's natural color in greater intensity and vividness
- **Miracle Spectrum.** Unique technology that instantly enhances your Koi by giving a unique shine and colour depth on the scales instead of a flat dull colour
- **Energy Efficient Full LEDs.** Lower energy consumption, low heat emission and safer compared to standard fluorescents and metal halides
- **Long Lifespan.** Up to 30,000 hours LED lifespan

REALISTIC AND EXCITING COLOURS NEVER THOUGHT POSSIBLE.

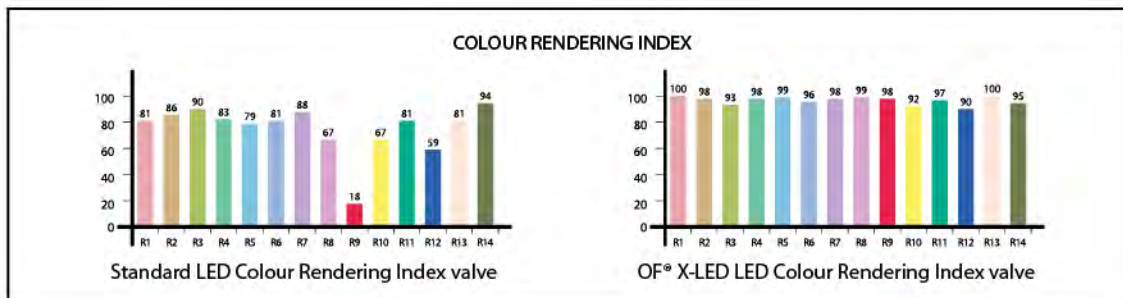

APPLICATIONS

Color Enhancement of all types of Nishikigo varieties, including Kohaku, Sanke, Showa, Tancho, Asagi, etc

INSTALLATION

Hanging Kits that provides numerous installation options

* Use in Dainichi Koi Farm





Code No.	Description	Length	Product Dimension	Power Consumption	Cable Length
AL572	Spectra Koi 90	90cm	900 x 300 x 35mm	159W	5m
AL573	Spectra Koi 120	120cm	1200 x 300 x 35mm	207W	5m

SPECTRA MIRACLE LED



Realistic and exciting colours never thought possible.

Features

- VIVID** Intense Vivid Colours. Brings out your fish's natural colour in greater intensity and vividness
-  **Miracle Spectrum.** Unique technology that instantly enhances your fishes by giving a unique shine and colour depth on the scales instead of a flat dull colour
-  **Sunlit Effect.** Simulates natural sunlight to create graceful surface ripples in your aquarium for a more natural look and feel
-  **Full LEDs.** Lower energy consumption, low heat emission and safer compared to standard fluorescents and metal halides

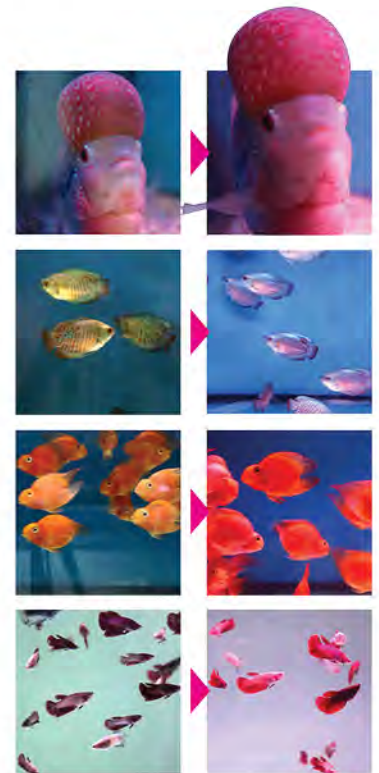

**REALISTIC AND EXCITING COLOURS
NEVER THOUGHT POSSIBLE**

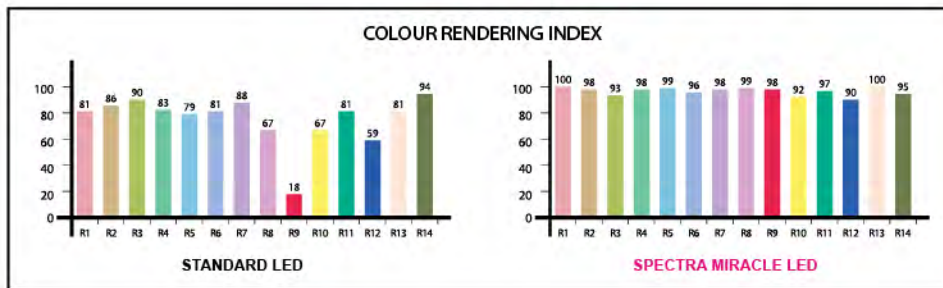

Code No.	Description	Specification Watt (11000k) + RGB + RGB	Packing
AL504	Spectra Miracle 60	60cm - 26.52W (0.50 x 12) + (0.24 x 48) + (1.50 x 6)	6 pieces/carton
AL505	Spectra Miracle 90	90cm - 38.34W (0.50 x 18) + (0.24 x 66) + (1.50 x 9)	6 pieces/carton
AL506	Spectra Miracle 120	120cm - 51.60W (0.50 x 24) + (0.24 x 90) + (1.50 x 12)	6 pieces/carton
AL517	Spectra Miracle 150	150cm - 64.14W (0.50 x 30) + (0.24 x 111) + (1.50 x 15)	4 pieces/carton
AL518	Spectra Miracle 180	180cm - 76.68W (0.50 x 36) + (0.24 x 132) + (1.50 x 18)	4 pieces/carton

SUPREME AROWANA

Colour Enhancement LED • Slim Body

- Replicates natural sunlight to provide perfect rendering of your Arowana's natural colours
- Creates a unique shine and colour depth on Arowana scales instead of a flat red / gold colour
- Helps develop your Arowana's Chromatophores (pigment cells)
- Lower energy consumption, less heat generated and safer compared to T5 / T8 Lights



• PVC casing for safe transportation

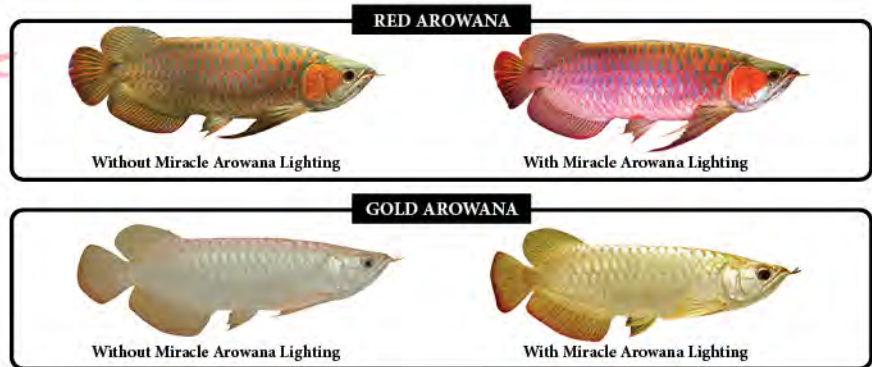

Components



Code No.	Description	Specification	Power	Packing
AL519	Supreme Red Arowana Colour Enhancement LED	88cm	30W	6 pieces/carton
AL520	Supreme Red Arowana Colour Enhancement LED	115cm	36W	6 pieces/carton
AL521	Supreme Red Arowana Colour Enhancement LED	145cm	45W	6 pieces/carton
AL522	Supreme Red Arowana Colour Enhancement LED	175cm	57W	6 pieces/carton
AL523	Supreme Gold Arowana Colour Enhancement LED	88cm	30W	6 pieces/carton
AL524	Supreme Gold Arowana Colour Enhancement LED	115cm	36W	6 pieces/carton
AL525	Supreme Gold Arowana Colour Enhancement LED	145cm	45W	6 pieces/carton
AL526	Supreme Gold Arowana Colour Enhancement LED	175cm	57W	6 pieces/carton

SUBMERSIBLE COLOR-CHANGEABLE LED LIGHTING

Enhance Your Arowana / Fish Natural Beauty

- 6 Interchangeable colors mode
- Water Proofing Design
- High Intensity Output
- Enhance coloration
- Easy Installation

Features

OF® SUBMERSIBLE AROWANA COLOR-CHANGEABLE LED LIGHTING is a special submersible lighting designed for all kinds of ornamental fishes. This lamp has six selectable colours with strong water penetration to create a visual feast for your viewing pleasure!



Components

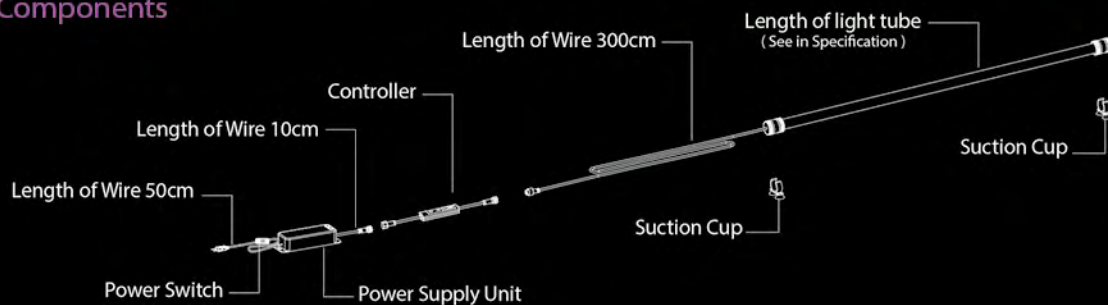

Code No.	Specification	Power Consumption	Packing
WL136	56cm	15W	6 pieces/carton
WL137	86cm	24W	6 pieces/carton
WL138	115cm	33W	6 pieces/carton
WL139	143cm	39W	6 pieces/carton
WL140	173cm	48W	6 pieces/carton

SUBMERSIBLE LED TANNING LIGHTING



RoHS CE

Feature:

- Low energy consumption results in greater savings over time
- Long life span of Light-emitting Diodes (LED)
- Low heat emission compared to standard fluorescents
- Quality sealing for reliable waterproofing
- Slim design fits onto any types of aquarium tanks
- LEDs being chemical-free and non-toxic are safe to use in submerged conditions

Benefit:

- Coloration developed will not fade
- Complements your existing lighting system
- Develops deeper red or richer gold scales in your Arowana within 30 days
- Energy saving, safe and non-toxic
- Tested and proven to improve and intensify fish coloration



* Size Available: 56cm, 86cm, 115cm, 143cm, 173cm

RED AROWANA



Before



Colour Cells In The Scales







After

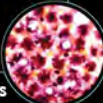

Colour Cells In The Scales



GOLD AROWANA



Before



Colour Cells In The Scales

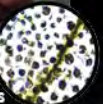



After



Colour Cells In The Scales





Code No	Specification	Packing
WL092	56cm - 13.5 W	12 pieces/carton
WL093	86cm - 22.5 W	6 pieces/carton
WL094	115cm - 31.5 W	6 pieces/carton
WL095	143cm - 39 W	6 pieces/carton
WL096	173cm - 48 W	6 pieces/carton

SUBMERSIBLE LED MIRACLE LIGHTING



RoHS CE

Feature:

- Slim design fits onto any types of aquarium tanks
- Low energy consumption results in greater savings over time
- Low heat emission compared to standard fluorescents and metal halides
- Long life span of Light-emitting Diodes (LED)
- Water-proof design

Benefit:

- Does not encourage green water
- Instant results
- Can be used in conjunction with Arowana tanning lamp for maximum results
- Light spectrum accentuates the contrast of the Arowana's scales to create a 3D effect without whitewashing the fish
- Simulates the radiance of natural sunlight to showcase the Arowana's natural color while highlighting the graceful movements of surface ripples in your aquarium



* Size Available: 56cm, 86cm, 115cm, 143cm, 173cm



ST-Gold Submersible Miracle Arowana Lighting-Silver

Code No	Specification	Packing
WL102	56cm - 13.5 W	12 pieces/carton
WL103	86cm - 22.5 W	6 pieces/carton
WL104	115cm - 31.5 W	6 pieces/carton
WL105	143cm - 39 W	6 pieces/carton
WL106	173cm - 48 W	6 pieces/carton

ST-Red Submersible Miracle Arowana Lighting-Silver

Code No	Specification	Packing
WL107	56cm - 13.5 W	12 pieces/carton
WL108	86cm - 22.5 W	6 pieces/carton
WL109	115cm - 31.5 W	6 pieces/carton
WL110	143cm - 39 W	6 pieces/carton
WL111	173cm - 48 W	6 pieces/carton

SUPER BRIGHT T5 LIGHT SET

- Reflective arc interior to reflect better lighting capabilities back into tank
- Heat-treated aluminium surface to endure aging and corrosion
- Easy access to light tubes to facilitate easy changing
- Suitable for fresh and marine setups
- Slim design to fit any tank types
- Bracket stands provide
- Maintenance free
- Superior design



Code No

AL144
AL146
AL147
AL282
AL148
AL149
AL150
AL151
AL152

Specification

30cm - 2 x 6 W
40cm - 2 x 14 W
45cm - 2 x 16 W
50cm - 2 x 16 W
60cm - 2 x 24 W
90cm - 2 x 39 W
120cm - 2 x 54 W
150cm - 2 x 80 W
180cm - 4 x 39 W

Packing

12 pieces/carton
12 pieces/carton
12 pieces/carton
12 pieces/carton
6 pieces/carton
6 pieces/carton
4 pieces/carton
4 pieces/carton
4 pieces/carton



* Available in Super Sun & Actinic Blue

Code No

AL122
AL122A
AL123
AL124

Specification

60cm - 24 W x 4 (4 x Sun Tube)
60cm - 24 W x 4 (2 x Sun Tube + 2 x Actinic Blue)
90cm - 39 W x 4 (4 x Sun Tube)
120cm - 54 W x 4 (4 x Sun Tube)

Packing

8 pieces/carton
8 pieces/carton
8 pieces/carton
6 pieces/carton

T8 MAX BRIGHT LIGHT SET

- Experience maximum brightness offered by Max-Bright. Compared with conventional light sets of similar casing - length, Max-Bright's specially designed casing allows you to have longer and brighter light tubes
- Heat-treated aluminium surface to endure aging and corrosion
- Maintenance free
- Reflective arc interior to reflect better lighting capabilities back into tank
- Bracket stands provided
- Easy access to light tubes to facilitate easy changing
- Suitable for fresh and marine setups



T8 Max Bright-Single

Code No	Specification
AL154	60cm - 1 x 18 W
AL156	90cm - 1 x 30 W
AL158	150cm - 1 x 58 W

Packing
6 pieces/carton
6 pieces/carton
6 pieces/carton

T8 Max Bright-Double

Code No	Specification
AL159	45cm - 2 x 15 W
AL160	60cm - 2 x 18 W
AL162	90cm - 2 x 30 W
AL163	120cm - 2 x 36 W
AL164	150cm - 2 x 58 W

Packing
12 pieces/carton
6 pieces/carton
6 pieces/carton
6 pieces/carton
6 pieces/carton



SUPER PL-COMPACT AQUARIUM LAMP

- Reflected arc interior to reflect better lighting capabilities back into tank
- Heat-treated aluminium surface to endure aging and corrosion
- Easy access to light tubes to facilitate easy changing
- Suitable for fresh and marine setups
- Slim design to fit any tank types
- Bracket stands provided
- Maintenance free
- Superior design



Code No	Specification
AL113	90cm - 2 x 36 W
AL114	120cm - 2 x 55 W

Packing
12 pieces/carton
12 pieces/carton

T5 SPEC MAX

- Pendant / hanging-ready (Compatible with most third party fitting; Fittings not included)
- Heat-treated aluminium surface to endure aging and corrosion
- Reflective arc interior to maximise lighting efficiency
- Superior design
- Easy access to light tubes to facilitate easy changing
- Bracket stands provided
- Compact design to fit any tank types
- Suitable for fresh and marine setups



Code No

Specification

Packing

AL418	Double - 28cm-6 W x 2	6 pieces/carton
AL419	Double - 43cm-16 W x 2	6 pieces/carton
AL420	Double - 58cm-24 W x 2	6 pieces/carton
AL421	Double - 88cm-39 W x 2	6 pieces/carton
AL422	Double - 118cm-54 W x 2	6 pieces/carton
AL423	Double - 148cm-80 W x 2	6 pieces/carton
AL445	Single - 28cm-6 W x 1	6 pieces/carton
AL446	Single - 43cm-16 W x 1	6 pieces/carton
AL447	Single - 58cm-24 W x 1	6 pieces/carton
AL448	Single - 88cm-39 W x 1	6 pieces/carton
AL449	Single - 118cm-54 W x 1	6 pieces/carton



T8 SPEC MAX

- Pendant / hanging-ready (Compatible with most third party fitting; Fittings not included)
- Heat-treated aluminium surface to endure aging and corrosion
- Reflective arc interior to maximise lighting efficiency
- Superior design
- Easy access to light tubes to facilitate easy changing
- Bracket stands provided
- Compact design to fit any tank types
- Suitable for fresh and marine setups



Code No	Specification	Packing
AL413	Double - 60cm-18 W x 2	6 pieces/carton
AL416	Double - 120cm-36 W x 2	6 pieces/carton
AL440	Single - 45cm-15 W x 1	6 pieces/carton
AL441	Single - 60cm-18 W x 1	6 pieces/carton
AL442	Single - 75cm-25 W x 1	6 pieces/carton
AL443	Single - 90cm-30 W x 1	6 pieces/carton
AL444	Single - 120cm-36 W x 1	6 pieces/carton

SUPER BRIGHT EXTENDABLE SLIM LED LIGHTING - MARINE

- Slim
- Eco Friendly
- Ripple Effect
- Energy Saving

The Extendable Super Bright LED lamp meshes innovation with a functional design. The extendable arm allows the lamp to be mounted on a wide range of aquarium tanks. It utilizes the new OF 'X' LED, which when combined with 12K & Actinic Blue bulbs provides superior full colour spectrum rendering of marine livestock. Meanwhile, the dual light mood recreates daylight and moonlight conditions for a more natural day cycle. Extendable Super Bright LED, the next generation of compact aquarium lighting.



Code No

Specification

Watt (12000k + X LED) + (Actinic Blue)

AL345	18cm - 7.44 W (1.5 W x 3 + 1.5 W x 1) + (0.24 W x 6)
AL346	30cm - 13.38 W (1.5 W x 5 + 1.5 W x 2) + (0.24 W x 12)
AL347	40cm - 18.60 W (1.5 W x 7 + 1.5 W x 3) + (0.24 W x 15)
AL348	50cm - 21.60 W (1.5 W x 8 + 1.5 W x 4) + (0.24 W x 15)
AL349	60cm - 26.82 W (1.5 W x 11 + 1.5 W x 4) + (0.24 W x 18)
AL350	90cm - 38.76 W (1.5 W x 16 + 1.5 W x 6) + (0.24 W x 24)
AL351	120cm - 52.20 W (1.5 W x 22 + 1.5 W x 8) + (0.24 W x 30)

Packing

12 pieces/carton
12 pieces/carton
12 pieces/carton
12 pieces/carton
12 pieces/carton
6 pieces/carton
6 pieces/carton

SUPER BRIGHT EXTENDABLE SLIM LED LIGHTING - FRESHWATER & PLANTED TANK

- Slim
- Eco Friendly
- Ripple Effect
- Energy Saving

The Extendable Super Bright LED lamp meshes innovation with a functional design. The extendable arm allows the lamp to be mounted on a wide range of aquarium tanks. It utilizes the new OF 'X' LED, which when combined with 8K & 10K bulbs provides a superior full colour spectrum rendering of livestock. Meanwhile, the dual light mood recreates daylight and moonlight conditions for a more natural day cycle. Extendable Super Bright LED, the next generation of compact aquarium lighting.



Code No	Specification	Packing
	Watt (10000k + 8000k + X LED) + (X LED)	
AL352	18cm - 6.72 W (1.5 W x 1 + 1.5 W x 1 + 1.5 W x 2) + (0.24 W x 3)	12 pieces/carton
AL353	30cm - 11.22 W (1.5 W x 2 + 1.5 W x 2 + 1.5 W x 3) + (0.24 W x 3)	12 pieces/carton
AL354	40cm - 15.72 W (1.5 W x 3 + 1.5 W x 3 + 1.5 W x 4) + (0.24 W x 3)	12 pieces/carton
AL355	50cm - 18.72 W (1.5 W x 3 + 1.5 W x 4 + 1.5 W x 5) + (0.24 W x 3)	12 pieces/carton
AL356	60cm - 23.94 W (1.5 W x 4 + 1.5 W x 5 + 1.5 W x 6) + (0.24 W x 6)	12 pieces/carton
AL357	90cm - 35.16 W (1.5 W x 6 + 1.5 W x 8 + 1.5 W x 8) + (0.24 W x 9)	6 pieces/carton
AL358	120cm - 47.88 W (1.5 W x 9 + 1.5 W x 11 + 1.5 W x 10) + (0.24 W x 12)	6 pieces/carton

SUPER BRIGHT LED COMPACT LAMP - MARINE

- Superior CRI** : Featuring OF 'X' LED that displays your tank in full color spectrum.
- Energy Saving** : Low electrical consumption, greater energy savings!
- Cool Light** : Low heat emission compared to other light forms.
- Dual Light-mode** : Recreates the daytime and moonlight conditions of nature.
- Double the Brightness** : Extra bright 1.5W LED bulbs for better illumination.

A slim iconic compact LED lamp. Featuring new OF 'X' LED when combined with 12K & Actinic Blue bulbs provides superior full colour spectrum rendering of livestock, the dual light mood recreates daylight and moonlight conditions for a more natural day cycle. The LED's low heat emission permits minimal changes in the ambient temperature while the focused lighting results in stunning accentuation of your aquarium's interior. The low energy consumption results in greater savings over time. Super Bright LED, the next generation of compact aquarium lighting.



Code No	Specification Watt (12000k + X LED) + (Actinic Blue)	Packing
AL327	20cm - 9.72 W (1.5 W x 5 + 1.5 W x 1) + (0.24 W x 3)	12 pieces/carton
AL328	23cm - 13.44 W (1.5 W x 6 + 1.5 W x 2) + (0.24 W x 6)	12 pieces/carton
AL329	27cm - 16.44 W (1.5 W x 8 + 1.5 W x 2) + (0.24 W x 6)	12 pieces/carton

SUPER BRIGHT LED COMPACT LAMP - FRESH WATER

- Superior CRI** : Featuring OF 'X' LED that displays your tank in full color spectrum
- Energy Saving** : Low electrical consumption, greater energy savings
- Cool Light** : Low heat emission compared to other light forms
- Dual Light-mode** : Recreates the daytime and moonlight conditions of nature
- Double the Brightness** : Extra bright 1.5W LED bulbs for better illumination

A slim iconic compact LED lamp. Featuring new OF 'X' LED when combined with 8K & 10K bulbs provides superior full colour spectrum rendering of livestock, the dual light mood recreates daylight and moonlight conditions for a more natural day cycle. The LED's low heat emission permits minimal changes in the ambient temperature while the focused lighting results in stunning accentuation of your aquarium's interior. The low energy consumption results in greater savings over time. Super Bright LED, the next generation of compact aquarium lighting.



Code No

Specification

Watt (10000k + 8000k + X LED) + (X LED)

Packing

AL330

20cm - 9.48 W (1.5 W x 2 + 1.5 W x 2 + 1.5 W x 2) + (0.24 W x 2)

12 pieces/carton

AL331

23cm - 12.48 W (1.5 W x 2 + 1.5 W x 3 + 1.5 W x 3) + (0.24 W x 2)

12 pieces/carton

AL332

27cm - 15.72 W (1.5 W x 3 + 1.5 W x 4 + 1.5 W x 3) + (0.24 W x 3)

12 pieces/carton

SUPER SLIM DOUBLE BRIGHT G2 LED CLAMPING LAMP

- Slim
- Cool Light
- Energy Saving
- Dual Light-mode
- Non-Toxic
- Ripple Effect

SLIM - The small sized Light-emitting Diode (LED) allows for sleeker, slimmer casing design. Ideal for use with Nano tanks

COOL LIGHT - Low heat emission compared to other light forms

ENERGY SAVING - Low electrical consumption, greater energy savings

DUAL LIGHT-MODE - Recreates the daytime and moonlight conditions of nature

NON-TOXIC - Do not contain harmful chemicals unlike conventional lighting

RIPPLE EFFECT - Shimmering ripple effect resembling natural sunlight



AL308
AL308A



AL309
AL309A

Code No	Specification	Packing
AL308	Silver - 4.32 W (10K x 15) + (Actinic Blue x 3)	12 pieces/carton
AL308A	Black - 4.32 W (10K x 15) + (Actinic Blue x 3)	12 pieces/carton
AL309	Silver - 6.72 W (10K x 24) + (Actinic Blue x 4)	12 pieces/carton
AL309A	Black - 6.72 W (10K x 24) + (Actinic Blue x 4)	12 pieces/carton

SUPER SLIM LED CLAMPING LAMP

- Slim
- Non-Toxic
- Cool Light
- Energy Saving
- Dual Light-Mode

A slim iconic compact LED lamp. Features dual light-mode for aquarist to replicate daylight and moonlight conditions. The LED's low heat emission permits minimal changes in the ambient temperature while the focused lighting result in stunning accentuation of your aquarium's interior. The low energy consumption results in greater savings over time. Super Slim LED, the next generation of compact aquarium lighting.



AL165 & AL167



AL166 & AL168

Code No	Specification	Packing
AL165	Silver - 2 W (20 + 4 Bulb)	12 pieces/carton
AL166	Silver - 3.2 W (32 + 8 Bulb)	12 pieces/carton
AL167	Black - 2 W (20 + 4 Bulb)	12 pieces/carton
AL168	Black - 3.2 W (32 + 8 Bulb)	12 pieces/carton

SUPER MINI LED CLAMPING LAMP

- SLIM
- RIPPLE EFFECT
- ECO FRIENDLY
- ENERGY SAVING

The Super Mini LED's small and slim design makes it suitable for small tanks. It features dual light-mode for aquarist to replicate day or moon-lit conditions. The LED's low heat emission permits minimal changes in the ambient temperature while the low energy consumption means greater energy saving for you. The result is an economical lamp that provides stunning accentuation of your aquarium's interior.



Code No	Specification	Packing
AL383	0.96 W (10K x 8 + Actinic Blue x 4)	24 pieces/carton

SUPER LED CLAMPING LAMP

- Ideal for small sized tank (Below 35cm)
- Fashionable, compact and easy to install it to the aquarium
- Provide the optimum lighting for aquatic need
- Super energy saving (0.6w)
- Economical



Code No	Specification	Packing
AL120	Black - 0.6 W only	40 pieces/carton
AL121	Silver - 0.6 W only	40 pieces/carton

UNIVERSAL CLAMPING LAMP

- 6700K full spectrum illuminations, ideal for aquatic plants and marine reef growth.
- Enhance the red colour of ornamental fish.
- Fashionable, compact and easy to install it to the aquarium.
- Provides the optimum lighting for plants 8-10 hours per day.
- Special electronic ballast (low heat).



AL105 & AL106

AL107 & AL108

Code No	Specification	Packing
AL105	Black-7 W	20 pieces/carton
AL107	Black-11 W	20 pieces/carton
AL106	Silver-7 W	20 pieces/carton
AL108	Silver-11 W	20 pieces/carton



Sunrise Effect



Sunrise Effect



Sunset Effect



Moonlight Effect

MONSTER PENDENT - DEEP BLUE



High Intensity LED Lighting for Marine Aquariums

- Full LED: Energy efficient and eco-friendly
- Smart Timer with Time-Transition-Lighting Technology that progressively brightens or dims LEDs to replicate night-day-night transition
- Light penetration creates natural wave / ripple-like effect
- 30W / 60W LED (14000K): Provides moonlit lighting effect, accentuate florescence of corals & invertebrates and promote coral growth
- 1.5W LED (OF 'S' LED Technology): Provides superior full colour spectrum rendering of fishes, corals and invertebrates amplifying colour contrast for extreme visual delight
- Low heat emission in comparison to HQI lighting
- Non-toxic and does not contain harmful chemicals
- Pendant / hanging-ready (Fittings sold seperately)
- Detachable transformer
- Suitable for tank depth up to 1.5m / up to 2.0m

Code No	Specification	Packing
AL387	Watt (14000k) + (Actinic Blue) + (S LED)	4 pieces/carton
AL388	48 W (30 W x 1) + (1.5 W x 6) + (1.5 W x 6)	4 pieces/carton
	78 W (60 W x 1) + (1.5 W x 6) + (1.5 W x 6)	

MONSTER PENDENT - VIVID DAY



High Intensity LED Lighting for Freshwater Aquariums

- Full LED: Energy efficient and eco-friendly
- Smart Timer with Time-Transition-Lighting Technology that progressively brightens or dims LEDs to replicate night-day-night transition
- Light penetration creates natural wave / ripple-like effect
- 30W / 60W LED (8000K): Provides optimal lighting for plant growth while showcasing your plants in their true 'natural' colours
- 1.5W LED (OF 'S' LED Technology): Provides superior full colour spectrum rendering of fishes and plants, amplifying colour contrast for extreme visual delight
- Low heat emission in comparison to HQI lighting
- Non-toxic and does not contain harmful chemicals
- Pendant / hanging-ready (Fittings sold seperately)
- Detachable transformer
- Suitable for tank depth up to 1.5m / up to 2.0m

Code No	Specification	Packing
AL389	Watt (8000k) + (S LED)	4 pieces/carton
AL390	48 W (30 W x 1) + (1.5 W x 12)	4 pieces/carton
	78 W (60 W x 1) + (1.5 W x 12)	

LED SPOT LIGHT - FOR AQUARIUM, TERRARIUM, POND & GARDEN

- Low Energy Consumption
- Changeable Illumination Modes
- Remote Controlled (GPS system - 25-30m effective radius)
- Stainless Steel Casing
- Adjustable Brightness
- Low Voltage (12V)
- Waterproof



AQUA ZONIC LED SPOT LIGHT is designed for the discerning homeowner with keen eye for design and function. The solid stainless steel casing coupled with rubber sealing detail ensures a construction built to last in outdoor & underwater conditions. In addition, the energy saving LED bulbs enables users to keep their gardens and ponds illuminated through the night whilst using less electricity.

* What's more, AZ LED Spot Light possesses remote control functionality which allows users to control brightness, illumination modes and on/off from the comforts of their home. Now you can be rewarded with a truly stunning night time illumination display in your garden.



Code No	Specification	Packing
WL087	3 W	36 pieces/carton
WL088	9 W	24 pieces/carton
WL089	18 W	12 pieces/carton
WL090	27 W	6 pieces/carton
WL091	36 W	6 pieces/carton



Changeable Color Focus Light



Create Movement & Dramatic to the Aquarium

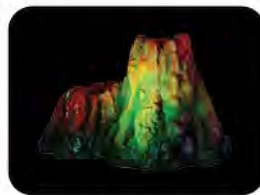

Bring out Specific Detail or Colors Life Stocks



Excellent Accent Illumination for Ornaments



Pond Lighting

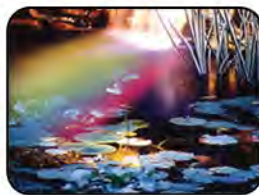

Garden Illumination



Path Lights



Changeable Color Focus Light



WL087 (3W)



WL088 (9W)



WL089 (18W)



WL090 (27W)



WL091 (36W)

T5 LED Tropical



The **T5 LED Tropical** brings out the different natural colours of aquarium fishes, as it is designed to replicate the natural daylight. LED technology reduces energy consumption and prolongs the lifespan of the light.

Features

- Ideal for freshwater aquariums
- Brings out the natural colours of aquarium fishes
- Replicates natural daylight
- Easy replacement for T5 fluorescent tubes
- Replicates ripple effect
- Energy saving compared to traditional T5 fluorescent tubes
- Enhance the colours of the fishes by at least 30%

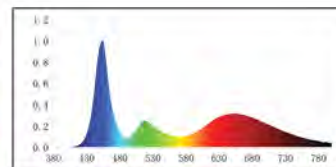

Code No.	Description	Specification	Watt (Pink) + (White 6500k) + (Green) + (Blue)	Packing
LT308	T5 LED Tropical 60	60cm (564mm)	24W (0.2 x 80) + (0.2 x 14) + (0.2 x 13) + (0.2 x 13)	12 pieces/carton
LT309	T5 LED Tropical 90	90cm (864mm)	36W (0.2 x 120) + (0.2 x 20) + (0.2 x 20) + (0.2 x 20)	12 pieces/carton
LT310	T5 LED Tropical 120	120cm (1164mm)	48W (0.2 x 160) + (0.2 x 27) + (0.2 x 27) + (0.2 x 26)	12 pieces/carton

T5 LED Planted



Designed for planted tanks to help stimulate photosynthesis, **T5 LED Planted** brings out the natural colours of aquarium plants, especially green & red. LED technology reduces energy consumption and prolongs the lifespan of the light.

Features

- Ideal for freshwater planted tanks
- Brings out the natural colours of aquarium plants, especially green & red
- Easy replacement for T5 fluorescent tubes
- Energy saving compared to traditional T5 fluorescent tubes
- Replicates ripple effect
- Longer lifespan as compared to traditional T5 fluorescent tubes
- Encourages photosynthesis which induces plant growth

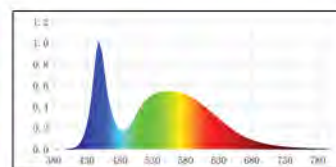

Code No.	Description	Specification	Watt (8000k) + (6400k) + (5400k)	Packing
LT314	T5 LED Planted 60	60cm (564mm)	24W (0.2 x 40) + (0.2 x 40) + (0.2 x 40)	12 pieces/carton
LT315	T5 LED Planted 90	90cm (864mm)	36W (0.2 x 60) + (0.2 x 60) + (0.2 x 60)	12 pieces/carton
LT316	T5 LED Planted 120	120cm (1164mm)	48W (0.2 x 80) + (0.2 x 80) + (0.2 x 80)	12 pieces/carton

T5 LED Marine Blue

Enhance
Deep Sea Feel

Natural Colour



Energy Saving



Ripple Effect

The lighting produced by **T5 LED Marine Blue** replicates the deep sea feel in your aquarium and feature spectrums that are beneficial for corals and other invertebrates to thrive. Through the use of LED technology, it reduces energy consumption and prolongs the light's lifespan.

Features

- Enhances "Deep Sea Feel" for the tank
- Energy saving compared to traditional T5 fluorescent tubes
- Special spectrums ideal for coral growth
- Longer lifespan as compared to traditional T5 fluorescent tubes
- Replicates ripple effect
- Easy replacement for T5 fluorescent tubes

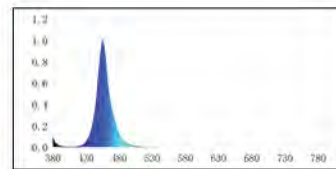
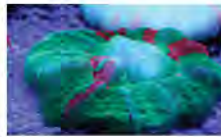

Code No.

LT311
LT312
LT313

Description

T5 LED Marine Blue 60
T5 LED Marine Blue 90
T5 LED Marine Blue 120

Specification

60cm (564mm)
90cm (864mm)
120cm (1164mm)

Watt (Blue) + (Violet)

24W (0.2 x 80) + (0.2 x 40)
36W (0.2 x 120) + (0.2 x 60)
48W (0.2 x 160) + (0.2 x 80)

Packing

12 pieces/carton
12 pieces/carton
12 pieces/carton

T5

LED

Marine White



Natural Sunlight



Natural Colour



Energy Saving



Ripple Effect

The **T5 LED Marine White** was created to help enhance the coloration of your marine fishes by simulating the natural sunlight. Through the use of LED technology, it reduces energy consumption and prolongs the light's lifespan.

Features

- Simulates natural sunlight
- Energy saving compared to traditional T5 fluorescent tubes
- Enhances coloration of marine fishes
- Longer lifespan as compared to traditional T5 fluorescent tubes
- Replicates ripple effect
- Easy replacement for T5 fluorescent tubes

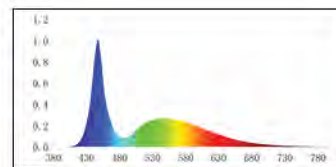
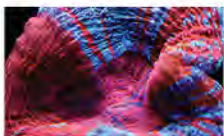

Code No.

LT317
LT318
LT319

Description

T5 LED Marine White 60
T5 LED Marine White 90
T5 LED Marine White 120

Specification

60cm (564mm)
90cm (864mm)
120cm (1164mm)

Watt (13000k)

24W (0.2 x 120)
36W (0.2 x 180)
48W (0.2 x 240)

Packing

12 pieces/carton
12 pieces/carton
12 pieces/carton

T8

LED

Tropical



Ideal for Freshwater Aquariums



Natural Colour



Energy Saving



Ripple Effect

The **T8 LED Tropical** brings out the different natural colours of aquarium fishes, as it is designed to replicate the natural daylight. LED technology reduces energy consumption and prolongs the lifespan of the light.

Features

- Ideal for freshwater aquariums
- Brings out the natural colours of aquarium fishes
- Replicates natural daylight
- Easy replacement for T8 fluorescent tubes
- Replicates ripple effect
- Energy saving compared to traditional T8 fluorescent tubes
- Enhance the colours of the fishes by at least 30%

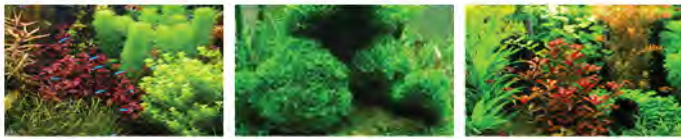

CE

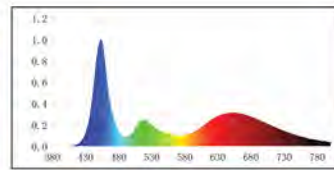

Code No.	Description	Specification	Watt (Pink) + (White 6500k) + (Green) + (Blue)	Packing
LT320	T8 LED Tropical 60	60cm (604mm)	18W (0.2 x 60) + (0.2 x 10) + (0.2 x 10) + (0.2 x 10)	12 pieces/carton
LT321	T8 LED Tropical 75	75cm (754mm)	24W (0.2 x 80) + (0.2 x 14) + (0.2 x 13) + (0.2 x 13)	12 pieces/carton
LT322	T8 LED Tropical 90	90cm (904mm)	30W (0.2 x 100) + (0.2 x 17) + (0.2 x 17) + (0.2 x 16)	12 pieces/carton
LT323	T8 LED Tropical 105	105cm (1054mm)	36W (0.2 x 120) + (0.2 x 20) + (0.2 x 20) + (0.2 x 20)	12 pieces/carton
LT324	T8 LED Tropical 120	120cm (1209mm)	42W (0.2 x 140) + (0.2 x 24) + (0.2 x 23) + (0.2 x 23)	12 pieces/carton

T8

LED

Planted



Encourages Photosynthesis



Natural Colour



Energy Saving



Ripple Effect

Designed for planted tanks to help stimulate photosynthesis, **T8 LED Planted** brings out the natural colours of aquarium plants, especially green & red. LED technology reduces energy consumption and prolongs the lifespan of the light.

Features

- Ideal for freshwater planted tanks
- Brings out the natural colours of aquarium plants, especially green & red
- Easy replacement for T8 fluorescent tubes
- Energy saving compared to traditional T8 fluorescent tubes
- Replicates ripple effect
- Longer lifespan as compared to traditional T8 fluorescent tubes
- Encourages photosynthesis which induces plant growth



CE

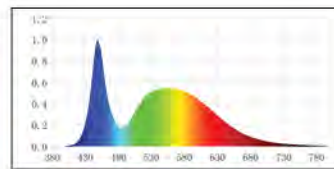

Code No.	Description	Specification	Watt (8000k) + (6400k) + (5400k)	Packing
LT330	T8 LED Planted 60	60cm (604mm)	18W (0.2 x 30) + (0.2 x 30) + (0.2 x 30)	12 pieces/carton
LT331	T8 LED Planted 75	75cm (754mm)	24W (0.2 x 40) + (0.2 x 40) + (0.2 x 40)	12 pieces/carton
LT332	T8 LED Planted 90	90cm (904mm)	30W (0.2 x 50) + (0.2 x 50) + (0.2 x 50)	12 pieces/carton
LT333	T8 LED Planted 105	105cm (1054mm)	36W (0.2 x 60) + (0.2 x 60) + (0.2 x 60)	12 pieces/carton
LT334	T8 LED Planted 120	120cm (1209mm)	42W (0.2 x 70) + (0.2 x 70) + (0.2 x 70)	12 pieces/carton

T8 LED Marine Blue



The lighting produced by T8 LED Marine Blue replicates the deep sea feel in your aquarium and feature spectrums that are beneficial for corals and other invertebrates to thrive. Through the use of LED technology, it reduces energy consumption and prolongs the light's lifespan.

Features

- Enhances "Deep Sea Feel" for the tank
- Energy saving compared to traditional T8 fluorescent tubes
- Special spectrums ideal for coral growth
- Longer lifespan as compared to traditional T8 fluorescent tubes
- Replicates ripple effect
- Easy replacement for T8 fluorescent tubes

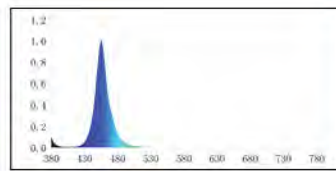

Code No.	Description	Specification	Watt (Blue) + (Violet)	Packing
LT325	T8 LED Marine Blue 60	60cm (604mm)	18W (0.2 x 60) + (0.2 x 30)	12 pieces/carton
LT326	T8 LED Marine Blue 75	75cm (754mm)	24W (0.2 x 80) + (0.2 x 40)	12 pieces/carton
LT327	T8 LED Marine Blue 90	90cm (904mm)	30W (0.2 x 100) + (0.2 x 50)	12 pieces/carton
LT328	T8 LED Marine Blue 105	105cm (1054mm)	36W (0.2 x 120) + (0.2 x 60)	12 pieces/carton
LT329	T8 LED Marine Blue 120	120cm (1209mm)	42W (0.2 x 140) + (0.2 x 70)	12 pieces/carton

T8 LED Marine White



The T8 LED Marine White was created to help enhance the coloration of your marine fishes by simulating the natural sunlight. Through the use of LED technology, it reduces energy consumption and prolongs the light's lifespan.

Features

- Simulates natural sunlight
- Energy saving compared to traditional T8 fluorescent tubes
- Enhances coloration of marine fishes
- Longer lifespan as compared to traditional T8 fluorescent tubes
- Replicates ripple effect
- Easy replacement for T8 fluorescent tubes

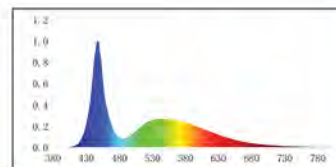
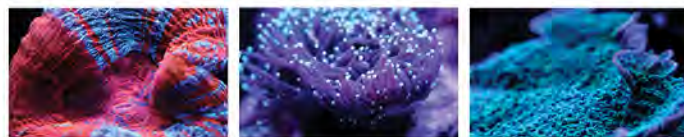

Code No.	Description	Specification	Watt (13000k)	Packing
LT335	T8 LED Marine White 60	60cm (604mm)	18W (0.2 x 90)	12 pieces/carton
LT336	T8 LED Marine White 75	75cm (754mm)	24W (0.2 x 120)	12 pieces/carton
LT337	T8 LED Marine White 90	90cm (904mm)	30W (0.2 x 150)	12 pieces/carton
LT338	T8 LED Marine White 105	105cm (1054mm)	36W (0.2 x 180)	12 pieces/carton
LT339	T8 LED Marine White 120	120cm (1209mm)	42W (0.2 x 210)	12 pieces/carton

SUPER TROPICAL PINK T5 AQUARIUM LAMP

- Superior Light For Fresh Water Planted Aquarium, Tropical and Marine Aquarium
- Accelerate Plant Growth
- Brings Out The Natural Colour of Aquaria Plants, especially Red and Green
- Stimulate Photosynthesis
- Intensify the colour of fishes, especially red



Code No	Specification	Packing
LT0402	24 W - 22" / 55cm	25 pieces/carton
LT0407	39 W - 34" / 85cm	25 pieces/carton
LT0411	54 W - 46" / 115cm	25 pieces/carton
LT0416	80 W - 58" / 145cm	25 pieces/carton

SUPER SUN T5 AQUARIUM LAMP - 12000K

- Bring out the natural colour of aquarium plants, especially green & red
- >80% increase in power & brightness
- Induce plant growth
- Enhance photosynthesis
- Superb lighting for marine Aquarium
- Superior light for fresh water planted aquarium



Code No	Specification	Packing
LT0398	8 W - 11.5" / 288mm	25 pieces/carton
LT0399	16 W - 15.9" / 397mm	25 pieces/carton
LT0401	24 W - 22" / 55cm	25 pieces/carton
LT0406	39 W - 34" / 85cm	25 pieces/carton
LT0410	54 W - 46" / 115cm	25 pieces/carton
LT0415	80 W - 58" / 145cm	25 pieces/carton

SUPER ACTINIC BLUE T5 AQUARIUM LAMP

- Create a Conducive Environment For Invertebrates, Corals and Fishes
- Enhance Deep Sea Feel For The Tank
- Special Light For Marine Aquarium
- Special Moonlight Effect
- Special Blue Actinic Blue



Code No	Specification	Packing
LT0403	24 W - 22" / 55cm	25 pieces/carton
LT0408	39 W - 34" / 85cm	25 pieces/carton
LT0412	54 W - 46" / 115cm	25 pieces/carton
LT0417	80 W - 58" / 145cm	25 pieces/carton

SUPER PLANT T5 AQUARIUM LAMP

- Superior light for fresh water planted aquarium
- Enhance photosynthesis
- Induce plant growth
- >80% increase in power & brightness
- Bring out the natural colour of aquarium plants, especially green & red



Code No	Specification	Packing
LT0400	24 W - 22" / 550mm	25 pieces/carton
LT0405	39 W - 34" / 850mm	25 pieces/carton
LT0409	54 W - 46" / 1150mm	25 pieces/carton
LT0414	80 W - 58" / 1450mm	25 pieces/carton

VFR VIOLET FUSION RED

- Perfect light for tropical aquarium and fresh water planted aquarium
- Brings out the best colour of arowana
- Intensify the colour of fishes, especially red
- Induce photosynthesis & plant growth



Code No	Specification	Packing
LT185	10 W - 12"	25 pieces/carton
LT186	15 W - 18"	25 pieces/carton
LT191	38 W - 42"	25 pieces/carton





TITAN G3

HEAVY-DUTY AQUARIUM HEATER

ERROR INDICATOR	DOUBLE HEATING UNITS	TEMPERATURE PRECISION
FOR FRESH & SALT WATER	SHATTER-RESISTANT QUARTZ GLASS	
LED WATER TEMPERATURE DISPLAY	AUTOMATIC CONSTANT TEMPERATURE	
DUAL TEMPERATURE SENSOR PROBES		

Features :

- Dual temperature sensor probes**
 Designed using dual temperature sensor probes, providing dual protection for the heater and high safety temperature control.
- Double Heating Units**
 Twin heater units with a single control panel and thermostat give users more precision, greater response and control.
- Shatter-Resistant Quartz Glass**
 Shatter-resistant quartz glass tube makes this heater safe for all users as well as your aquarium livestock. This unit is waterproofed with double inner sealing designed to prevent water and electrical leakage.
- LED Water Temperature Display**
 Built-in LED unit displays current water temperature allowing you to monitor water temperature at a glance.
- Temperature Precision**
 The electric sensors allow you to control the water temperature in your aquarium with increased precision.
- Safety Auto-off**
 AZ[®] TITAN turns off automatically when it is removed from water or when water temperature exceeds 34°C.
- Error Display and Alarm**
 Alarm will activate with "HH" Error display when water temperature is more than 34°C or when heater is above water level. Heater will revert to normal when the problem is solved.



- 1 LED DISPLAY
- 2 CONTROL BUTTON
- 3 TEMPERATURE CONTROL
- 4 HEATING INDICATOR LIGHT
- 5 SPECIAL QUARTZ GLASS
- 6 HEATER GUARD
- 7 STRONG SUCTION

Code No.	Description	Watt (W)	Tank Size (Litre)	Packing
HT119	Titan G3	600	200 - 600	12 pieces/carton
HT120	Titan G3	800	400 - 800	12 pieces/carton
HT121	Titan G3	1000	500 - 1000	12 pieces/carton
HT122	Titan G3	1200	600 - 1200	12 pieces/carton
HT123	Titan G3	1500	800 - 1500	12 pieces/carton

DOUBLE - G3 HEATER

- Dual Temperature Sensor Probes
- Heat Shock and Heat Crack Proof
- Auto Cut Off System
- Temperature Error Alert
- Over Heating Protection
- Double Sensors

Features:

1. Designed using dual temperature sensor probes, providing dual protection for the heater and high safety temperature control.
2. The LED Digital Controller's features water temperature monitoring as well as temperature control functions; it features an all-electronic circuit that keeps the heating pipe and controller separated.
3. The LED Digital Controller features an imported microcomputer chip that controls the temperature, providing accurate sensing temperature and maintaining stable temperature. Dual LED Digital display provides easy temperature reading. The single button control provides easy setting.
4. Built-in protection measures:
 - a) Water temperature sensor; when water temperature reaches the set temperature, heating will stop. The quartz heating rod stops heating when out of water to prevent bursting and resumes heating when cooled.
 - b) Over-Heating protection: when temperature exceeds 36°C, HH will be displayed and heating stops.
 - c) When water temperature deviates far from the set temperature, an Alarm will sound and the temperature display blinks.
 - d) Dual Sensors for enhanced accuracy and safety. When the temperature difference between the two sensors is big, SS will be displayed and heating stops.
5. Uses the same ultra-heat-resistant silica tube used by "Corning Ware" from the U.S; ability to resist heat over 1000°C; prevents bursting of the external tube due to sudden changes in temperature caused by water-changes or heating without water added. It is truly burst proof and comparable to quality German thermostat; ensures long life performance an very safe.
6. Relay is used therefore not causing electromagnetic interference to other equipment or organism. Built-in temperature sensor make the heater easy to install and aesthetically pleasing in your aquarium; heating tube automatically stops heating when out of water, and auto-starts when submerged thus enabling full protection.
7. Uses a high quality heating coil that provides quick heating.



Code No.	Description	Watt (W)	Compact in Size (L)	Packing
HT104	Double-G3	50	18cm	24 pieces/carton
HT105	Double-G3	100	24cm	24 pieces/carton
HT106	Double-G3	200	28cm	24 pieces/carton
HT107	Double-G3	300	31.5cm	24 pieces/carton
HT108	Double-G3	500	41 cm	24 pieces/carton

AZ LED DISPLAY AQUARIUM HEATER

- LED WATER TEMPERATURE DISPLAY
- FOR FRESH & SALT WATER
- PRECISE TEMPERATURE CONTROL
- MAINTENANCE FREE
- ROBUST CONSTRUCTION
- SPECIAL SHATTER - RESISTANT SAFETY GLASS
- ENERGY SAVING

AZ LED Aquarium Heater is made with novice and expert fish hobbyist in mind. Designed with the latest precise temperature control technology and highest quality materials, you cannot go wrong with AZ LED Aquarium Heater. Temperature control is accurate and consistent ensuring all your aquatic friends are in safe hands. All it takes is to set your desired temperature with the temperature control dial, fixed provided Heater Guard, submerge and fasten AZ LED in the tank and it is that simple. AZ LED will maintain desired temperature throughout and you will have absolutely nothing to worry about.

- This heater is made with special high temperature shatter-resistant quality quartz glass tube. The glass tube can be held intact even with extreme temperature changes. This ensures safety to users as well as your aquarium livestock. Made totally water proofed with double inner sealing design to prevent water and electrical leakage.
- High instant heating capability as the heating element is made from high quality heating wire which is durable, instant heat transmission and has long life span. This product is energy saving too and environmentally friendly.
- This product is being tested over a span of period with positive result as a reliable aquarium temperature control unit. The temperature range is from 16°C to 32°C.



Code No	Description	Specification	Packing
HT047	LED Display Aquarium Heater	100 W	24 pieces/carton
HT048	LED Display Aquarium Heater	200 W	24 pieces/carton
HT049	LED Display Aquarium Heater	300 W	24 pieces/carton
HT050	LED Display Aquarium Heater	400 W	24 pieces/carton
HT051	LED Display Aquarium Heater	500 W	24 pieces/carton

PROFESSIONAL HEAT PACK

Ocean Free Professional Heat Pack is made from special selected raw material under the process of latest technology. This product is able to provide heating needs up to 40hrs time span. Each and every Heat Pack is also processed under stringent quality control measures before releasing from production.

- For shipping of tropical fishes
- Also for edible / other fish shipment use
- Applicable for other general use as well



Code No	Specification	Packing
AA039	40 hours	240 pieces/carton

ECO AQUARIUM HEATER

- HEAT RESISTANCE GLASS
- ACCURATE TEMPERATURE
- ENERGY SAVING
- SUPERIOR DESIGN
- FRESH & SALT WATER
- FAST HEATING

Fully automatic and adjustable aquarium heater for up to 75L. Water temperature is fully in consistent and heat is evenly distributed throughout. Easy to use even for novice fish hobbyist.

- Automatically maintains temperature selected throughout the tank
- Reliable and steadily built structure guarantees effectiveness
- Temperature dial is easy to read and set
- Special adhesive suckers and clip to keep heater in place firmly
- Special glass tube is highly resistant against heat and shock
- Visible ON / OFF indicator lamp
- Totally submersible in tank
- Suitable for tropical or marine tanks



HT046 HT045 HT044 HT043 HT042 HT064A

Code No	Description	Specification	Packing
HT064A	ECO Aquarium Heater	25 W	48 pieces/carton
HT042	ECO Aquarium Heater	50 W	48 pieces/carton
HT043	ECO Aquarium Heater	100 W	48 pieces/carton
HT044	ECO Aquarium Heater	150 W	48 pieces/carton
HT045	ECO Aquarium Heater	200 W	48 pieces/carton
HT046	ECO Aquarium Heater	300 W	48 pieces/carton

FAN COOLING SYSTEM

An innovative system that brings down the temperature of aquaria tank by the use of propelling fans. The cooling effect is accomplished when heat escapes from water surface through evaporation. In all, an average of 3°- 4° C can be reduced. An economical and sleek product, as compared to conventional bulky water chillers.

- Multi-purpose (not only in the cooling effect but also enhance good air circulation)
- Compact and modern in concept
- Adjustable to suit any fan angle
- Total silent operation and durable
- Practical and economical
- Available in different sizes to suit all tank sizes
- Energy saving
- Easy installation
- Maintenance Free



Code No	Specification	Packing
AA199	1 Fan	24 pieces/carton
AA200	2 Fan	12 pieces/carton
AA201	4 Fan	12 pieces/carton
AA202	6 Fan	12 pieces/carton

CO₂ PIPE HOLDER

- OF Pipe Holder prevents the CO₂ hose from bending and thus improving the air flow
- OF Pipe holder can be used individually or be attached to the glass tank



Code No.	Description	Packing
PM210	CO ₂ Pipe Holder	48 pieces/carton

CO₂ ESSENTIAL REGULATOR

- Unique air fastening design. No tools required to fasten it to the CO₂ cylinder
- Skillfully designed CO₂ flow regulator dial allows smooth and precise control
- Easy assembly



Code No.	Description	Packing
PM221	CO ₂ Essential Regulator	60 pieces/carton

CO₂ BUBBLE COUNTER

OF CO₂ bubble counter is made from high quality acrylic material that can withstand the high acidity of CO₂ to enhance the durability of the casing. Built-in check valve prevent water back flow due to gravitational force when the CO₂ regulator power supply is cut off or when the CO₂ cylinder is empty as it will create a vacuum within the cylinder.



Code No.	Description	Packing
PM215	CO ₂ Bubble Counter	48 pieces/carton

CO₂ REGULATOR & CO₂ SOLENOID REGULATOR

- Duo pressure gauge for accurate reading
- Easy assembly
- Bubble counter included
- Air pressure fastening design. No tools required in fastening to the CO₂ cylinder
- Built-in depressurize valve to achieve constant and precise CO₂ injection



Code No.	Description	Packing
PM216	CO ₂ Regulator	24 pieces/carton
PM217	CO ₂ Solenoid Regulator	12 pieces/carton

PM217

CO₂ DIFFUSER

- Using high quality ceramic, OF Diffuser disperses the finest CO₂ bubbles which enable the CO₂ to be diffused quickly into the water
- The unique design ensures easy cleaning during maintenance, and also while changing the ceramic disk
- CO₂ hose is attached at a vertical position to prevent the hose from bending and helps improve the air flow efficiency
- Slim and flat design enables hobbyist to attach the diffuser at the bottom of the aquarium to maximize the diffusing results
- High quality silicate suction cup ensures reliable and firm attachment



PM0229



PM0230



Code No.	Description	Packing
PM0229	CO ₂ Diffuser - Flat	48 pieces/carton
PM0230	CO ₂ Diffuser - Straight	48 pieces/carton

SPECIAL MULTI-STAGE CERAMIC CO₂ DIFFUSER

- High quality ceramic CO₂ diffuser
- Fine bubble diffusing capability
- Long lasting and easy to set up
- Suitable for beginner to expert use

Code No	Specification	Packing
PM068	Large	80 pieces/carton
PM069	Medium	50 pieces/carton



PM068

PM069

MULTI-PURPOSE PLANTING/CUTTING / FEEDING TONGS (STAINLESS STEEL)

- Easy to use planting tongs / cutting kit for planting or trimming purposes of all aquarium plants
- Can be used for the feeding of semi-aquatic / reptilian pets
- Made with stainless steel to last for a long time
- Ergonomically designed for steady holding



PM081



PM082



PM093



PM167



PM181

Code No.	Description	Packing
PM081	Multi-Purpose P/C Kit-25cm	50 pieces/carton
PM082	Multi-Purpose P/F Tongs-25cm	100 pieces/carton
PM093	Multi-Purpose Aquatic Plant Cutter-25cm	100 pieces/carton
PM167	Angle Tip P/F Tong-27cm	100 pieces/carton
PM181	Multi-Purpose P/F Tongs-38cm	100 pieces/carton

AQUA GRO PLANTS & SHRIMP SOIL

Aqua Gro Plants & Shrimp Soil is a substrate specially developed for aquatic plants and shrimps that need specific nutrients for growth. It is all natural and highly recommended for enthusiasts who want to grow their aquatic plants and shrimps well. Aqua Gro is produced using a special formulation which assists in lowering the pH and kH in a short period of time and maintaining it. As a result, it creates a natural water environment suitable for the aquatic plants and shrimps. In addition, the natural conditions created by Aqua Gro Soil makes it suitable for most tropical fishes too.



PM218

PM219

PM220

Code No	Specification	Packing
PM218	1 Litre	24 bags/carton
PM219	3 Litre	8 bags/carton
PM220	8 Litre	3 bags/carton

ECONOMY PLANT CO₂ SET

- Full start up kit set for aquarium planting purposes
- All in one with high quality stainless steel canister and accompanied with other planting accessories
- Fertilizer included



Code No.	Specification	Packing
PM091	8-in-1	individual

HIGH CLASS ECONOMY PLANT CO₂ SET

- Full start up kit set for aquarium planting purposes
- All in one with high quality alloy canister and accompanied with other planting accessories
- Fertilizer included



Code No.	Specification	Packing
PM092	9-in-1	individual

CARBON STEEL CO₂ CYLINDER

- High quality carbon steel CO₂ cylinder for long term usage
- Made with long lasting material and will not corrode



Code No.	Specification	Packing
PM083	2 litres	individual
PM084	3 litres	individual
PM085	5 litres	individual

P1-ABSOLUTE LIQUID FERTILIZER

(GREEN AQUATIC PLANT)

- Improve, balance and speed up the growth of the plants
- Enhance photosynthesis capability
- Improve growth of roots, stems and leaves
- Provide absolute basic water plants nutrients
- Maintain long term fertilizing effect and stabilizing water condition

Code No.	Specification	Packing
PM151	Liquid-50ml	96 bottles/carton
PM116	Liquid-120ml	48 bottles/carton
PM117	Liquid-250ml	36 bottles/carton
PM118	Liquid-1000ml	10 bottles/carton



PM151 PM118 PM116 PM117

P2-ABSOLUTE LIQUID FERTILIZER

(RED AQUATIC PLANT)

- Improve growth of red aquatic plants
- Provide all essential red plant nutrients
- Speedily and effectively aids formation of red chlorophyll
- Activate red plant enzymes
- Maintain long term bright red of the plants

Code No.	Specification	Packing
PM152	Liquid-50ml	96 bottles/carton
PM119	Liquid-120ml	48 bottles/carton
PM120	Liquid-250ml	36 bottles/carton
PM121	Liquid-1000ml	10 bottles/carton



PM152 PM121 PM119 PM120

P3-ABSOLUTE IRON SUPPLEMENT

- Help to enhance formation of green chlorophyll and nutrient absorption
- Making plant stem sturdy, broader and thicker leafed
- Improve the green for green plants and the red for red leafed plants
- Prevent plants turning sickly white, yellowish and eventual perishing from the tank
- Provide the essential iron supplement for the plants in the tank

Code No.	Specification	Packing
PM153	Liquid-50ml	96 bottles/carton
PM122	Liquid-120ml	48 bottles/carton
PM123	Liquid-250ml	36 bottles/carton
PM124	Liquid-1000ml	10 bottles/carton



PM153 PM124 PM122 PM123

P4-ABSOLUTE TRACE ELEMENTS

- To provide the tank with different minerals and trace elements
- Prevent plants from shortening, contracted and decaying of the roots
- Rejuvenating of the water quality and assist in stabilizing PH readings in tank
- To promote Enzyme that is essential for all plant
- This product also serves to benefit the color development, health and overall beauty of the fishes in the tank

Code No.	Specification	Packing
PM154	Liquid-50ml	96 bottles/carton
PM125	Liquid-120ml	48 bottles/carton
PM126	Liquid-250ml	36 bottles/carton
PM127	Liquid-1000ml	10 bottles/carton



PM154 PM127 PM125 PM126

P5-ABSOLUTE ALGAE REMOVER

- Remove and control all algae types
- Reduce Phosphate Salt and Nitrate Salt content
- Reduce PH value to the acidic range



PM155 PM128 PM129

Code No.	Specification	Packing
PM155	Liquid-50ml	96 bottles/carton
PM128	Liquid-120ml	48 bottles/carton
PM129	Liquid-250ml	36 bottles/carton

P6-ABSOLUTE SNAIL REMOVER

- Removes snails / juvenile snails, leeches and kills snail eggs
- Removes larvae of parasites
- Can be use as a effective anti-snail treatment for new plants purchased



PM156 PM131 PM132

Code No.	Specification	Packing
PM156	Liquid-50ml	96 bottles/carton
PM131	Liquid-120ml	48 bottles/carton
PM132	Liquid-250ml	36 bottles/carton

P7-ABSOLUTE PLANT VITAMIN COMPLEX

- Absolute vitamin supplement for aquatic plants
- Stabilize water aquatic cycle
- Prevent leaves of aquatic plants from turning yellow, leaf drop or developing of holes
- Lighting need enhancement (if lighting requirement is not sufficient)
- Improve organ functionality and improve plant branching
- Improve fish coloration, disease prevention, activeness and appetite



PM157 PM136 PM134 PM135

Code No.	Specification	Packing
PM157	Liquid-50ml	96 bottles/carton
PM134	Liquid-120ml	48 bottles/carton
PM135	Liquid-250ml	36 bottles/carton
PM136	Liquid-1000ml	10 bottles/carton

P9-ABSOLUTE BASE + BASE BOOSTER

- Increase effectiveness of any plant base by the double
- Can be used as a booster and also as base fertilizing, a multi-purpose product
- Also contain essential mineral and trace elements for the planted environment
- Makes plants thicker and healthier
- Provide a superior environment for the planted tank



PM139

Code No.	Specification	Packing
PM139	Pellet-50g	50 bottles/carton

P10-ABSOLUTE PLANT BALL FERTILIZER

- Enhance the plants against "colds"
- Doubling photosynthesis and rejuvenating plants
- For nurturing of plants to have broader and greener leaves
- To bring back the plants to the state as if they are in the natural environment



PM140

Code No.	Specification	Packing
PM140	Ball-25pcs	50 bottles/carton

P11-ABSOLUTE ROOT STICK

- Rejuvenating the plant base and bring back vitality to the plants
- Directly supply nutrients to the root of the plants
- Plant will grow healthier, making the leaf broader, thicker and greener therefore enhancing photosynthesis



PM141

Code No.	Specification	Packing
PM141	Stick-20pcs	50 bottles/carton

P12-ABSOLUTE PLANT BASE

- Provide long term stable plant base
- Assist in PH stabilizing
- Made under special formulation, new plants can easily absorb nutrients from the roots and stems
- Rich in essential nutrient elements and minerals
- Contain special ammoniac salt and control growth. Also enhance leaf growth and stronger root and stem formation.



PM142



PM143

Code No.	Specification	Packing
PM142	Soil / Sand-1.5kg	12 boxes/carton
PM143	Soil / Sand-5kg	individual



P13-ABSOLUTE PLANTING SOIL

- Long term effectiveness. This product can slowly release the nutrients for the roots of the plants more than a 12 months period
- Product is made of natural non-polluted fertile soil as raw material which is also fortified with essential minerals, trace elements and nutrients
- This plant soil had gone through special cleaning technology which makes it clean for immediate usage in the tank
- The plant soil is made into special size / shape and also able to buffer the water to perfect PH. This product also has high porosity surface that encourage good beneficial bacterial colony and the size / shape is made for good rooting of the plants. Additionally, water is able to pass through this plant soil with ease to encourage good dissolve oxygen exchange
- This plant soil will buffer the PH readings to the range of 6.5 - 7.0 which is considered to be of slight acidity. A good environment to control algae growth and also suitable for most aquatic plants, Discus, Tetras, River Fishes and other soft water environmental fishes
- Good media to maintain the PH reading to stable 6.5 - 7.0 range that is ideal environment for plants and fishes. Also a good media for the nurture of beneficial bacterial
- Due to its natural shape / color, the tank will look a lot more natural and brings on visual to the tank



PM198

PM175

Code No.	Specification	Packing
PM175	Black Soil-1.5kg	12 boxes/carton
PM198	Black Soil-8kg	3 packets/carton

P14-ABSOLUTE CO₂ TABLETS

- Provide daily CO₂ requirement
- Assist in CO₂ photosynthesis process
- Enhance aquatic plant size and hasten the growth
- Allow CO₂ to be more common and readily to be used for medium / small tanks

Code No.	Specification	Packing
PM177	Tablets-48pcs	50 boxes/carton



PM177



QIAN HU PROBIOTIC 1 & 2 - Koi Fish

is a probiotic enzyme carefully developed by OF® over the years. It combines many years of aquatic farming and biological research experience, and uses new technology to formulate and produce. It is used on our own fish farm for extensive field testing, and also tested together with famous koi farmers. After much extensive testing and research, the product is finally completed and we strongly recommend it to all professional koi fish farms and hobbyists.



QIAN HU PROBIOTIC 1

Fish Digestive Specialist & Good Water Quality Guardian

It is composed of a group of different probiotics with different superior advantages. The probiotics have different functions, complementing each other and form a very powerful probiotic in water. Each probiotic produces its own enzymes to further break down the different nutrient sources of the fish feed, making it easier for koi fish to digest and absorb. Therefore, koi's digestive intestinal problems can be well resolved. Qian Hu Probiotic 1 not only helps in resolving digestive problem, but also can effectively increase the fish's absorption rate. Spray it on the fish feed and feed to the koi fishes, and you will soon notice its effect in improving their appetite. Its growth rate can also be effectively improved.

Code No.

WC232
WC233
WC234

Specification

Liquid - 1000ml
Liquid - 2000ml
Liquid - 5000ml

Packing

10 bottles/carton
8 bottles/carton
Individual



QIAN HU PROBIOTIC 2

Water Quality Processing Specialist

A group of water quality probiotic strains specially developed by OF® targeted for water quality conditioning. It is different from ordinary photosynthetic nitrifying bacteria or probiotics. Qian Hu Probiotic 2 is a specially selected high-quality, dominant and elite group of beneficial bacteria strains, ensuring that each probiotic is highly active, with the ability to work and reproduce in stressful environments. Qian Hu Probiotic contains three habitual bacteria group : aerobic, anaerobic, and facultative bacteria, which can individually perform their unique functions in different aquatic environments, and are far superior than ordinary nitrifying and photosynthetic bacteria. The highly concentrated agent contains more than 2.5 billion bacteria in 1ml of liquid, to ensure sufficient number of probiotics is available to work and improve water quality.

Code No.

WC235
WC236
WC237

Specification

Liquid - 1000ml
Liquid - 2000ml
Liquid - 5000ml

Packing

10 bottles/carton
8 bottles/carton
Individual

QIAN HU PROBIOTIC 1 - Tropical Fish

Fish Digestive System Expert & Water Quality Treatment

It is composed of a group of different probiotics (more than 10 strain types) with different superior advantages. The probiotics have different functions, complementing each other and form a very powerful probiotic in water. Each probiotic produces its own enzymes to further break down the different nutrient sources of the fish feed, making it easier for Tropical fish to digest and absorb. Therefore, tropical fishes' digestive and nutrients absorption issues can be well resolved. Qian Hu Probiotic 1 not only helps in resolving digestive problem, but also can effectively increase the fish's absorption rate. Spray it on the fish feed and feed to the tropical fishes, and you will soon notice its effect in improving their appetite. Its growth rate can also be effectively improved.

Code No.	Specification	Packing
WC245	Liquid - 120ml	48 bottles/carton
WC246	Liquid - 250ml	36 bottles/carton
WC247	Liquid - 1000ml	10 bottles/carton



WC247

WC246

WC245

QIAN HU PROBIOTIC 2 - Tropical Fish

Professional Water Quality Treatment

Is a group of water quality probiotic strains (more than 8 strain types) specially developed by OF® targeted for water quality conditioning. It is different from ordinary photosynthetic nitrifying bacteria or probiotics. Qian Hu Probiotic 2 is a specially selected high-quality dominant and elite group of beneficial bacteria strains, ensuring that each probiotic is highly active, with the ability to work and reproduce in stressful environments. Qian Hu Probiotic 2 contains three habitual bacteria group: aerobic, anaerobic, and facultative bacteria, which can individually perform their unique functions in different aquatic environments, and are far more superior than ordinary nitrifying and photosynthetic bacteria. The highly concentrated agent ensure sufficient number of probiotics is available to work and improve water quality.

Code No.	Specification	Packing
WC248	Liquid - 120ml	48 bottles/carton
WC249	Liquid - 250ml	36 bottles/carton
WC250	Liquid - 1000ml	10 bottles/carton



WC250

WC249

WC248

QIAN HU PROBIOTIC 3

The Expert in Protecting & Rectifying Fish's Intestines & Digestive System (improve & increases appetite)

A super intestinal probiotics developed by OF® over many years, especially targeted for the intestines and digestive system of fish. It adopts the latest technology and special production process that requires to go through multiple stages to be completed. It is unique and extraordinary effective. In addition to making good use of our own fish farms for in-depth and extensive field experiments, we also invite top fish farms in many regions to conduct experiments together to perfect the product. We now share this result with all the professional fish farms and hobbyists.

Code No.	Specification	Packing
WC242	Liquid - 120ml	48 bottles/carton
WC243	Liquid - 250ml	36 bottles/carton
WC244	Liquid - 1000ml	10 bottles/carton
WC276	Liquid - 2000ml	8 bottles/carton



WC276

WC242

WC243

WC244

BETTA MEDICATION SERIES



BETTA CURE HERBAL SUPPLEMENT

Introduction:

OF® Betta Cure encompass high curing rate made totally from plant extraction. Absolutely no side effects, none polluting to the environment and save to use product even if overdosed. This is a miracle must have product for all Betta hobbyist and usage over a period of time increases disease resistance and provides nutritional and immunological boost.

OF® Betta Cure is a special herbal blend of various herbs which perform 5 main disease prevention and treatment at the same time as : 1) Bactericide, 2) Parasitic, 3) Fungicide, 4) Gill Disease cure and 5) unknown diseases. All that is needed to do is just to dose the recommended dosage and 90% of all found diseases can be in the scope of treatment. This secret formula solely owned by OF® increases Betta fish survival rate in tanks and a must have product for all Betta fish keepers.



BETTA WATER GUARD

Introduction:

In recent times, a lot of harmful bacteria / parasite is becoming resistant to conventional water treatment chemicals and had evolved to be suited in the treated environment. Normal or conventional water treatment has lost its effectiveness as such and this resulted to the use of even stronger water treatment chemicals to kill these bacteria/parasite found in our daily consumption water.

OF® recognize this problem and therefore intense research is carried out to rectify this problem using dense water treatment experience and also high technology assistant to derive the Betta New Water Guard.

OF® Betta Water Guard also assist in removing heavy metals and toxic chemicals as well as effectively suppress the growth of harmful bacteria and parasite. It helps protect the Betta fishes gills and reduce the stress factor by assisting the Betta fishes produce natural protective slime on their body, therefore creating the most ideal aquarium environment.



BETTA SUPER NATURAL BLACK WATER

Introduction:

"OF® Betta Super Natural Black Water" is specially formulated from extracts of natural swamp peat, root, bark wood, humic acid, special leaves and most importantly, it contains more than 30 stable essential trace element, minerals & water soluble vitamins which replicate and enhances the natural water condition essential to achieve the optimal growth and proper Betta fishes keeping.

With our special concoction, it also has antimicrobial, anti-oxidant and immuno-boosting abilities. The light-brown natural colour texture mimics the Betta fishes' natural environment thus providing a conducive environment for breeding & finest growth while encouraging the speedy cultivation of beneficial bacteria. This product is harmless to all fishes and aquatic plants.

Code No.

MD471

MD472

MD473

Description

Betta Cure Herbal Supplement

Betta Water Guard

Betta Super Natural Black Water

Specification

Liquid - 20ml

Liquid - 20ml

Liquid - 20ml

Packing

60 pieces/carton

60 pieces/carton

60 pieces/carton

A-PRO FISH GUARD

- Removes chlorine, chloramine & heavy metals
- Contains Aloe Vera, Vitamins E & B
- Buffers PH and reduces stress
- Stimulates protective slime
- Creates superior water quality
- Protects mucus & gills

Code No.	Specification	Packing
PROA50ML	Liquid-50ml	48 bottles/carton
PROA120ML	Liquid-120ml	48 bottles/carton
PROA250ML	Liquid-250ml	36 bottles/carton
PROA1L	Liquid-1000ml	10 bottles/carton



B-PRO GREEN AWAY

For fast solving of green water problems for aquariums, ponds or fountains

Code No.	Specification	Packing
PROB50ML	Liquid-50ml	48 bottles/carton
PROB120ML	Liquid-120ml	48 bottles/carton
PROB250ML	Liquid-250ml	36 bottles/carton
PROB1L	Liquid-1000ml	10 bottles/carton



C-PRO CRYSTAL CLEAR

- Solves cloudy water problems and making water crystal clear
- Removes excessive phosphate

Code No.	Specification	Packing
PROC50ML	Liquid-50ml	48 bottles/carton
PROC120ML	Liquid-120ml	48 bottles/carton
PROC250ML	Liquid-250ml	36 bottles/carton
PROC1L	Liquid-1000ml	10 bottles/carton



D-PRO INTERNAL BACTERIA & ULCER AWAY

For the use to treat diseases such as Ulcer, Blood Streaks, Dropsy, Abdominal Swelling, Bacterium related gill rot.

Code No.	Specification	Packing
PROD50ML	Liquid-50ml	48 bottles/carton
PROD120ML	Liquid-120ml	48 bottles/carton
PROD250ML	Liquid-250ml	36 bottles/carton
PROD1L	Liquid-1000ml	10 bottles/carton



E-PRO EXTERNAL BACTERIA & FUNGUS AWAY

Treats diseases like Cotton wool disease, fungus, ragged fins, fin rot, mouth rot etc

Code No.	Specification	Packing
PROE50ML	Liquid-50ml	48 bottles/carton
PROE120ML	Liquid-120ml	48 bottles/carton
PROE250ML	Liquid-250ml	36 bottles/carton
PROE1L	Liquid-1000ml	10 bottles/carton



F-PRO SLIME, WHITE SPOT & VELVET AWAY

Treats diseases like white spot, gill flukes, slime & velvet disease organisms

Code No.	Specification	Packing
PROF50ML	Liquid-50ml	48 bottles/carton
PROF120ML	Liquid-120ml	48 bottles/carton
PROF250ML	Liquid-250ml	36 bottles/carton
PROF1L	Liquid-1000ml	10 bottles/carton



PROF1L PROF120ML PROF50ML

G-PRO CHLORINE & CHLORAMINE AWAY

- Concentrated
- Super effective
- Removes chloramines
- Removes harmless chlorine instantly

Code No.	Specification	Packing
PROG50ML	Liquid-50ml	48 bottles/carton
PROG120ML	Liquid-120ml	48 bottles/carton
PROG250ML	Liquid-250ml	36 bottles/carton
PROG1L	Liquid-1000ml	10 bottles/carton



PROG1L PROG120ML PROG50ML

H-PRO PH-DOWN

- Safest & natural way to decrease pH value
- Increase acidity
- Special buffer compound added in to maintain the pH value even longer

Code No.	Specification	Packing
PROH50ML	Liquid-50ml	48 bottles/carton
PROH120ML	Liquid-120ml	48 bottles/carton
PROH250ML	Liquid-250ml	36 bottles/carton



PROH120ML PROH250ML

I-PRO PH-UP

- Increase alkalinity
- Special buffer compound added in to maintain the pH value even longer
- Safest & most natural way to increase pH value

Code No.	Specification	Packing
PROI50ML	Liquid-50ml	48 bottles/carton
PROI120ML	Liquid-120ml	48 bottles/carton
PROI250ML	Liquid-250ml	36 bottles/carton



PROI120ML PROI250ML

J-PRO DISEASE AWAY

- Prevents & act against an extensive range of diseases caused by organisms
- Improves water quality by oxidation of the dissolved and suspended organic materials

Code No.	Specification	Packing
PROJ50ML	Liquid-50ml	48 bottles/carton
PROJ120ML	Liquid-120ml	48 bottles/carton
PROJ250ML	Liquid-250ml	36 bottles/carton
PROJ1L	Liquid-1000ml	10 bottles/carton



PROJ1L PROJ120ML PROJ250ML

K-PRO COPPER SAFE

- Treats & prevents external parasites like Anchor Worms, Lice, Flukes, Itch, Velvet Diseases etc
- Concentrated • Safe • Effective

Code No.	Specification	Packing
PROK50ML	Liquid-50ml	48 bottles/carton
PROK120ML	Liquid-120ml	48 bottles/carton
PROK250ML	Liquid-250ml	36 bottles/carton
PROK1L	Liquid-1000ml	10 bottles/carton



L-PRO BLACK WATER

- Enhance fish coloration
- Stress reduction
- Better environment for live plants
- Creates healthy environment
- Aids breeding
- Builds up fish resistance
- Retards algae growth

Code No.	Specification	Packing
PROL50ML	Liquid-50ml	48 bottles/carton
PROL120ML	Liquid-120ml	48 bottles/carton
PROL250ML	Liquid-250ml	36 bottles/carton
PROL1L	Liquid-1000ml	10 bottles/carton



M-PRO VITAMIN COMPLEX

OF Vitamin Complex is the most stable and complete multi-vitamin complex in the market. It contains all the essential vitamins for all aquatic live form. It also encompasses calcium with trace elements / minerals added. Through high technology processing. It is highly absorbable through fish's mouth, gills and skin. This is a 'must have' for all novice and expert hobbyist.

Code No.	Specification	Packing
PROM50ML	Liquid-50ml	48 bottles/carton
PROM120ML	Liquid-120ml	48 bottles/carton
PROM250ML	Liquid-250ml	36 bottles/carton
PROM1L	Liquid-1000ml	10 bottles/carton



N-PRO BATTLE BACTERIA

- Improves fish coloration
- Reduces stress
- Helps to establish ecological cycle
- Setting up new aquarium
- Increase fish resistance
- Enhances hatching
- Reduces algae growth
- Improves plants growth
- When changing water

Code No.	Specification	Packing
PRON50ML	Liquid-50ml	48 bottles/carton
PRON120ML	Liquid-120ml	48 bottles/carton
PRON250ML	Liquid-250ml	36 bottles/carton
PRON1L	Liquid-1000ml	10 bottles/carton



OF HERBAL T1-ANTI-BACTERIA

Natural Herbal Extract. Health Supplement.

- Non toxic & chemical-free. Safe for existing ecosystem
- Helps to reduce diseases related to bacteria influx
- Reduces pathogenic factors and nitrifies bacteria growth
- Conditions and stabilises water condition
- Non-lethal in event of over-dosage unlike chemical medications

Code No.	Specification	Packing
MD0546	Liquid-120ml	48 bottles/carton
MD0547	Liquid-250ml	36 bottles/carton
MD0548	Liquid-1000ml	10 bottles/carton
MD0549	Liquid-3.8litre	4 bottles/carton



OF HERBAL T2-ANTI-EXTERNAL PARASITE

Natural Herbal Extract. Health Supplement.

- Non toxic & chemical-free. Safe for existing ecosystem
- Helps to reduce diseases caused by external parasitical attack
- Reacts and gets rid of external parasites in a few days
- Non-lethal in event of over-dosage unlike chemical medications

Code No.	Specification	Packing
MD0550	Liquid-120ml	48 bottles/carton
MD0551	Liquid-250ml	36 bottles/carton
MD0552	Liquid-1000ml	10 bottles/carton
MD0553	Liquid-3.8litre	4 bottles/carton



OF HERBAL T3-ANTI-FUNGUS

Natural Herbal Extract. Health Supplement.

- Non toxic & chemical-free. Safe for existing ecosystem
- Helps to reduce diseases related to Fungus Infection
- Disinfects and protects fishes' skin
- Non-lethal in event of over-dosage unlike chemical medications

Code No.	Specification	Packing
MD0554	Liquid-120ml	48 bottles/carton
MD0555	Liquid-250ml	36 bottles/carton
MD0556	Liquid-1000ml	10 bottles/carton
MD0557	Liquid-3.8litre	4 bottles/carton



OF HERBAL T4-ANTI-GILL DISEASE

Natural Herbal Extract. Health Supplement.

- Non toxic & chemical-free. Safe for existing ecosystem
- Helps to reduce all gill diseases caused by exposure to concentrated chemical treatments, parasitical attacks or water pollutants
- Boost fishes' natural immune system
- Non-lethal in event of over-dosage unlike chemical medications

Code No.	Specification	Packing
MD0558	Liquid-120ml	48 bottles/carton
MD0559	Liquid-250ml	36 bottles/carton
MD0560	Liquid-1000ml	10 bottles/carton
MD0561	Liquid-3.8litre	4 bottles/carton



NATURE EARTH

Nature Earth introduces the wholesome goodness only found in the wild river-beds and natural water bodies into your home aquarium. A 100% natural extract from rich volcanic earth and river bed deposits formed through the ages, it contains trace mineral elements commonly lacking in home aquarium environment.

Features & Benefits:

- 100% natural and organic with minerals and trace elements.
- Naturally removes harmful heavy metal, chemicals and toxic substances.
- Clarifies water and stabilizes water conditions.
- Accelerates fish growth and strengthens overall health and immune system.
- Naturally intensifies fish coloration and scale shine.
- Rich source of essential minerals for aquatic plants without causing algae bloom.
- Contains active negative ions which binds harmful toxins into larger particles that can be effectively and safely removed through filtration.
- 100% safe and encourages cultivation of beneficial bacteria in aquarium.
- Creates a rich, natural and safe environment only found in wild when added periodically to aquarium.



Code No.	Description	Specification	Packing
WC200	For Fresh Water, Planted and Marine	85g	36 boxes/carton
WC201	For Fresh Water, Planted and Marine	260g	24 boxes/carton
WC202	For Arowana / Stingray only	260g	24 boxes/carton
WC203	For Arowana / Stingray only	550g	12 boxes/carton
WC204	For Cichlid only	260g	24 boxes/carton
WC205	For Ponds, Concrete Ponds and Koi Tanks	1.5kg	6 boxes/carton
WC206	For Ponds, Concrete Ponds and Koi Tanks	6kg	2 boxes/carton

CALIBRATION SOLUTIONS PH4 & PH7

pH probes require periodic calibration to ensure users continue to obtain accurate pH measurements. OF Calibration solutions pH 4 & pH 7 are specifically made to allow users to calibrate their probes to the highest possible accuracy.

Calibration should be performed with at least two standard buffer solutions. As pH 7 is essentially, a "zero point" calibration (similar to zeroing a scale or balance), calibration at pH 7 followed by calibration at pH 4 as the second point of reference will enable users to perform a more accurate two point calibration.



Code No.	Specification	Packing
AM048	Liquid-100mlx2	24 boxes/carton

TURTLE MEDICATION - EYE CLEAR

Tortoises and turtles get eye infection mainly due to unhygienic living conditions. On many occasion, it is fatal as they will not consume any food once they lose their vision, eventually leading to death. Once the chelonian is seen to have an infection, immediate treatment should be carried out to prevent further deterioration. Inflammation of the eyelids and the eye are characterized by bacterial overgrowth on the lids.



Code No.	Specification	Packing
MD351	Liquid-20ml	60 boxes/carton

TURTLE MEDICATION - BACTERIA & FUNGUS AWAY

Pet Tortoises are more prone to bacterial and fungal infections than many other reptilians as they are constantly in contact with their own fecal discharge in the aquarium environment. Inappropriate living environment and husbandry can result in infections.

If you suspect a mouth infection in your tortoise, or if there is significant soreness, inflammation, discharge, disfigurement in any parts of the animal, or if the reptile shows a decrease in activity or appetite, it is extremely important to take it to reptile veterinarian as soon as possible. It can be very difficult to treat infections after the bone and deeper tissues are affected.



Code No.	Specification	Packing
MD352	Liquid-20ml	60 boxes/carton

3RD GENERATION YELLOW POWDER

- Easy to use
- Kills both internal and external bacteria
- Safe and effective
- Will not cloud water

OF Unique "Yellow Powder" is the result of our long term commitment in R & D and the only Yellow Powder around that has a specialised formulation against both internal and external bacteria. Our Yellow Powder is not only very effective against skin lesions, it is even more effective against intestinal bacteria infection. Our OF Yellow Powder is effective against fin rot, gill rot, hemorrhagic septicemia, mild dropsy, skin lesions, bacterial infection of the digestive system and many other bacterial infections.

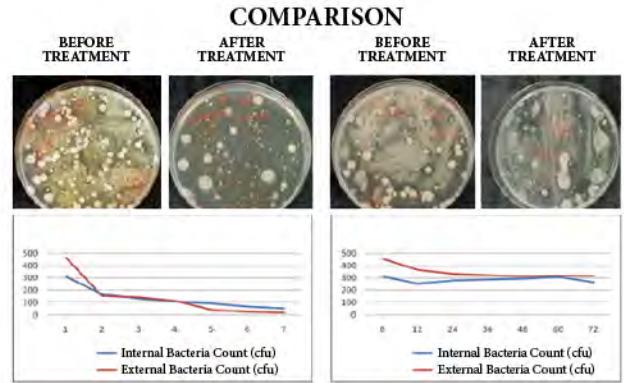

Code No.	Specification	Packing
MD207	5g	20 pieces/box / 400 pieces/carton
MD208	50g	36 bottles/carton
MD209	100g	24 bottles/carton
MD210	250g	18 bottles/carton
MD211	500g	12 bottles/carton
MD212	1000g	6 bottles/carton



YELLOW CAPSULES

- Easy to use
- Kills both internal and external bacteria
- Safe and effective
- Will not cloud water



Code No.	Specification	Packing
MD353	10 capsules/box	240 boxes/carton

MICROBAC

PRO - NITRO CYCLE FORMULATION CAPSULES - THE LEADING AQUARIUM BENEFICIAL BACTERIA

100% natural and organic with no harmful chemicals, safe for all live-stock. Suitable for Established or New Freshwater, Planted and Marine aquariums.

Microbac is a special formulation of beneficial bacteria, enzymes and micro-organism consisting of more than seven major bacteria species and strains (aerobic and anaerobic type) like yeast, nitrosomonas, nitrobacter, photosynthetic bacteria, and a special strain of beneficial bacteria. Advanced encapsulation methods allow the bacteria to be packed in concentrated form and activated upon contact with water.

Microbac is natural and organic, easy to use and livestock-safe; it is now widely accepted and used by fish breeders and both casual and serious hobbyist. No other product comes close.

Features & Benefits:

1. Effectively disintegrate ammonia, nitrite, nitrate and organic substances
2. Disintegrate organic waste like fish feces or left over fish food
3. Reduce B.O.D and C.O.D and increase the Oxygen
4. Effectively build a balance aquarium ecosystem
5. Prevent and reduce " Green Water " problems
6. Help to control pathogenic bacteria growth, effectively prevent some disease
7. Improve the performance of the filter / filtration system, cost saving
8. Strengthen photosynthesis, better and healthy plant growth
9. Improve immune system, reduce disease
10. Speedy regenerating aquatics plants / under gravel, to avoid " Dead Angle " in the tank or pond
11. Help to reduce protein, sludge, organic grease and rejuvenize pond soil
12. Maintain superior water quality for giant fish (carnivorous) like arowana, stingray, cichlid etc
13. Help in inducing the colour pigment of the fishes naturally
14. Stabilizing marine water quality
15. Contain special mineral, trace element, a secret toward successful marine tank
16. Extended shelf life and longer life span
17. Obtain from nature, environmental friendly and economical
18. Go through long term testing in laboratory / farm, very safe and reliable



MD335

MD336

MD337

MD338

MD339

Code No.	Description	Specification	Packing
MD335	For Arowana	30 capsules/box	72 boxes/carton
MD336	For Marine	30 capsules/box	72 boxes/carton
MD337	For Planted Tank	30 capsules/box	72 boxes/carton
MD338	For Koi	30 capsules/box	72 boxes/carton
MD339	For All Tropical Aquaria	30 capsules/box	72 boxes/carton

AROWANA ANTI-DROPSY / ANTI-CLOUDY EYE / ANTI-COLUMNARIS (FIN ROT) CAPSULES

- Specially formulated to treat Dropsy / Cloudy Eye / Columnaris (Fin Rot)
- Safe and effective
- Easy to use

The Asian Arowana or 'Dragon Fish' has long been regarded as a symbol of power, wealth and prosperity amongst the Chinese due to its striking resemblance to the Dragon. Immensely powerful yet elegant, it carries itself with an air of distinction and nobility that makes it highly sought after by hobbyists around the world.

However, even with the best man-made environment, differences still exist between conditions found in nature and in the aquarium. An Arowana, like any other creature, can easily be infected once its resistance to disease is low. It is important to recognize these symptoms early and treat them before they fester.

Qian Hu Corporation Limited with more than 20 years' experience of rearing and breeding Asian Arowana, would like to introduce the OF® Arowana Series of specialist treatments for some of the common diseases afflicting these majestic fishes.



MD357



MD358



MD359



Code No.

MD357
MD358
MD359

Description

Anti-Dropsy
Anti-Cloudy Eye
Anti-Columnaris

Specification

10 capsules/box
10 capsules/box
10 capsules/box

Packing

240 boxes/carton
240 boxes/carton
240 boxes/carton

PARACLEAR

The Anti-Internal Parasite and Bloat Treatment

- Gentle to fishes. Tough against Internal Parasites
- Effectively annihilate parasite eggs and passed out through feces
- Relieves stomach bloat and swell
- Suitable for all cichlids, especially Discus and Flowerhorn
- Improves fish appetite



Code No.	Specification	Packing
MD225	5g	20 pieces/box / 400 pieces/carton
MD226	50g	36 bottles/carton

SUPER NATURAL BLACK WATER

- 100% natural
- Contains Antioxidants / Anti-aging capabilities
- Aids plant growth
- More than 30 types of essential trace elements & vitamins
- Intensify fish coloration
- Retards and controls algae growth
- Improve immunity against diseases
- Creates an ideal & natural environment
- Soften water and enhance fish growth



Code No.	Specification	Packing
MD315	Liquid-120ml	48 bottles/carton
MD316	Liquid-250ml	36 bottles/carton
MD317	Liquid-500ml	12 bottles/carton
MD318	Liquid-1000ml	10 bottles/carton
MD319	Liquid-2000ml	8 bottles/carton
MD320	Liquid-3800ml	4 bottles/carton

PURE LIQUID

- The Revolutionary Breakthrough in Water Technology**
- 100% Natural with >25,000 Natural Minerals, Compounds & Elements
 - Significantly Improves Water Quality
 - Applicable for Planted, Freshwater, Marine & Reef Aquaria Tanks

"Pure Liquid" is an all natural water conditional with multiple active benefits for Marine & Freshwater aquaria. It aids bacterial cultivation, neutralizes harmful metals and water additives (such as Chlorine, Chloramines) and introduces more than 25,000 types of natural minerals, compounds and elements; thus creating an ideal natural water condition for your fishes, plants and corals.



Code No.	Specification	Packing
OFWC001	Liquid-100ml	48 bottles/carton
OFWC002	Liquid-250ml	25 bottles/carton
OFWC003	Liquid-500ml	16 bottles/carton
OFWC004	Liquid-2litre	8 bottles/carton

'0' ALGAE

- Safe for Livestock
- Easy to Use
- Effective
- No water change
- Fast Results
- Colorless

OF Zero Algae is the exciting new solution to your aquarium's algae problems. After extensive research and experiments with various algae types (Brown Algae, Green Algae, Red Brush Algae, Blue-Green Algae, Hair Algae and Beard Algae etc), OF Zero Algae is found to control Algae growth effectively and efficiently in a natural manner while ensuring that it is harmless to your livestock and most aquatic plants. Furthermore unlike traditional algacides, water change is unnecessary after dosing; saving aquarist much time and inconveniences.

Zero Algae works by damaging the essential enzymes needed by the algae for survival, thus killing off the algae. Generally, results can be observed after one cycle of treatment, when the algae turn whitish and start to die off after a couple of days. Hardier forms of algae will require approximately 7-14 days to die off. In the unlikely event that some algae remain, repeat the treatment 10 days after completing the first treatment cycle. As Zero Algae is harmless to beneficial bacteria, weekly dosage can be repeated to inhibit further algae growth.



Code No.	Specification	Packing
MD227	Liquid-50ml	48 bottles/carton
MD228	Liquid-125ml	48 bottles/carton
MD229	Liquid-250ml	36 bottles/carton

A-SUPER FISH GUARD

- Removes chlorine, chloramine & heavy metals
- Buffers PH and reduces stress
- Contains Aloe Vera, Vitamins E & B
- Stimulates protective slime
- Protects mucus & gills
- Creates superior water quality

Code No.	Specification	Packing
A120ML	Liquid-120ml	48 bottles/carton
A250ML	Liquid-250ml	36 bottles/carton
A1L	Liquid-1000ml	10 bottles/carton



A250ML

A120ML

A1L

B-SUPER GREEN AWAY

For fast solving of green water problems for aquariums, ponds or fountains

Code No.	Specification	Packing
B120ML	Liquid-120ml	48 bottles/carton
B250ML	Liquid-250ml	36 bottles/carton
B1L	Liquid-1000ml	10 bottles/carton



B250ML

B120ML

B1L

C-SUPER CRYSTAL CLEAR

- Solves cloudy water problems and making water crystal clear
- Removes excessive phosphate

Code No.	Specification	Packing
C120ML	Liquid-120ml	48 bottles/carton
C250ML	Liquid-250ml	36 bottles/carton
C1L	Liquid-1000ml	10 bottles/carton



C250ML

C120ML

C1L

D-SUPER INTERNAL BACTERIA & ULCER AWAY

For the use to treat diseases such as Ulcer, Blood Streaks, Dropsy, Abdominal Swelling, Bacterium related gill rot

Code No.	Specification	Packing
D120ML	Liquid-120ml	48 bottles/carton
D250ML	Liquid-250ml	36 bottles/carton
D1L	Liquid-1000ml	10 bottles/carton



D250ML

D120ML

D1L

E-SUPER EXTERNAL BACTERIA & FUNGUS AWAY

Treats diseases like Cotton wool disease, fungus, ragged fins, fin rot, mouth rot etc

Code No.	Specification	Packing
E120ML	Liquid-120ml	48 bottles/carton
E250ML	Liquid-250ml	36 bottles/carton
E1L	Liquid-1000ml	10 bottles/carton



E250ML E120ML E1L

NEW
IMPROVED
FORMULA

F-SUPER SLIME, WHITE SPOT & VELVET AWAY

Treats diseases like white spot, gill flukes, slime & velvet disease organisms

Code No.	Specification	Packing
F120ML	Liquid-120ml	48 bottles/carton
F250ML	Liquid-250ml	36 bottles/carton
F1L	Liquid-1000ml	10 bottles/carton



F250ML F120ML F1L

NEW
IMPROVED
FORMULA

G-SUPER CHLORINE & CHLORAMINE AWAY

- Super effective
- Removes harmless chlorine instantly
- Concentrated
- Removes chloramines

Code No.	Specification	Packing
G120ML	Liquid-120ml	48 bottles/carton
G250ML	Liquid-250ml	36 bottles/carton
G1L	Liquid-1000ml	10 bottles/carton



G250ML G120ML G1L

NEW
IMPROVED
FORMULA

H-SUPER PH-DOWN

- Special buffer compound added in to maintain the pH value even longer
- Safest & natural way to decrease pH value
- Increase acidity

Code No.	Specification	Packing
H120ML	Liquid-120ml	48 bottles/carton
H250ML	Liquid-250ml	36 bottles/carton



H250ML H120ML

NEW
IMPROVED
FORMULA

I-SUPER PH-UP

- Increase alkalinity
- Special buffer compound added in to maintain the pH value even longer
- Safest & most natural way to increase pH value

Code No.	Specification	Packing
I120ML	Liquid-120ml	48 bottles/carton
I250ML	Liquid-250ml	36 bottles/carton



NEW
IMPROVED
FORMULA

I250ML I120ML

J-SUPER DISEASE AWAY

- Prevents & act against an extensive range of diseases caused by organisms
- Improves water quality by oxidation of the dissolved and suspended organic materials

Code No.	Specification	Packing
J120ML	Liquid-120ml	48 bottles/carton
J250ML	Liquid-250ml	36 bottles/carton
J1L	Liquid-1000ml	10 bottles/carton



NEW
IMPROVED
FORMULA

J250ML J120ML J1L

K-SUPER COPPER SAFE

- Treats & prevents external parasites like Anchor Worms, Lice, Flakes, Itch, Velvet Diseases etc
- Concentrated • Safe • Effective

Code No.	Specification	Packing
K120ML	Liquid-120ml	48 bottles/carton
K250ML	Liquid-250ml	36 bottles/carton
K1L	Liquid-1000ml	10 bottles/carton



NEW
IMPROVED
FORMULA

K250ML K120ML K1L

L-SUPER BLACK WATER

- Enhance fish coloration
- Builds up fish resistance
- Retards algae growth
- Creates healthy environment
- Aids breeding
- Stress reduction
- Better environment for live plants

Code No.	Specification	Packing
L120ML	Liquid-120ml	48 bottles/carton
L250ML	Liquid-250ml	36 bottles/carton
L1L	Liquid-1000ml	10 bottles/carton



NEW
IMPROVED
FORMULA

L250ML L120ML L1L

M-SUPER MULTI-VITAMIN

- Stable and complete multi-vitamin complex in the market
- Contains all the essential vitamins for all aquatic live form
- Encompasses calcium with trace elements / minerals added
- Highly absorbable through fish's mouth, gills and skin

Code No.	Specification	Packing
M120ML	Liquid-120ml	48 bottles/carton
M250ML	Liquid-250ml	36 bottles/carton
M1L	Liquid-1000ml	10 bottles/carton



NEW
IMPROVED
FORMULA

M250ML M120ML M1L

SPECIAL AROWANA MEDICATION 1-9

- Complete range of Arowana medication for all types of ornamental aquatic diseases
- Proven effective and widely used by Arowana breeders, serious hobbyist and experts
- High safety density and effective
- For treatment and preventive purposes
- Water conditioning and health enhancement



Code No.

Description

Specification

Packing

MD125	Arowana Guard-1	Liquid-150ml	48 bottles/carton
MD126	Arowana Disease Away-2	Liquid-150ml	48 bottles/carton
MD127	Arowana External Bacteria & Fungus Away-3	Liquid-150ml	48 bottles/carton
MD128	Arowana Slime, White Spot & Velvet Away-4	Liquid-150ml	48 bottles/carton
MD129	Arowana Internal Bacteria & Ulcer Away-5	Liquid-150ml	48 bottles/carton
MD153	Arowana Stabilizer-6	Liquid-150ml	48 bottles/carton
MD154	Arowana Black Water-7	Liquid-150ml	48 bottles/carton
MD160	Arowana Vitamin Complex-8	Liquid-150ml	48 bottles/carton
MD161	Arowana Beneficial Bacteria 9000-9	Liquid-150ml	48 bottles/carton
MD197	Arowana Guard-1	Liquid- 500ml	12 bottles/carton
MD198	Arowana External Bacteria & Fungus Away-3	Liquid- 500ml	12 bottles/carton
MD199	Arowana Slime, White Spot & Velvet Away-4	Liquid- 500ml	12 bottles/carton
MD200	Arowana Internal Bacteria & Ulcer Away-5	Liquid- 500ml	12 bottles/carton
MD201	Arowana Black Water-7	Liquid- 500ml	12 bottles/carton
MD202	Arowana Vitamin Complex-8	Liquid- 500ml	12 bottles/carton
MD213	Arowana Beneficial Bacteria 9000-9	Liquid- 500ml	12 bottles/carton

SUPER VITAMIN COMPLEX (GENERAL)

Ocean Free Multi-Vitamin Complex is the most stable and complete multi-vitamin complex in the market. It contains all the essential vitamins for all aquatic live form. It also encompasses calcium with trace elements / minerals added. Through high technology processing. It is highly absorbable through fish's mouth, gills and skin. This is a 'must have' for all novice and expert hobbyist.



FV007 FV006 FV008

Code No.	Specification	Packing
FV006	Liquid-120ml	48 bottles/carton
FV007	Liquid-250ml	36 bottles/carton
FV008	Liquid-1000ml	10 bottles/carton

3RD GENERATION

- Complete range of powdered medication for all types of ornamental aquatic diseases
- High safety density, effective and easy to use
- For treatment and preventive purposes
- Widely used by Discus breeders, serious hobbyist and experts



MD142 MD143 MD144 MD145 MD146

Code No.	Description	Specification	Packing
MD142	Super Cure-1	Powder Foam-50g	90 bottles/carton
MD143	Super Anti-Disease-2	Powder Foam-50g	90 bottles/carton
MD144	Super Anti-External Parasites-3	Powder Foam-50g	90 bottles/carton
MD145	Super Anti-Internal Parasites-4	Powder Foam-50g	90 bottles/carton
MD146	Super Internal Tape-Line Worm-5	Powder Foam-50g	90 bottles/carton

A-Z SUPER BENEFICIAL BACTERIA

- Fast to establish (matured) a healthy pond / tank system. Avoid new tank syndrome
- Increase fish appetite, growth and colouring through superior water quality
- Reduce and control toxic ammonia, nitrites, nitrates and phosphorus
- Reduce organic debris (B.O.D) and improve water clarity
- Digest organic sediments at a control rate
- Greatly reduce the needs for changing water
- Control and eliminate stubborn algae
- Lower pond / tank scum and remove odors
- Solve green water problem naturally
- Can be used for old and new tank / pond
- Help to prevent fish diseases



MD026 MD027 MD028

Code No.	Specification	Packing
MD026	Powder Form-50g	36 bottles/carton
MD027	Powder Form-200g	24 bottles/carton
MD028	Powder Form-400g	12 bottles/carton

SUPER BATTLE BACTERIA 8000

- Highest concentration of stable purified liquid bacterial spores and excellent extra cellular enzym production. Faster effect and more effective
- Using innovative technology preserving live bacteria in liquid form. Bacteria will be activated only after releasing into the water. Those live bacteria are in their hibernating stage during the storage period. Do not need any special storage environment. Just place them under cool area will do. It is that simple and convenient
- Special "Denitrification" by Ocean Free Super Battle Bacteria (Convert the toxic ammonia to nitrite, nitrite to nitrate, nitrate to nitrogen gas). Break down large complex organic compounds quickly and effectively (Sludge)
- Control odors while reducing the C.O.D. and B.O.D.
- Not only Aerobic & Anaerobic but also facultative growth capabilities
- Extended Shelf Live, guarantee high bacterial counts (Over 6.8 billion cell count per ml of liquid)
- Solve green water and aglae problem and help to prevent fish disease
- More effective and speedy regenerating to aquatic plants / under gravel filter gravels
- Effective PH range: 5.0 - 9.5.
- Effective temperature range: 5°C - 50°C (40°F -120°F).
- For new & old tank / pond. Fast establishment
- Non pathogenic, environmentally safe



Code No.	Specification	Packing
WC073	Liquid-50ml	48 bottles/carton
WC074	Liquid-120ml	48 bottles/carton
WC075	Liquid-250ml	36 bottles/carton
WC076	Liquid-1000ml	10 bottles/carton

SUPER BATTLE BACTERIA 10000

- Highest concentration of stable purified bacterial spores and excellent extra cellular enzym production
- Special "Denitrification" by Ocean Free Super Battle Bacteria. (Convert the toxic ammonia to nitrite, nitrite to nitrate, nitrate to nitrogen gas)
- Extended Shelf Live, guarantee high bacterial counts (Over 52 billion cell count per gram of powder)
- More effective and speedy regenerating to aquatic plants / under gravel filter gravels
- Break down large complex organic compounds quickly and effectively. (Sludge)
- Not only Aerobic & Anaerobic but also facultative growth capabilities
- Solve green water and aglae problem and help to prevent fish disease
- Control odors while reducing the C.O.D. and B.O.D.
- For new & old tank / pond. Fast establishment
- Non pathogenic, environmentally safe



Code No.	Specification	Packing
WC077	Powder Form-10g	48 bottles/carton
WC078	Powder Form-20g	36 bottles/carton

'O' ANCHOR WORM & FISH LICE

Treat all external parasitical diseases (Anchor Worm and Fish Lice) problems for Arowanas, Stingrays and all rare / exotic sensitive fishes. Solely owned secret formula.

- Treat all Anchor Worm and Fish Lice attacks on Arowanas and Stingrays
- Effective even to kill the eggs and lava of parasites
- Can be use to treat crustaceans e.g. Trichodina and Gill Flakes
- Mild and safe and suitable to be use with sensitive wild caught fishes
- Not only for treatment purposes, also for prevention purposes
- Totally harmless to filter beneficial bacteria



Anchor Worm



Fish Lice



MD184 MD196

Code No.	Specification	Packing
MD184	Liquid-125ml	48 bottles/carton
MD196	Liquid-500ml	12 bottles/carton

'O' AROWANA DISEASE

For the prevention / curing of the following:

- Bacteria infection: Rotting of tail, body, fin, head, popping eyes, ulcer, dropsy, infection of wound etc
- Parasite infection: White spots, cloudy eyes, body slime, small sized external parasite (hexamita, trichodina, nematodes etc) and gill flakes etc
- Fungus infection: Cotton wool disease of tail, body, fins, head, fungi infection
- Gill disease infection: Rotting gills, sleeping disease, abnormal movement of gills and all other gill related diseases
- Kills bacteria and improve water quality
- Stop cross infection of new entrant fishes in existing tank / pond

* Specially formulated for Arowana / Stingray and other medium to big sized fishes



MD195 MD321

Code No.	Specification	Packing
MD195	Liquid-125ml	48 bottles/carton
MD321	Liquid-500ml	12 bottles/carton

'O' DISEASE

- Essence extracted from Herbal plants
- The ultimate cure for fish diseases
- Essential live-saving medication for your fishes

- Bacteria Infection: Rotting of tail, body, fin, head, popping eyes, ulcer, dropsy, infection of wound etc
- Parasite Infection: White spot, cloudy eyes, body slime, small sized external parasite (hexamita, trichodina, nematodes etc) and gill flakes etc
- Fungus Infection: Cotton wool disease of tail, body, fins, head, fungus on eggs / fries, fungi infection
- Gill Disease Infection: Rotting gills, sleeping disease, abnormal movement of gills and all other gill related diseases
- Unknown diseases: Fish blackening disease
- Planted tank: Safe and effective with good results
- Can be used to prevent all above mentioned diseases
- Kills bacteria and improve water quality
- Stop cross infection of new entrant fishes in existing tank / pond



MD185 MD186

Code No.	Specification	Packing
MD185	Liquid-50ml	48 bottles/carton
MD186	Liquid-125ml	48 bottles/carton

FISH STABILIZER

Ocean Free "Fish Stabilizer" is a newly developed fish anesthetic medication using German formulation. It is used for fish anesthetic to carry out minor operation / surgery. This medication can be used for fish transportation purposes as well. Making the fish fall into semi-conscious state therefore reducing oxygen consumption and prevent any violent movement / jumps. This will reduce chances of mortality during the transportation process.



MD020 MD021

Code No.	Specification	Packing
MD020	Liquid-100ml	70 bottles/carton
MD021	Liquid-1gallon	4 bottles/carton

FISH GUARD

- Fresh & Saltwater Conditioner
- Chlorine & Chloramine Remover
- Replenishes Protective Slime Shield
- Promotes Natural Healing with Aloe Vera and Vitamin E



WC012 WC013

Code No.	Specification	Packing
WC012	Liquid-500ml	21 bottles/carton
WC013	Liquid-1gallon	4 bottles/carton

ANTI-CHLORINE / GENERAL AID / WHITE SPOT / GILL, FUNGUS, PARASITE'S SPECIAL

- General usage for removing chlorine, treatment of fungus / bacteria and white spot disease
- High safety density, easy to use and effective



Code No.	Description	Specification	Packing
MD002	Anti-Chlorine Special	Liquid-240ml	12 bottles/carton
MD003	Anti-Chlorine Special	Liquid-500ml	12 bottles/carton
MD159	Anti-Chlorine Special	Liquid-1litre	6 bottles/carton
MD004	Anti-Chlorine Special	Liquid-1gallon	4 bottles/carton
MD006	General Aid Special	Liquid-240ml	12 bottles/carton
MD008	General Aid Special	Liquid-1gallon	4 bottles/carton
MD010	White Spot Special	Liquid-240ml	12 bottles/carton
MD012	White Spot Special	Liquid-1gallon	4 bottles/carton
MD014	Gill, Fungus, Parasite's Special	Liquid-240ml	12 bottles/carton
MD016	Gill, Fungus, Parasite's Special	Liquid-1gallon	4 bottles/carton
MD530	Advance Vitamin Complex	Liquid-240ml	12 bottles/carton

SUPER KOI

Guard-1

- Speedily neutralize Chloramine (most recent additive in tap water to kill harmful bacteria)
- For fast removing of chlorine and chloramines too
- Remove heavy metals and toxic chemicals
- Protection of fish gills and reduction of fish environmental stress
- A must have product for water changes

Anti-Parasite & fungus-2

- Made specifically for treatment of KOI "Sleeping Disease"
- For the treatment of White Spot, Cloudy Eyes, Body Slime and Velvet Disease
- Cotton wool disease and fungus can be treated as well

Anti-Ulcer, Internal / External Bactericide-3

- Specifically for the treatment of KOI Ulcer (body rot, tail rot, fin rot, gill rot)
- For the treatment of Dropsy, Popping Eyes and abnormal body discoloration as well
- Blood streaks and external bacteria infection



WC130

WC126

WC127

WC125

MD203

MD205

MD206

MD204

1 litre Packaging

Code No.

Description

Specification

Packing

WC125
WC126
WC127
WC130

Super Koi Guard-1
Super Koi Guard-1
Super Koi Guard-1
Super Koi Guard-1

Liquid-250ml
Liquid-1litre
Liquid-2litre
Liquid-1gallon

36 bottles/carton
10 bottles/carton
8 bottles/carton
4 bottles/carton

MD203
MD204

Anti Parasite & Fungus-2
Anti Parasite & Fungus-2

Liquid-250ml
Liquid-1litre

36 bottles/carton
10 bottles/carton

MD205
MD206

Anti-Ulcer, Internal / External Bactericide-3
Anti-Ulcer, Internal / External Bactericide-3

Liquid-250ml
Liquid-1litre

36 bottles/carton
10 bottles/carton

NEW WATER GUARD

- Immediate eradicate or neutralize Chloramine (most recent additive in tap water to kill harmful bacteria)
- Remove chlorine and chloramines as well
- Assist in removing heavy metals and toxic chemicals
- Protection of fish gills and reduction of fish stress
- Provide pristine water quality for aquariums



WC118

Code No.

Specification

Packing

WC116
WC117
WC118
WC119

Liquid-120ml
Liquid-250ml
Liquid-1litre
Liquid-2litre

48 bottles/carton
36 bottles/carton
10 bottles/carton
8 bottles/carton

WC117

WC116

WC119

AQUA FRESH COAT

- Replaces the natural slime coating which fish may lose in times of stress
- Contains aloe vera to promote the healing of skin wounds and torn fins
- Removes chlorine from tap water

Code No.	Specification	Packing
WC008	Liquid-100ml	70 bottles/carton
WC006	Liquid-250ml	36 bottles/carton
WC009	Liquid-500ml	21 bottles/carton
WC007	Liquid-1litre	10 bottles/carton
WC011	Liquid-2litre	8 bottles/carton
WC010	Liquid-1gallon	4 bottles/carton



NATURAL AQUATIC GUARD

- Remove Toxic and Heavy Metals
- Reduce stress of fishes after each water change or newly added fishes
- Assisting in fish's natural secretion of their natural protective coating
- Enhance tap water quality by removing chlorine & chloramines instantly

Code No.	Specification	Packing
WC121	Liquid-250ml	36 bottles/carton
WC122	Liquid-500ml	21 bottles/carton
WC123	Liquid-1litre	10 bottles/carton
WC124	Liquid-2litre	8 bottles/carton



ANTI-CHLORINE CRYSTAL

The latest improved German formula water conditioner use to improve the aquarium water quality by removing the chlorine and all the harmful gases from the water. It is Economic, Colourless, Safe and Non-Toxic to aquarium fishes and plants ever when excessively used.

Code No.	Specification	Packing
WC120	1kg	12 packets/carton



WC120

MAGNA SALT & MAGNA EPSOM SALT

- Treats mild dropsy, abdominal bloat, exothalmus (swelling of the eyes) and constipation and body imbalance
- Helps to maintain osmotic balance in fishes
- Stress reliever for all fishes

MAGNA SALT & MAGNA EPSOM SALT (New Improved Formulation of Aquarium Salt) is a muscle relaxant that helps to relief the stress caused by osmotic imbalance in fishes. Osmotic balance is important in fishes as it is often the root cause of many diseases such as stomach bloat, mild dropsy and many other chronic diseases.



Code No.	Description	Specification	Packing
MD354	Magna Salt	600g	24 boxes/carton
MD355	Magna Salt	1200g	12 boxes/carton
MD356	Magna Salt	2400g	6 boxes/carton
MD510	Magna Epsom Salt	600g	24 boxes/carton
MD511	Magna Epsom Salt	1200g	12 boxes/carton
MD512	Magna Epsom Salt	2400g	6 boxes/carton

STRESS RELIEVER SALT

- Professional grade Aquarium Salt for Freshwater Aquaria
- Non-artificial processing – Purely made from evaporated Sea Water through saturated cry stallization and high-speed evaporation process
- Helps to reduce stress and enhance acclimatization
- Adds electrolytes and helps gill function of fishes
- Accelerate and advance disease healing

Code No.	Specification	Packing
MD150	500g	24 boxes/carton
MD151	1000g	12 boxes/carton
MD152	2000g	6 boxes/carton



SPECIAL TREATED AQUARIUM SALT

- Specially recommended for all tropical fishes (especially Discus, Koi, Goldfish, Arowana, etc.)
- As a disease preventive (e.g. Ich, Fungus, Parasites)
- Disinfects the tank water
- An effective Dip Treatment for many disease causing organisms
- Ideal for quarantine of new fish with medication
- Suitable for hatching Brine Shrimp eggs

Code No.	Specification	Packing
MD032	500g	10 packets/carton



ECONOMY SALT

- Common economic aquarium salt for general aquatic use
- Clean and easy direct use

Code No.	Specification	Packing
MD149	1kg	12 packets/carton





PP296 5cm x 8cm
Plastic Plant
25 pieces/carton



PP297 5cm x 8cm
Plastic Plant
25 pieces/carton



PP298 5cm x 8cm
Plastic Plant
25 pieces/carton



PP299 5cm x 8cm
Plastic Plant
25 pieces/carton



PP300 6cm x 10cm
Plastic Plant
25 pieces/carton



PP301 6cm x 10cm
Plastic Plant
25 pieces/carton



PP302 6cm x 10cm
Plastic Plant
25 pieces/carton



PP303 6cm x 10cm
Plastic Plant
25 pieces/carton



PP304 9cm x 18cm
Plastic Plant
25 pieces/carton



PP305 9cm x 18cm
Plastic Plant
100 pieces/carton



PP306 9cm x 18cm
Plastic Plant
25 pieces/carton



PP307 9cm x 18cm
Plastic Plant
25 pieces/carton



PP308 15cm x 26cm
Plastic Plant
25 pieces/carton



PP309 15cm x 26cm
Plastic Plant
25 pieces/carton



PP310 15cm x 26cm
Plastic Plant
25 pieces/carton



PP311 15cm x 26cm
Plastic Plant
25 pieces/carton



PP312 20cm x 36cm
Plastic Plant
25 pieces/carton



PP313 20cm x 36cm
Plastic Plant
25 pieces/carton



PP314 20cm x 36cm
Plastic Plant
25 pieces/carton



PP315 30cm x 50cm
Plastic Plant
25 pieces/carton



PP316 30cm x 50cm
Plastic Plant
25 pieces/carton



PP317 30cm x 50cm
Plastic Plant
25 pieces/carton



PP318 9cm x 18cm
Plastic Plant
25 pieces/carton



PP319 9cm x 18cm
Plastic Plant
25 pieces/carton



PP320 9cm x 18cm
Plastic Plant
25 pieces/carton



PP321 15cm x 26cm
Plastic Plant
25 pieces/carton



PP322 15cm x 26cm
Plastic Plant
25 pieces/carton



PP323 20cm x 36cm
Plastic Plant
25 pieces/carton



PP324 30cm x 50cm
Plastic Plant
25 pieces/carton

- High quality self-sinking plastic plants
- Realistically made and assist in creating natural environment in tanks

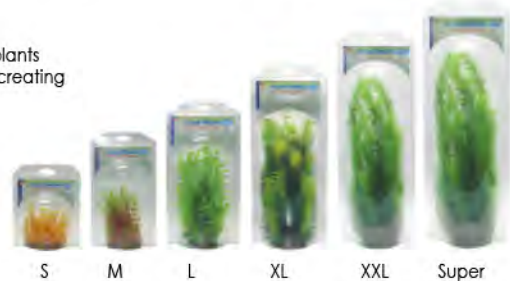

PIPE HIDEOUT

Mix and Match ; available in 7 different shapes and sizes!

Features

- Perfect hiding place for small fishes, invertebrate and small hamsters
- Easy to fit together to form your ideal design
- Non-toxic and safe for livestock
- Strong and sturdy structure



AA237
Straight



AA238
Elbow



AA239
T-Joint



AA240
Cross-Joint



AA241
Short



AA242
Medium



AA243
Long

Connectors Pipes Note: Must be connected to a Straight Pipe; they cannot be fitted to another Connector Pipe.

Code No.	Model	Specification
AA237	Straight	L120mm x Ø63mm. No access holes.
AA238	Elbow	L95mm x W95mm x Ø63mm. 1 x Ø30mm access holes.
AA239	T-Joint	L120mm x W95mm x Ø63mm. No access holes.
AA240	Cross-Joint	L125mm x 120mm x Ø63mm. No access holes.

Packing

24 pieces/carton
24 pieces/carton
24 pieces/carton
24 pieces/carton

Straight Pipes Note: Must be connected via a Connector Pipe; they cannot be fitted to another Straight Pipe.

Code No.	Model	Specification
AA241	Short	L415mm x Ø55mm. 3 x Ø30mm access holes.
AA242	Medium	L115mm x Ø55mm. 1 x Ø30mm access holes.
AA243	Long	L45mm x x Ø55mm. No access holes.

Packing

24 pieces/carton
24 pieces/carton
12 pieces/carton

RESINS ORNAMENTS

- Colorful high quality resins for aquarium and other pet use
- Non toxic and detailed workmanship
- Comes in various design and patterns
- Customization possible upon request



Code No.	Description	Specification	Packing
ACL	Anchor	Superior Resin	36 pieces/carton
BKL	Drum (L)	Superior Resin	36 pieces/carton
BKM	Drum (M)	Superior Resin	48 pieces/carton
WSML	Wreck Ship (M) Left	Superior Resin	36 pieces/carton
WSMR	Wreck Ship (M) Right	Superior Resin	36 pieces/carton
Y17	Shoe	Superior Resin	24 pieces/carton
Y18	Small Jar	Superior Resin	120 pieces/carton
Y19	Medium Jar	Superior Resin	60 pieces/carton
Y20	Big Jar	Superior Resin	12 pieces/carton
Y139	Wooden Bridge (16 x 2 x 6cm)	Superior Resin	48 pieces/carton
Y140	Wooden Bridge (22 x 3 x 8cm)	Superior Resin	24 pieces/carton
Y141	Wooden Bridge (34.7 x 14.3 x 7.7cm)	Superior Resin	18 pieces/carton

BUBBLE RING LED LIGHT

Now's the time to give air stone a second look

- Energy saving, safe and non-toxic
- Multi-color illumination modes
- Innovative decoration
- Dynamic bubble + light display
- Safety low-voltage design
- Multi usage



Code No.	Descriptit	Specification	Packing
AL403	Bubble Ring LED Light	0.72W (0.12Wx6)	36 pieces/carton
AL404	Bubble Ring LED Light	1.08W (0.12Wx9)	36 pieces/carton
AL405	Bubble Ring LED Light	1.44W (0.12Wx12)	24 pieces/carton

BUBBLE CURTAIN LED LIGHT

Underwater Led With Multiple Light Modes

- Energy saving, safe and non-toxic
- Dynamic bubble + Light display
- Multiple display modes
- 7 Light colours / mode
- Multi usage

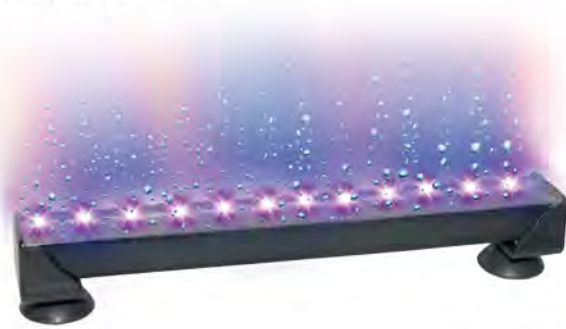

AL398
AL399
AL400
AL401
AL402

Code No.	Description	Specification	Packing
AL398	Bubble Curtain LED Light	15cm - 1.44W (0.24W x 6)	24 pieces/carton
AL399	Bubble Curtain LED Light	20cm - 2.16W (0.24W x 9)	24 pieces/carton
AL400	Bubble Curtain LED Light	30cm - 3.60W (0.24W x 15)	12 pieces/carton
AL401	Bubble Curtain LED Light	45cm - 5.04W (0.24W x 21)	12 pieces/carton
AL402	Bubble Curtain LED Light	60cm - 7.20W (0.24W x 30)	12 pieces/carton

EVER CHANGING LED MULTI-COLOUR LIGHT

- Low Voltage (12v)
- Safe and user friendly
- 7 fun & attractive colour
- Multi usage
- Multi mode display: Steady blinking Steady on Sequential changing Rotating blinking



RoHS CE



Suggested Application:

Accentuate aquatic ornaments

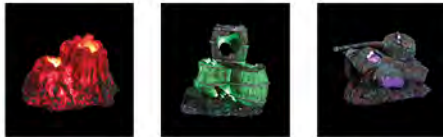

Add life & colour to aquatic or plastic plants



Create vibrant bubble light-show



Spice up dull aquarium backgrounds



Code No.	Description	Specification	Packing
AL288	Ever Changing LED Multi-Colour Light	Water Proof	36 pieces/carton

DRIFTWOOD (BLISTER)

- Exotic driftwood for aquarium / terrarium use
- Clean and readily sinks in water
- Assist in water softening effect
- Provide the most natural decor for tanks

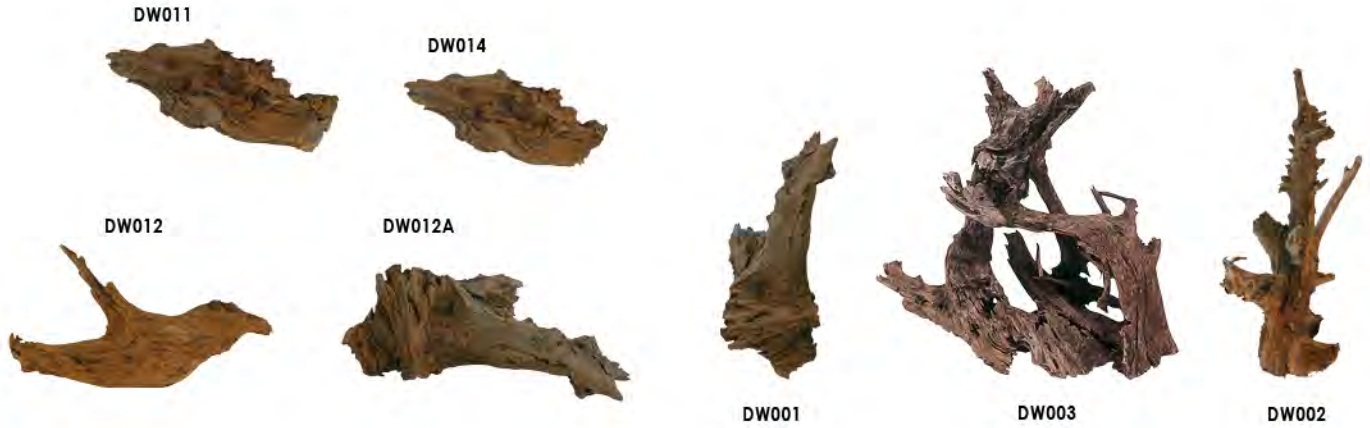

Code No.	Specification	Packing
DW014	SS (3 pieces pack)	60 packets/carton
DW011	S	60 pieces/carton
DW012	M	25 pieces/carton
DW012A	M-L	15 pieces/carton
DW001	L	upon request
DW002	XL	upon request
DW003	XXL	upon request

TWITY WOOD (SEASONAL)

- Exotic driftwood for aquarium / terrarium use
- Clean and readily sinks in water
- Assist in water softening effect
- Provide the most natural decor for tanks



Code No.	Specification	Packing
DW017	By Weight	upon request

3DM

NATURAL SEAWATER MINERALS SAND



1 - 2mm



3 - 4mm



* for display only.

FEATURES

- 1) Derived from pollution-free resource and processed using 3DM technology to ensure that there are no parasite worms, microorganisms or parasitic materials. It is absolutely free of viruses and harmful bacteria.
- 2) Its pure white color makes the seawater aquarium look more beautiful. The clean white and three-dimensional look, effectively improves the efficiency of the photogenic source by more than 30%.
- 3) It contains natural calcium required by seawater organisms, and also naturally occurring important magnesium, which provides more comprehensive elements for seawater organisms, which ordinary coral sand cannot provide.
- 4) Not mined from the natural sea, it protects the environment and does not destroy our natural environment.
- 5) The quality is guaranteed, the supply is stable, and there will be no shortage of supply.
- 6) It sediments down quickly (1-3 hours) and the water clarifies faster, especially when setting up a new tank.
- 7) pH-7.8 - 8.2

PREPARATIONS

Rinse the 3DM Natural seawater minerals sand with some clean water to wash away the fine particle dust on the surface, so that the water in the fish tank will be clear faster after the setup.

USAGE AMOUNT

Fill the tank base with sand leveled to at least 3-5 cm. For hobbyists with special requirements, the sand can be leveled to around 7.5cm.

Code No	Description	Specification	Packing
AG193	3DM Natural Seawater Minerals Sand 5KG	1-2mm	4 bags/carton
AG194	3DM Natural Seawater Minerals Sand 5KG	3-4mm	4 bags/carton

NATURAL PEBBLE

Special natural collected pebble

Code No.	Description	Specification	Packing
AG0238	Rainflower Stone	1kg	20 packets/carton
AG0241	Rainflower Stone	5kg	4 packets/carton



PREMIUM AQUATIC GRAVEL

For The Use Of Aquatic, Normal Landscaping and Other Purposes

- Neutral in pH value
- 100% Natural Gravel from streams / rivers
- Brings back the feel of nature
- Clean, attractive and brings vibrancy to your tank



Dark Col River Gravel



Light Col River Gravel



Black Crystal Sand



Code No.	Description	Specification	Packing
AG111	Black Crystal Sand	10kg	individual
AG0211	Dark Col River Gravel	1kg	20 packets/carton
AG0212	Dark Col River Gravel	5kg	4 packets/carton
AG0209	Dark Col River Gravel	10kg	individual
AG0210	Dark Col River Gravel	20kg	individual
AG0221	Light Col River Gravel	1kg	20 packets/carton
AG0222	Light Col River Gravel	5kg	4 packets/carton
AG0219	Light Col River Gravel	10kg	individual
AG0220	Light Col River Gravel	20kg	individual

COLOUR STONE

High Quality Colour Stone



White Black Colour Stone



White Jade Colour Stone



High Class Colour Sand



Neon Colour Stone (S)



Neon Colour Stone (ML)

Code No.	Description	Specification	Packing
AG0242	White Black Colour Stone	1kg	20 packets/carton
AG0244	White Black Colour Stone	5kg	4 packets/carton
AG0249	White Jade Colour Stone	1kg	20 packets/carton
AG0251	White Jade Colour Stone	5kg	4 packets/carton
AG0204	High Class Colour Sand	1kg	20 packets/carton
AG0205	High Class Colour Sand	5kg	4 packets/carton
AG0227	Neon Colour Stone (S)	1kg	20 packets/carton
AG0231	Neon Colour Stone (S)	5kg	4 packets/carton
AG0226	Neon Colour Stone (ML)	1kg	20 packets/carton
AG0230	Neon Colour Stone (ML)	5kg	4 packets/carton

NANO TECH BUBBLE DIFFUSER

Features

Helps create low turbulence, highly oxygenated aquarium environment.

- Creates aesthetically pleasing ultra-fine bubbles
- Helps increase DO (Dissolved Oxygen) level in Aquarium
- Nano Bubbles causes less water loss due to splashing compared to large bubbles
- Stays in water for prolonged periods of time



Does not require high pressure airpump. Usable with most conventional airpump.



Suggested Installation

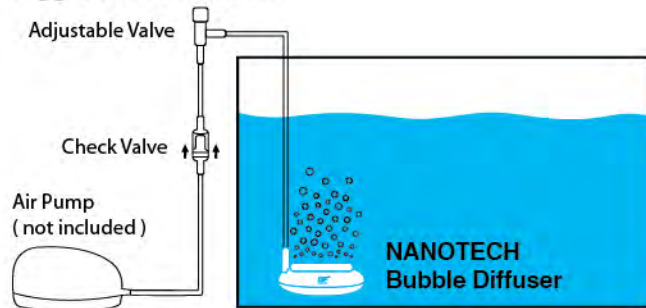

Includes

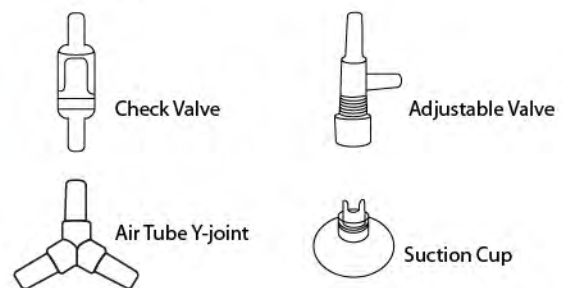

Code No.

AS090
AS091
AS092

Description

Nano Tech Bubble Diffuser 50mm disc
Nano Tech Bubble Diffuser 100mm disc
Nano Tech Bubble Diffuser 150mm disc

Specification

ø50mm / ø70mm
ø100mm / ø130mm
ø150mm / ø180mm

Packing

100 pieces/carton
30 pieces/carton
20 pieces/carton

BUBBLESTRIP AIRSTONE

- High quality airstone with fine bubble diffusion
- Long lasting and less clogging
- Available in different sizes



Code No.	Specification	Packing
A0234	4"	600 pieces/carton
A0236	6"	600 pieces/carton
A0238	8"	300 pieces/carton
A02310	10"	300 pieces/carton
A02312	12"	300 pieces/carton
A02316	16"	210 pieces/carton
A02318	18"	210 pieces/carton
A02320	20"	150 pieces/carton
A02324	24"	150 pieces/carton
A02328	28"	120 pieces/carton
A02332	32"	90 pieces/carton
A02342	42"	90 pieces/carton

A02316
A02318
A02320
A02324
A02328
A02332
A02342

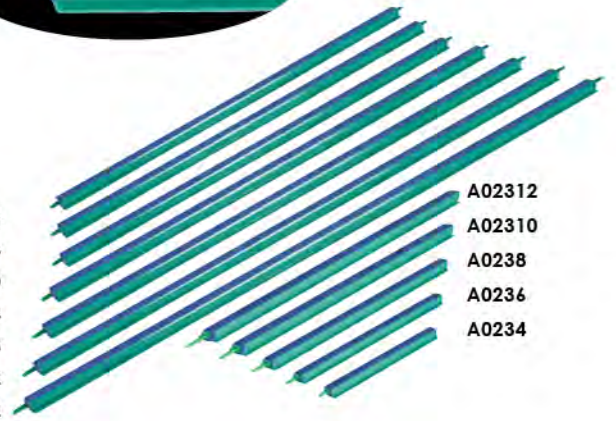

MIXED SHAPE AIRSTONE

- High quality airstone with fine bubble diffusion
- Long lasting and less clogging
- Available in different sizes

Code No.	Specification	Packing
A003	Cylinder-ø15 x 25mm	2880 pieces/carton
A008	Cylinder-ø18 x 50mm	1152 pieces/carton
A009	Cylinder-ø25 x 50mm	576 pieces/carton
A004	Round-ø20mm	2592 pieces/carton
A005	Round-ø25mm	1440 pieces/carton
A006	Round-ø30mm	864 pieces/carton
A007	Round-ø50mm	192 pieces/carton



BLUE CHECK VALVE

- High quality check valve for water back flow prevention
- Assist the prevention of back flow for air pumps etc
- Made with high quality materials, long lasting and corrosion free



Code No.	Specification	Packing
AA100	Special Plastic	100 pieces/bag

SPECIAL CERAMIC AIR STONE

- High quality special ceramic airstone made under high temperature heating to prevent clogging and produce the finest bubbling
- Weighted down to be used readily
- Comes in different shape and sizes

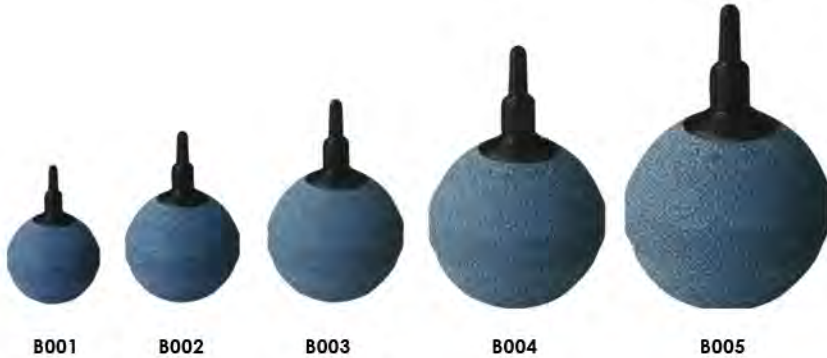

Code No.

B001	Round-ø20mm
B002	Round-ø25mm
B003	Round-ø32mm
B004	Round-ø40mm
B005	Round-ø50mm

Plastic End Cylinder

B011	ø15 x 70mm
B012	ø20 x 80mm
B014	ø30 x 80mm
B015	ø30 x 105mm

Packing

2592 pieces/carton
1440 pieces/carton
864 pieces/carton
288 pieces/carton
192 pieces/carton

960 pieces/carton
384 pieces/carton
144 pieces/carton
144 pieces/carton

LIMEWOOD AIRSTONE

- Natural micro pores in wood create incredibly fine bubbles
- Ideal for OF® Nano Skimmers, Air Driven Protein Skimmers and Foam Fractionators

Code No.

AS069

Packing

48 pieces/carton



CLASSIC SERIES AIR STONE

- Aerates aquarium
- Creates water movement
- Produces attractive bubbles
- Increases gas exchange at water surface

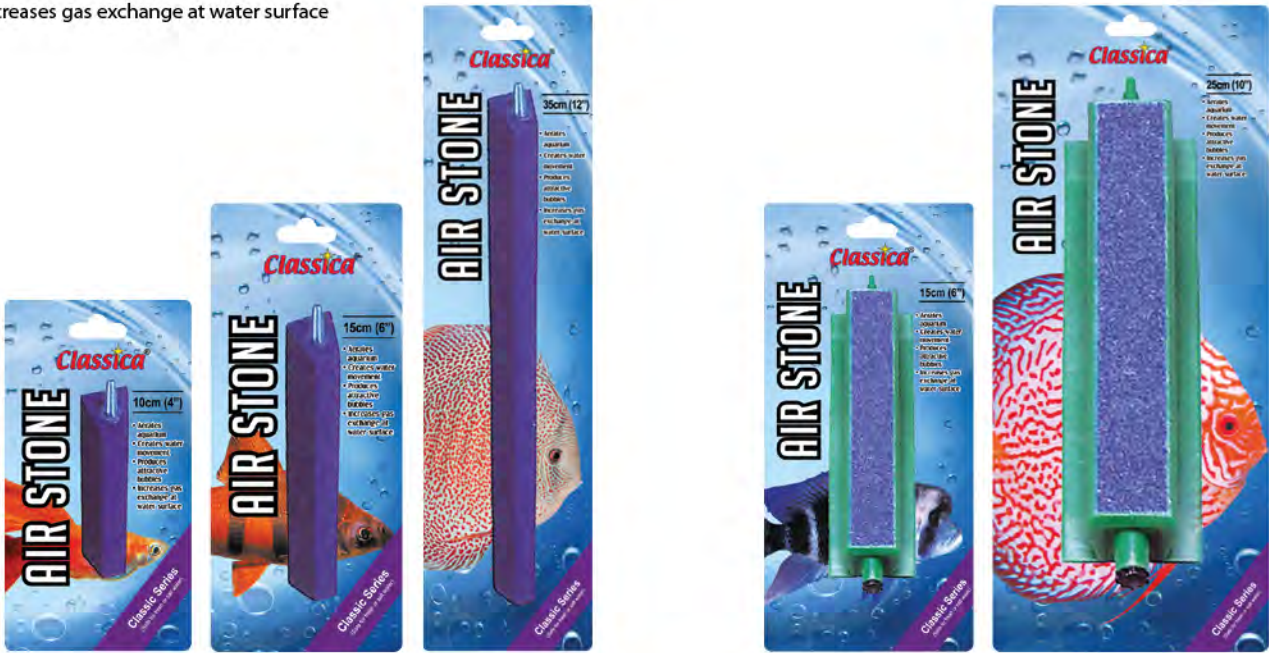

AS042

AS043

AS044

AS050

AS051



AS045

AS046

AS047

AS048

AS049

Code No.

Specification

Packing

AS042	Triangle-100mm (4")	360 pieces/carton
AS043	Triangle-150mm (6")	240 pieces/carton
AS044	Triangle-300mm (12")	144 pieces/carton
AS045	Cylindrical-ø15 x 25mm (2 pieces/pack)	864 pieces/carton
AS046	Cylindrical-ø15 x 25mm (4 pieces/pack)	432 pieces/carton
AS047	Round-ø50mm	144 pieces/carton
AS048	Round-ø20mm (2 pieces/pack)	864 pieces/carton
AS049	Cylindrical-ø25 x 50mm	432 pieces/carton
AS050	Bubble Strip-150mm (6")	240 pieces/carton
AS051	Bubble Strip-250mm (10")	144 pieces/carton

HI TEMPERATURE SERIES AIR STONE

- Aerates aquarium
- Creates water movement
- Produces attractive bubbles
- Increases gas exchange at water surface



AS055

AS056



AS057



AS058



AS059



AS060



AS063

AS062



AS061



AS064

AS065

Code No.

AS055
AS056
AS057
AS058
AS059
AS060
AS061
AS062
AS063
AS064
AS065

Specification

Round- \varnothing 50mm
Round- \varnothing 20mm (2 pieces/pack)
Disk- \varnothing 80 x 15mm
Disk- \varnothing 100 x 18mm
Disk- \varnothing 120 x 15mm
Disk- \varnothing 150 x 18mm
Plastic End Cylinder- \varnothing 30 x 130mm
Plastic End Cylinder- \varnothing 40 x 220mm
Plastic End Cylinder- \varnothing 50 x 300mm
Disk- \varnothing 107 x 19mm
Disk- \varnothing 132 x 19mm

Packing

144 pieces/carton
864 pieces/carton
80 pieces/carton
60 pieces/carton
45 pieces/carton
30 pieces/carton
120 pieces/carton
48 pieces/carton
24 pieces/carton
60 pieces/carton
40 pieces/carton

HEAD BRASS, WAY GANG & DISTRIBUTOR

- Made with high quality non-corrosive material
- For precise air flow regulating
- Made for long lasting use

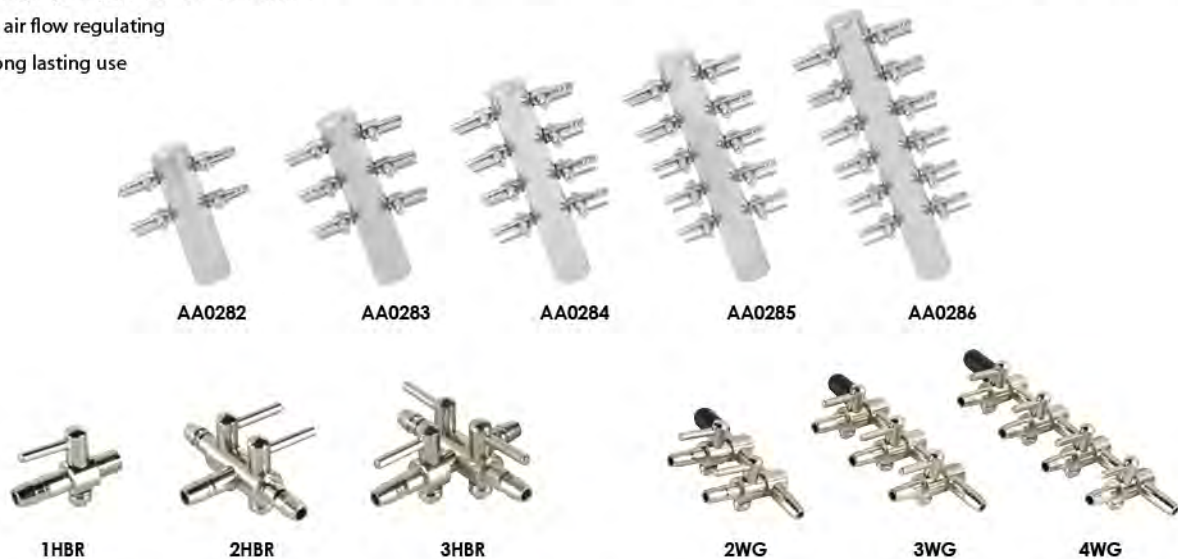

Code No.	Description	Specification	Packing
1HBR	Head Brass (8105)	1 head	3000 pieces/carton
2HBR	Head Brass (8101)	2 head	2000 pieces/carton
3HBR	Head Brass (8102)	3 head	1200 pieces/carton
2WG	Way Gang	2 way	576 pieces/carton
3WG	Way Gang (8102)	3 way	576 pieces/carton
4WG	Way Gang (8103)	4 way	384 pieces/carton
AA0282	Distributor	4 way	48 pieces/carton
AA0283	Distributor	6 way	48 pieces/carton
AA0284	Distributor	8 way	48 pieces/carton
AA0285	Distributor	10 way	48 pieces/carton
AA0286	Distributor	12 way	48 pieces/carton

AQUARIUM SILICONE TUBE / NORMAL TUBING

- High quality silicone tubing
- Available in different colors
- Long lasting and will not harden / brittle after long use and do not cause extreme bending



* Normal PVC tubing for more general use. (For noormal tubing)

Code No.	Description	Specification	Packing
AA244	Normal Tubing	50m	10 rolls/carton
AA0292	Hi-Soft White Tubing	100m	8 rolls/carton
AA0293	Hi-Soft Black Tubing	100m	8 rolls/carton
AA0294	Hi-Soft Blue Tubing	100m	8 rolls/carton
AA0295	Hi-Soft Green Tubing	100m	8 rolls/carton

3DM Gramaran Rock



* for display only.



FEATURES

3DM Gramaran Rock strictly selects natural minerals as the main anchoring raw material. A combination of environmental-friendly, energy-saving and carbon reduction technologies. Using industrial intelligent processing system and multi-pole 3D composite mold forming techniques, to create natural, multi-layered rough porous surfaces and three-dimensional natural cavity structures. High temperature molten liquid gas foaming and sintering process, capable of creating high degree two-dimensional and three-dimensional pores.

SPECIAL FEATURES

1. High temperature sintering effect
2. High water absorption rate (more than 20%)
3. High water retention characteristics
4. Specific Gravity: Less than 1.5
5. Completely unique and natural shape
6. Suitable for use in general aquarium tank, planted tank, terrarium tank, gardening and indoor landscaping
7. Functional biological medium



* size can be customized



Small



Medium



Large

Code No	Description	Specification	Packing
FM208	3DM Gamaran Rock S	<0.5kg	36 pcs/carton
FM209	3DM Gamaran Rock M	<0.7 - 1.7kg	16 pcs/carton
FM210	3DM Gamaran Rock L	<1.5 - 2.5kg	8 pcs/carton

3DM PH+ BEADS

As time goes by when fishes are raised in a pond, acidification of the pond water will usually occur, and it will cause some organ dysfunction of the fish, ranging from fish body diseases and decline in the fish immune system, and can even severely cause fish mortalities. 3DM PH⁺ Beads are specially developed for solving the above water acidification problems. After many incremental improvement trials, the effectiveness has been doubled. The small round sphere design also greatly increases the contact area between PH⁺ beads and water, which makes the effect better and faster. The main ingredients are all natural materials, which are safe, effective and environmentally friendly.



Free of all Parasites, Pathogens and Viruses.

Many fish hobbyists like to add coral sand, clam shells, "live rocks" and other similar products to the fish pond to increase the water pH value, because these stuffs are rich in calcium carbonate, which can achieve the effect of increasing the water pH value. But these products will have a great counter-effect if they are not handled well. Coral sand, "live rocks" and clam shellfish will co-exist with parasites, microorganisms, bacteria and other viruses. No matter how you disinfect and sterilize them, pathogens can never be 100% removed, because they are the first choice host body of pathogens. Putting them directly into the fish tank or fish pond is like adding parasites and pathogens directly to the fish pond, which will cause major harm to the health of the fish and their immune system. 3DM PH⁺ beads are sintered and sterilized at high temperature, which can minimize the above-mentioned problems, and is safe, convenient and reliable.

High Performance, Low Shock

Long-term observation and repeated experiments in the laboratory shows that 1kg of 3DM PH⁺ beads can increase the pH of 1000L of water by about 0.5-1.5 after 1-3 days of application. The increase in pH value varies according to different water quality. The lower the initial pH value, the more will be the increase in pH value. When the initial pH value is higher, the increase in pH value is lesser, and the effect of this feature is very significant. 3DM PH⁺ beads are quite different from commercially available chemical conditioners. Chemicals conditioners will increase the pH value in a short period of time, causing the pH value to fluctuate erratically which may cause the fish to be unable to withstand the shock and die. On the contrary, 3DM PH⁺ beads steadily increases the pH value to reduce the effect of pH shock, so that the water quality reaches optimum stability.

Stabilizing pH value

Fish ponds will continuously produce acid due to biodegradation. These acids will gradually deplete the buffering substances in the water that are already in shortage in the water. Therefore, the buffering effect will slowly disappear, resulting in a significant drop in the pH value. 3DM PH⁺ beads can increase the pH value, while at the same time also release bicarbonate and increases the KH value as well, which can effectively increase the fish pond's buffering capability towards acidic substances produced by biodegradation, thereby achieving a stable pH value. It's one product with multiple functions.

Environmental Friendly, Environmental Enhancement, Recyclable

3DM PH⁺ beads are made of natural minerals and are harmless to the environment. When the performance of 3DM PH⁺ beads becomes lowered gradually, they do not need to be taken out and discarded. 3DM PH⁺ beads are porous materials, which can become a biological filter media after its exhaustion, which is a great media for cultivation of nitrifying bacteria and probiotics. Thus, achieving the effect of sustainable resource and recycling. Care for your beloved fish, be a responsible environmentalist by using this product, because it is environmentally friendly.

Instructions :

Freshwater Application

- * It is recommended to add 1 kg of 3DM PH⁺ beads to 1000L of water. The pH value can be measured after 3-7 days. If the pH value is not attained to minimize pH shock, please add 1kg of 3DM PH⁺ beads to 2000L of water. Repeat the above steps until you get the ideal pH value you want.
- * The amount to be applied in each pond will vary, depending on the source of the raw water, the amount of feeding, the stocking density of the fishes, the filtration system type...etc., and will affect the amount needed.
- * It is recommended to add it after the filtration biological system and where the water flow is relatively smooth, so that the pH value will be more balanced.

Seawater Application

- * It is recommended to add 300 grams of 3DM PH⁺ beads per 100L of seawater. The pH value can be measured after 3 days. If the required pH value is not reached, please repeat the above dosage until the required pH value is attained.
- * It is recommended to place it in a position where the water flow is smooth, so that the pH value will be more balanced.

Code No	Description	Specification	Size	Packing
FM207	3DM PH+ Beads	500g / 0.4L	7-9mm	24 bags/carton

3DM PH⁺

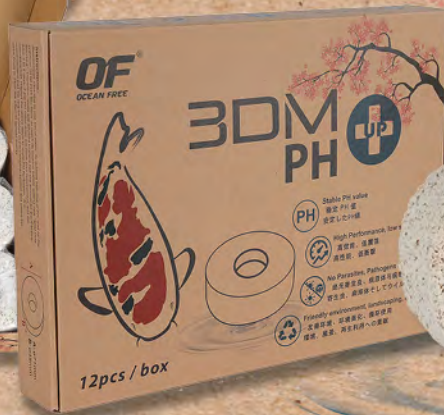

Stable PH value



High Performance,
low shock



No Parasites,
Pathogens and viruses



Friendly environment,
landscaping, recycling

"3DM PH⁺ Bio-Ring" helps to eliminate acidosis that might cause malfunction of fish organ leading to slow growth rate, decrease in egg production, reduces of PH in blood while concentration level of H⁺ ions is increase. As it is made of natural minerals, no chemical is added thus providing a better and safe environment for fish to grow.

No Parasites, Pathogens and viruses.

"3DM PH⁺ Bio-Ring" is sintered and processed at a high temperature which is free from parasites, microorganisms, bacteria and other fungi thus making it is safe, convenient and reliable.

High Performance, low shock

"3DM PH⁺ Bio-Ring" can increase PH value of 0.5 to 1.5 in 1 ton of water after 1 to 3 days use. Unlike other pharmaceuticals and chemical available in the market which increases the PH in a short period of time, causing the PH to swing and PH shock which sometimes might cause death in fishes.

Stable PH value

"3DM PH⁺ Bio-Ring" is able to increase the PH value while releasing the bicarbonate and raises the KH value at the same time to achieve a stable PH and act as a buffer, a product of multiple usage.

Friendly environment, landscaping, recycling.

"3DM PH⁺ Bio-Ring" is a natural mineral composition that is harmless to the environment. As "3DM PH⁺ Bio-Ring" is a porous material, it can be used as a filter medium to cultivate nitrifying beneficial bacteria after the function has wear off promoting a responsible act for the environment.

Code No.
FM199

Description
3DM PH UP

Specification
ø71 x 45mm

Packing
12 pieces/carton
6 boxes (72 pieces) / carton



A: ø71mm
B: 45mm



3DM BACTO-ROCK

Beautifies and Enhances Water Quality !



Does not affect pH | 1000m² / litre Effective Surface Area

OF® 3DM Bacto-Rock is a filtration-medium shaped to resemble a natural rock, allowing you to create a beautiful natural environment for your fishes while keeping your water clean! This macro-porous and tough 'rock' greatly boosts the beneficial bacteria population and increases the rate at which harmful toxins like Ammonia and Nitrite are broken down.

Crafted entirely using advanced manufacturing technology, it is a sterilized, pH-neutral rock that does not contain any impurities, algae or pest making it 100% safe and 100% ready to use.

What are the advantages of OF® 3DM BACTO-ROCK?

- **Macro-Porous structure for Beneficial Bacteria.** Advanced manufacturing and high temperature processes has given OF® 3DM Bacto-Rocks their distinctive lightweight, tough and porous structure. Within the tough exterior lies cavities all interlinked by micro-tunnels.
- **Reduces Ammonia and Nitrite.** The cavities and interlinked micro-tunnels increase the overall effective BET surface area (1000m² / litre); creating ideal conditions for billions of Beneficial Bacteria that helps break down harmful toxins like Ammonia and Nitrite.
- **No cleaning required.** 100% sterile, free of impurities, algae and pests making it 100% safe and 100% ready to use.
- **pH Neutral.** Does not affect pH levels.
- **Environmentally green product.** An environmentally friendly alternative which replaces the need to harvest rocks from nature.
- **Easy to form your dream scape.** 3DM Bacto-Rock is easy to stack, interlock or decorate to form the natural looking rock scapethat you've always wanted!



3DM Bacto-Rock



3DM Bacto-Plate

Code No.

FM189
FM190
FM191
FM192
FM193
FM198

Description

OF 3DM Bacto-Rock (S)
OF 3DM Bacto-Rock (M)
OF 3DM Bacto-Rock (L)
OF 3DM Bacto-Plate (S)
OF 3DM Bacto-Plate (M)
OF 3DM Bacto-Plate (L)

Specification

(<1.5kg)
(<1.5kg-2.5kg)
(<2.5kg-3.5kg)

Packing

9-12 kg/carton
9-12 kg/carton
9-12 kg/carton
9-12 kg/carton
9-12 kg/carton
9-12 kg/carton



3DM BACTO-SAND

Beautifies and Enhances Water Quality !



1kg



5kg



OF® 3DM Bacto-Sand is a revolutionary man-made "sand" that functions as a beneficial bacteria sand-bed, allowing you to create a beautiful natural environment for your fishes while keeping your water clean! The macro-porous structure greatly boosts the beneficial bacteria population and increases the rate at which harmful toxins like Ammonia and Nitrite are broken down.

Crafted entirely using advanced manufacturing technology, Bacto-Sand's rounded surface encourages water flow which prevents the build-up of harmful toxins in the sand-bed. Its rounded surface also makes it safe for the barbels of bottom-feeders like Corydoras, loaches, etc. This sterilized and pH-neutral sand does not contain any impurities, making it 100% safe and 100% ready to use.

What are the advantages of OF® 3DM BACTO-SAND?

- **Reduces Ammonia and Nitrite.** OF® 3DM Bacto-Sand's high overall effective BET surface area (1000m² / litre) helps create a beneficial bacteria sand-bed that provides ideal conditions for billions of Beneficial Bacteria that helps break down harmful toxins like Ammonia and Nitrite.
- **Minimizes Dead Spots.** OF® 3DM Bacto-Sand's rounded surface encourages water flow in the sand-bed, greatly minimizing dead spots and the subsequent build-up of harmful toxins.
- **Bottom-Feeder Friendly.** The rounded surface makes it safe for the barbels of bottom-feeders like Corydoras, loaches, etc.
- **No cleaning required.** 100% sterilized and free of impurities making it 100% safe and 100% ready to use.
- **pH Neutral.** Does not affect pH levels.
- **Environmentally green product.** An environmentally friendly alternative which replaces the need to harvest sand from nature.



FM194



FM197

Code No.

FM194	OF 3DM Bacto-Sand - 5kg (approx. 4L)
FM194A	OF 3DM Bacto-Sand - 1kg
FM197	OF 3DM Bacto-Sand - 5kg (approx. 4L)
FM197A	OF 3DM Bacto-Sand - 1kg

Description

Specification

1.0 - 2.0mm
1.0 - 2.0mm
0.3 - 0.5mm
0.3 - 0.5mm

Packing

4 bags/carton
24 bags/carton
4 bags/carton
24 bags/carton

PRO FILTER MEDIUM - 3DM BEADS, NUGGETS, RINGS, TETRIS, OCTAS

OF 3DM Pro-Filter Medium is a revolutionary mineral based beneficial-bacteria medium that incorporates the most advanced heating and multi-staged manufacturing techniques and technology to create this super macro-porous and tough biological filter medium. It's recommended for aquarist seeking the ultimate aquarium biological filter medium.

- Largest Effective Surface Area
- Improves Water Quality
- Ideal Bacteria Conditions
- Environmentally Friendly
- Longer Water Retention Time
- Tough and Macro-Porous
- Flaking of Bio-membrane
- pH Neutral



Revolutionary Beneficial Bacteria Media

Technical Data

- Porosity : 40 – 75%
- Water Absorptivity : 30 – 78%
- Volume Density : 0.5g/cm³
- Surface Area/Volume : 2550m²/L (effective surface area)
- Spatial Aperture Range : Micro (0.10 – 10µm), Medium (10 – 500µm), Large (0.1 – 3mm)
- pH : 7 – 7.5
- Percolation Rate : 0.2 – 0.6cm / sec
- Conductivity : 40 – 145 (ppm)
- Cavity Structure : Continuous 2 – 3 dimensional cavity
- Density Range : >0.30 <0.60



Experiment:
Fine bubbles passing through fine cavities and micro-tunnels

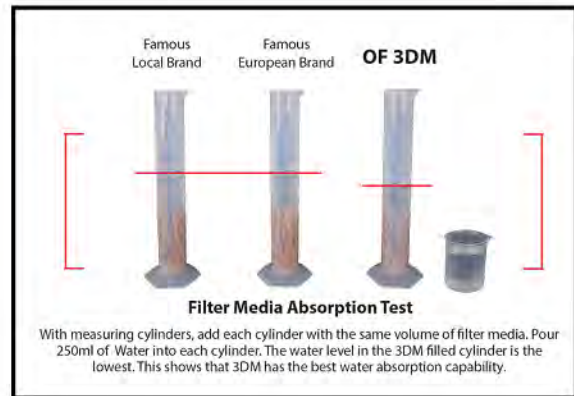
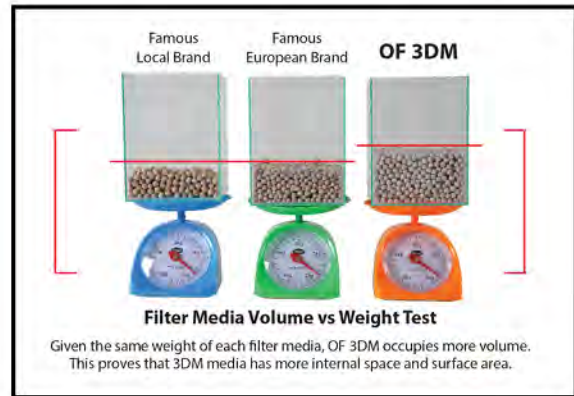

Media Type	Diagram	Dimensions
3DM Beads		A: ø7-9mm
3DM Nuggets		A: ø12-14mm (S); ø18-20mm (M) B: 10-12mm (S); 15-17mm (M)
3DM Rings		A: ø3-4mm (S); ø4-5mm (M) B: ø12-14mm (S); ø15-17mm (M) C: 8-10mm (S); 9-11mm (M)
3DM Tetris		A: ø5-6mm (S); ø13-15mm (M) B: ø30-32mm (S); ø55-57mm (M) C: 20-22mm (S); 35-37mm (M)
3DM Octas		A: ø23-25mm (L); ø27-30mm (XL) B: ø97-100mm (L); ø138-142mm (XL) C: 80-84mm (L); 80-84mm (XL)

Magnified view of exploded continuous cavities and interlinked micro-tunnels.

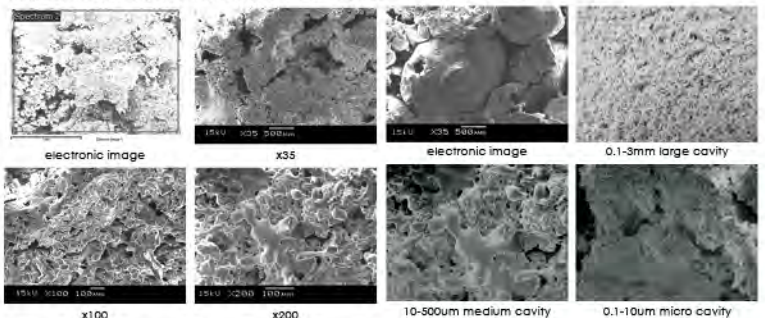

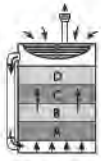

1. External Pond Filter



2. Canister Filter

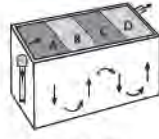

3. Box Filter

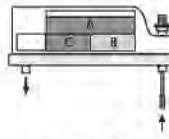

4. Top Filter

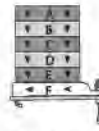

5. Multi-layer Trickle Overhead Filter

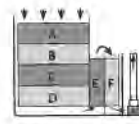

6. Sump Trickle Filter



7. Internal Filter

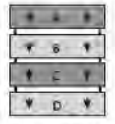

8. Baker Trickling System

FILTER LAYER TYPE OF FILTER	A	B	C	D	E	F
1. EXTERNAL POND FILTER	3DM RING (S) OR (M) 3DM NUGGETS (M) 3DM TETRIS (S)	3DM RING (S) OR (M) 3DM NUGGETS (S) OR (M)	3DM BEADS 3DM RING (S) 3DM NUGGETS (S)	BIO-FOAM BIO-MATE		
2. CANISTER FILTER	3DM RING (S) OR (M) 3DM NUGGETS (M)	3DM RING (S) OR (M) 3DM NUGGETS (S) OR (M)	3DM BEADS 3DM RING (S) 3DM NUGGETS (S)	BIO-FOAM BIO-WOOL		
3. BOX FILTER	BIO-FOAM BIO-MATE	3DM OCTAS 3DM TETRIS (XL) OR (M)	3DM RINGS (M) 3DM NUGGETS (M) 3DM TETRIS (S) OR (M)	3DM RINGS (M) 3DM NUGGETS (M) 3DM TETRIS (S)		
4. TOP FILTER	BIO-FOAM BIO-WOOL	3DM RING (S) OR (M) 3DM NUGGETS (S) OR (M)	3DM RING (S) OR (M) 3DM NUGGETS (S) OR (M)			
5. MULTI-LAYER TRICKLE OVERHEAD FILTER	BIO-FOAM BIO-WOOL	3DM RING (M) 3DM TETRIS (S) OR (M)	3DM RING (M) 3DM TETRIS (S)	3DM RING (S) OR (M) 3DM NUGGETS (M)	3DM RING (S) 3DM NUGGETS (S) OR (M)	3DM RING (M) 3DM TETRIS (S)
6. SUMP TRICKLE FILTER	BIO-FOAM BIO-WOOL	3DM RING (M) 3DM TETRIS (S) OR (M)	3DM RING (S) 3DM NUGGETS (S) OR (M)	3DM BEADS 3DM NUGGETS (S) OR (M)	3DM RINGS (S) OR (M) 3DM NUGGETS (S) OR (M) 3DM TETRIS (S)	3DM RING (S) 3DM NUGGETS (S)
7. INTERNAL FILTER	BIO-FOAM	3DM BEADS 3DM RING (S) 3DM NUGGETS (S)	3DM BEADS 3DM NUGGETS (S)			
8. BAKER TRICKLING SYSTEM	3DM TETRIS (XL) 3DM OCTAS	3DM TETRIS (XL) 3DM OCTAS	3DM RING (M) 3DM TETRIS (M) OR (XL) 3DM OCTAS	3DM RING (M) 3DM NUGGETS (M) 3DM TETRIS (M) 3DM OCTAS		

3DM Beads

Code No.	Specification	Packing
FM173A	0.5 litre	24 boxes/carton
FM173B	1 litre	12 boxes/carton
FM173C	2 litre	12 bags/carton
FM173D	5 litre	5 bags/carton
FM173E	10 litre	3 bags/carton

3DM Nuggets

Code No.	Specification	Packing
FM174A	S-0.5 litre	24 boxes/carton
FM174B	S-1 litre	12 boxes/carton
FM174C	S-2 litre	12 bags/carton
FM174D	S-5 litre	5 bags/carton
FM174E	S-10 litre	3 bags/carton
FM174F	M-0.5 litre	24 boxes/carton
FM174G	M-1 litre	12 boxes/carton
FM174H	M-2 litre	12 bags/carton
FM174I	M-5 litre	5 bags/carton
FM174J	M-10 litre	3 bags/carton

3DM Rings

Code No.	Specification	Packing
FM175A	S-0.5 litre	24 boxes/carton
FM175B	S-1 litre	12 boxes/carton
FM175C	S-2 litre	12 bags/carton

3DM Rings

Code No.	Specification	Packing
FM175D	S-5 litre	5 bags/carton
FM175E	S-10 litre	3 bags/carton
FM175F	M-0.5 litre	24 boxes/carton
FM175G	M-1 litre	12 boxes/carton
FM175H	M-2 litre	12 bags/carton
FM175I	M-5 litre	5 bags/carton
FM175J	M-10 litre	3 bags/carton

3DM Tetris

Code No.	Specification	Packing
FM176A	S-0.5 litre	24 boxes/carton
FM176B	S-1 litre	12 boxes/carton
FM176C	S-2 litre	12 bags/carton
FM176D	S-5 litre	5 bags/carton
FM176E	S-10 litre	3 bags/carton
FM176F	M-12 pieces	12 boxes/carton
FM176G	M-18 pieces	12 bags/carton
FM176H	M-48 pieces	4 bags/carton
FM176I	M-96 pieces	2 bags/carton

3DM Octas

Code No.	Specification	Packing
FM177B	L	48 pieces/carton
FM177C	XL	27 pieces/carton

3DM

PROFESSIONAL FILTER MEDIUM

Provides high surface area for beneficial bacteria which helps break-down toxic wastes like Ammonia and Nitrites biologically.

PH neutral
pH Neutral, safe for all fishes

Natural micro-flaking of Bio-Membrane
reduces clogging

Improves water quality

Porosity up to 75% and Water Absorptivity up to 78%

High effective surface area (Up to 2550m²)

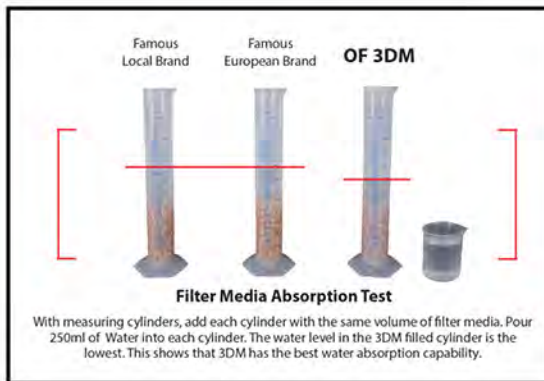
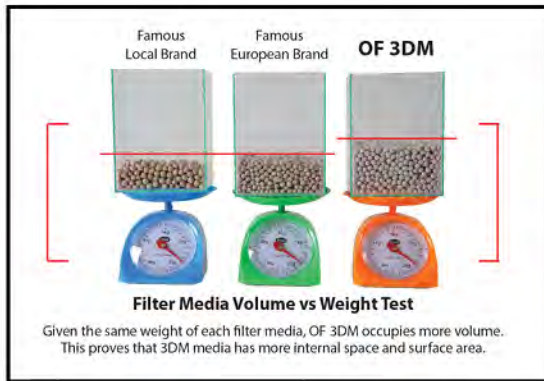

Magnified view of exploded continuous cavities and interlinked micro-tunnels.

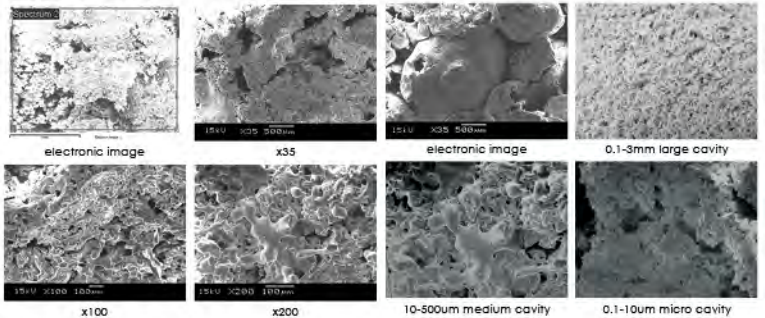

Code No.	Description	Specification	Packing
FM173G	3DM Beads	1 litre	24 bags/carton
FM174M	3DM Nugget (S)	1 litre	24 bags/carton
FM174N	3DM Nugget (M)	1 litre	24 bags/carton
FM175M	3DM Ring (S)	1 litre	24 bags/carton
FM175N	3DM Ring (M)	1 litre	24 bags/carton
FM173F	3DM Beads	2 litre	12 bags/carton
FM174K	3DM Nugget (S)	2 litre	12 bags/carton
FM174L	3DM Nugget (M)	2 litre	12 bags/carton
FM175K	3DM Ring (S)	2 litre	12 bags/carton
FM175L	3DM Ring (M)	2 litre	12 bags/carton
FM176J	3DM Tetris (S)	2 litre	12 bags/carton

Activa Block

Super-Charged Activated Carbon Block

- 01 NO MESSY PRECIPITATION**
- 02 EQUIVALENT TO 20KG* WORTH OF REGULAR ACTIVATED CHARCOAL**
- 03 ABSORPTION OF AQUARIUM WATER COLORATION, ODOURS, TOXIC POLLUTANTS**

* FOR 500G ACTIVA BLOCK.



FM195

FM196

Introduction

OF® ACTIVA BLOCK is a super-charged activated carbon block designed to maximize absorption of aquarium water coloration, odours, toxic pollutants (e.g. insecticides and chemicals) and medication. Ideal for all types of aquarium.

Highly porous natural Bamboo Activated Carbon and Sepiolite Clay minerals are precision-cut into a Cuboidal Matrix Design featuring 1400 micro-tunnels; this greatly increases its surface area and boosts its ability to draw out toxic pollutants from your aquarium water quickly and efficiently. As a result, this little 500g cube packs the equivalent absorptive capacity of 20kg worth of regular activated charcoal powder, or 40 times its body weight in absorptive power!

More Effective. Less Mess.

Comparison of the precipitation caused by regular activated carbon granules versus the clean and clear water of OF® ACTIVA BLOCK.

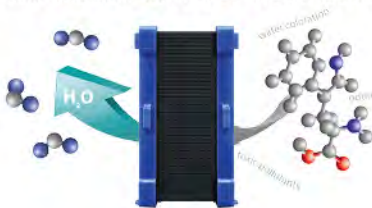

Rapid Absorption!

The Cuboidal Matrix Design featuring 1400 micro-tunnels greatly increasing the capability to absorb toxic pollutants!



Absorption Test Results

OF® ACTIVA BLOCK absorbance efficiency graph based on 250g block and 1mg Methylene Blue. Test method : US EPA Methylene Blue method

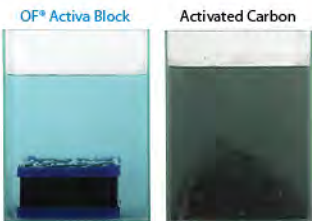
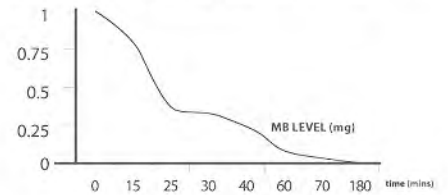

Won't Cloud Your Water



Rapid Absorption



No Messy Precipitation



Rapid sizzling caused by microbubbles from micro-cavities

Code No.	Description	Dimension	Weight	Treats Up To (L)	Packing
FM195	Activa Block - small	10 x 10 x 5cm	250g	150	36 pieces/carton
FM196	Activa Block - large	10 x 10 x 10cm	500g	300	18 pieces/carton

SUPER GRADE ACTIVATED CARBON

Classica Super Grade Activated Carbon is made of special raw material which has gone through heat treatment. This product is few times more efficient and stronger than other carbon based products in the market. It will effectively absorb chemical residue / compounds and water purifying effect. The surface area of this product can also allow providence for bacteria growth further enhancing water quality.

Code No.	Specification	Packing
FM129	150g	72 boxes/carton
FM130	300g	48 boxes/carton
FM131	500g	36 boxes/carton
FM132	1000g	12 boxes/carton



SUPER GRADE CERAMIC RINGS

Classica Super Grade Ceramic Rings are special grade ceramic rings that are made from exceptional raw material that has gone through high temperature treatment. This product is not the same as normal ceramic ring types and encompasses multi-functional purposes. It can be used to direct water flow in the filtration to spread the flow evenly. It also assists in efficient mechanical filtration purposes. Due to its high porosity nature and wide surface area, it is most ideal for beneficial bacteria growth (due to the high porous heat treated material). Tank water would be purified, stable and clean.

Code No.	Specification	Packing
FM133	250g	72 boxes/carton
FM134	500g	36 boxes/carton
FM135	1000g	12 boxes/carton



SUPER GRADE ZEOLITE

Classica Super Grade Zeolite is specially obtained from non-polluted zeolite mine. Densely rich in mineral content and will effectively remove poisonous chemical compounds like Ammonia etc. This product also will emit minerals and trace elements. Highly beneficial to ornamental fishes and aquatic plants. Its coarse porous surface is able to nurture good beneficial bacteria for best water purification and sustaining water quality.

Code No.	Specification	Packing
FM136	150g	72 boxes/carton
FM137	300g	48 boxes/carton
FM138	500g	36 boxes/carton
FM139	1000g	12 boxes/carton



SUPER GRADE ACTIVATED VOLCANIC LAVA

Classica Super Grade Activated Volcanic Lava possessed of super porous cell structure that provides large surface area for nurture of nitrifying bacteria. Resulting in outstanding filtration results. Numerous times more effective surface area as compared to similar filtration mediums. Superior mechanical and bio-logical filter medium suitable for any pond / tank filtration systems. Economical for larger filtration systems.

Code No.	Specification	Packing
FM142	150g	72 boxes/carton
FM143	300g	48 boxes/carton
FM144	500g	36 boxes/carton
FM145	1000g	12 boxes/carton



NANO TARO B.B ROLL (FAR-INFRARED EFFECT)

- Add in valuable minerals and trace elements
- Control algae growth and pathogenic bacteria
- Help to remove toxic substances and heavy metals
- Breaking water molecules and increase dissolved oxygen
- Help increase fish metabolism and expelling toxic from fishes
- Treated and baked under 1,800 Deg C
- One item, magnitude uses
- Re-vitalize water quality
- Induce fish coloration

* Suitable for pond / tank, box filter, external pond filter, canister filter, top filter, sump trickle filter, multi layer trickle overhead filter and any other filtration system.



Code No.	Specification	Packing
FM140	8 pieces/carton	12 boxes/carton
FM127	70 pieces/carton	individual

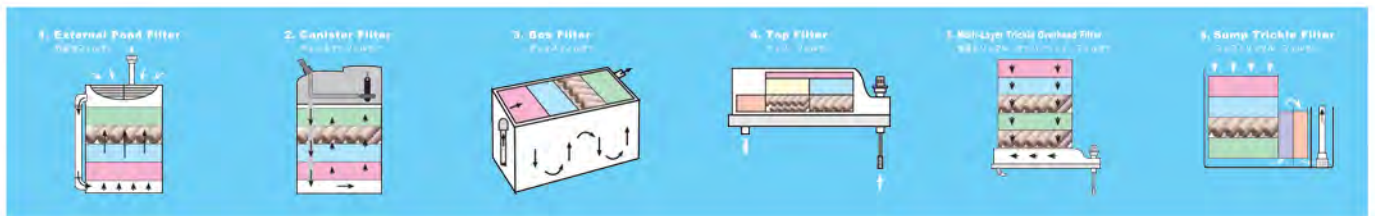

SUPER BIO-GRAVEL

- The gravel that provides superior filtering effect
- For Tropical Fishes and Plants use
- Optimum water purification can be achieve effortlessly



Code No.	Specification	Packing
AG094	5 Litre	upon request
RM240	50 Litre	individual

SUPER FILTER MEDIUM FM-1~FM-11

- The most complete and sophisticated range of Filter Medias
- Proven highly effective for mechanical, biological and chemical filtration
- Product manufactured under stringent quality control and production
- Extensive range for mix and match usage
- Ultimate solution for filter media usage



FM078



FM080



FM081



FM082



FM083



FM084



FM085



FM088



FM098

Code No.	Description	Specification	Packing
FM078	Filter Medium-1	Pro-Quartz Glass Pearls-500ml	12 boxes/carton
FM080	Filter Medium-3	Pro-Quartz Glass Rings-1000ml	12 boxes/carton
FM081	Filter Medium-4	Pro-Activated Ceramic Rings-1000ml	12 boxes/carton
FM082	Filter Medium-5	Pro-Activated Carbon-500ml	12 boxes/carton
FM083	Filter Medium-6	Pro-Effective Carbon-500ml	12 boxes/carton
FM084	Filter Medium-7	Pro-Activated Ammo-Zeolite Crystal-500ml	12 boxes/carton
FM085	Filter Medium-8	Pro-Natural Lava-500ml	12 boxes/carton
FM088	Filter Medium-10	Pro-Activated Water Softener-500ml	12 boxes/carton
FM098	Filter Medium-11	Pro-Volcanic Pearl-1000ml	12 boxes/carton

COCONUT SHELL CARBON

- Readily help to remove harmful toxic substances, odour and residue from aquaria tanks.
- Eradicate the trails of toxic heavy metal and residue of after-treatment medication.
- Create better water environment and water parameters.
- Help to control NH₃, NO₃ and other organic water.
- Change every 2-4 weeks.



Code No.	Specification	Packing
FM0211	8g x 5bags	120 pieces/carton
FM0212	25g x 2bags	120 pieces/carton

FILTER BRUSH

- Made with high quality material
- Different shape and length available
- High flexibility and performs biological / mechanical filtration as well
- Precise directing of water flow

Code No.	Specification	Packing
FM038	S - 16"	100 pieces/carton
FM039	M - 18"	100 pieces/carton
FM040	L - 24"	50 pieces/carton



SUPER ZERO COLOR

The most revolutionary aquaria water stain remover that is safe to use and with fast results.

- Ocean Free Super Zero Color can be placed in any filtration system that uses a filter box or canister
- Just lay the Ocean Free Super Zero Color pack in the filter where there would be constant water movement to achieve better results
- Ocean Free Super Zero Color can also be place directly inside the fish tank where there is water circulation
- Do change to new pack after 1 month period or when the staining of color comes back

Code No.	Specification	Packing
FM074	2 bags (S) / box	48 boxes/carton
FM075	1 bag (L) / box	36 boxes/carton



PROFESSIONAL BIO-BALL

- High quality Bio Balls made with unique shape
- Enhance bio bacteria nurturing and water flow dispersion
- High quality material for long lasting use
- Different design to suit your choice



Code No.	Description	Specification	Packing
FM099	Bio-Ball	ø38mm-Loose	1000 pieces/carton
FM100	Bio-Ball	ø38mm-100 pieces/bag	1000 pieces/carton

SUPER ACTIVATED CARBON

- Remove toxic organic substances (Ammonia, chloramines etc.) odors and colour
- Improve clarity and sparkle of water
- Five times the filtering power of charcoal
- Specially for inside, outside filter, top filter, filter box, canister filter & all filtration system

* Please use with Ocean Free "A-Z Super Beneficial Bacteria, Bio-Zyme, Super Zeolite Crystal, Bio-Foam, Ceramic Ring, Filter Wool, Bio-filter pad, Bio-plate or Bio-Ball" for Best results.



FM002A

FM003

FM006

FM008

Code No.	Specification	Packing
FM002A	100g w/net	100 packets/carton
FM003	300g w/net	36 packets/carton
FM006	1kg w/net	12 packets/carton
FM008	2kg w/net	6 packets/carton

SUPER ZEOLITE CRYSTAL

- Remove toxic organic substances (Ammonia, chloramines etc.) odors and colour
- Improve clarity and sparkle of water
- Five times the filtering power of charcoal
- Specially for inside, outside filter, top filter, filter box, canister filter & all filtration system

* Please use with Ocean Free "A-Z Super Beneficial Bacteria, Bio-Zyme, Activated Carbon, Bio-Foam, Ceramic Ring, Filter Wool, Bio-filter pad, Bio-plate or Bio-Ball" for Best results.



FM0034

FM009

FM010
FM012

FM014

Code No.	Specification	Packing
FM0034	100g w/net	100 packets/carton
FM009	300g w/net	36 packets/carton
FM010	300g x 2 w/net	24 packets/carton
FM012	1kg w/net	12 packets/carton
FM014	2kg w/net	6 packets/carton

SUPER POROUS CERAMIC RING

- It is designed for better shape & size
- It is mechanically & Biologically, effective filter material
- Enormous porous surface area is the ideal culture medium for micro-organisms, therefore, it produces out-standing filtration results

* Strongly recommended to use with Ocean Free "A-Z Super Beneficial Bacteria, Bio-Zyme, Activated Carbon, Bio-Foam, Super Zeolite Crystal, Bio-filter pad, FilterWool, Bio-plate or Bio-Ball" for Best results.



FM018

FM019

FM020

Code No.	Specification	Packing
FM014A	100g	100 packets/carton
FM015	400ml w/net	36 packets/carton
FM018	1.2litre w/net	12 packets/carton
FM019	2.4litre w/net	6 packets/carton
FM020	7litre	4 packets/carton

SUPERIOR FILTER WOOL

- Superior multiple wool types and bio-foam for all filtration usage
- For freshwater and saltwater use

- High quality, durable and re-usable
- Can be used for most major filter types

- Widest selection in the market



Code No.

Description

Specification

Packing

AW008
AW048
AW055
AW103
AW3PC
AW6PC

3 Layer Wool
Blue Fibre Wool
Hard Wool
Blue Bio Wool
New 3pcs Wool
New 6pcs Wool

3 pieces
Blue 2cm x 5 pieces
White 2cm x 6 pieces
Blue 2cm x 5 pieces
White 2cm x 3 pieces
White 2cm x 6 pieces

50 pieces/bag
10 pieces/bag
10 pieces/bag
10 pieces/bag
20 pieces/bag
10 pieces/bag

AW093
AW093A
AW093B
AW094
AW095
AW095A
AW096
AW096A
AW097

Super Bio Wool
Super Bio Wool
Super Bio Wool
Super Bio Foam
Super Bio Wool
Super Bio Wool
Super Bio Wool
Super Bio Wool
Super Bio Foam

Blue 2cm x 2 pieces
Green 2cm x 2 pieces
Green 2cm & Blue 2cm
Black 2cm & Bio-Foam 0.5cm
Blue 2cm & Bio-Foam 0.5cm
Green 2cm & Bio-Foam 0.5cm
Blue 2cm & White 2cm
Green 2cm & White 2cm
Black 2cm & White 2cm

50 pieces/bag
50 pieces/bag
50 pieces/bag
50 pieces/bag
50 pieces/bag
50 pieces/bag
50 pieces/bag
50 pieces/bag
50 pieces/bag

SUPERIOR BIO-FOAM

- Special raw material made with high durability
- Special high quality Bio-Foam
- Different sizes for all filter types
- Different shape, size and thickness
- Customization of sizes possible upon request

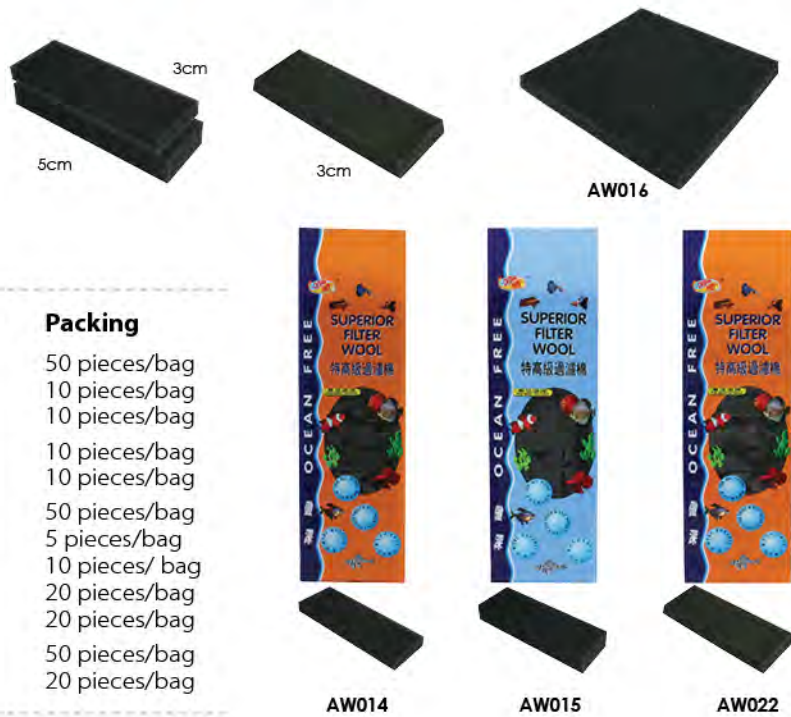

Code No.	Specification	Packing
AW014	Coarse-32.5 x 11.25 x 3cm	50 pieces/bag
AW014A	Coarse-200 x 100 x 3cm	10 pieces/bag
AW014B	Coarse-100 x 100 x 3cm	10 pieces/bag
AW014E	Fine-200 x 100 x 3cm	10 pieces/bag
AW014F	Fine-100 x 100 x 3cm	10 pieces/bag
AW015	Coarse-32.5 x 11.25 x 5cm	50 pieces/bag
AW015A	Coarse-200 x 100 x 5cm	5 pieces/bag
AW015C	Coarse-100 x 100 x 5cm	10 pieces/bag
AW016	Coarse-50 x 50 x 3cm	20 pieces/bag
AW017	Coarse-50 x 50 x 5cm	20 pieces/bag
AW022	Fine-32.5 x 11.25 x 3cm	50 pieces/bag
AW023	Fine-50 x 50 x 3cm	20 pieces/bag

GREEN / BLUE BIO-MAT

- Special quality Bio-Mat
- Made with toughened material and non toxic
- Material are tough bonded to last longer
- Highly recommended as pre-filter material
- First choice for KOI pond filtration system
- In different shape, color, thickness to suit all needs
- Customization of sizes possible upon request

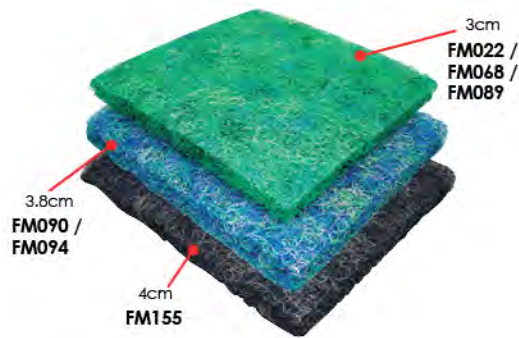

Code No.	Description	Specification	Packing
FM021	Green Bio-Mat (S)	32 x 12 x 3cm	50 pieces/bag
FM022	Green Bio-Mat (L)	200 x 100 x 3cm	10 pieces/bag
FM068	Green Bio-Mat	30 x 30 x 3cm	20 pieces/bag
FM089	Green Bio-Mat	50 x 50 x 3cm	20 pieces/bag
FM095	Blue Bio-Mat	32 x 12 x 3.8cm	50 pieces/bag
FM090	Blue Bio-Mat (L)	200 x 100 x 3.8cm	10 pieces/bag
FM094	Blue Bio-Mat	50 x 50 x 3.8cm	20 pieces/bag
FM155	Kagayaki-Bio-Mat	200 x 100 x 4cm	10 pieces/bag



SUPERIOR FILTRATION WOOL

- Different grades of loose wool for filtration purposes
- Washable and ideal for mini air powered filters



AW006A



AW006

Code No.	Description	Specification	Packing
AW006A	Uncut Wool	36.58m (L) x 1.5m (W)	36.58m/roll
AW006	Rectangular Wool	110cm (L) x 45cm (W)	20 pieces/bag

BLUE / GREEN / WHITE COARSE WOOL

- High quality coarse filter wool for mechanical and biological filtration
- Durable and re-usable
- Customization of sizes possible upon request

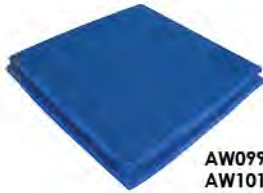

AW099 / AW101

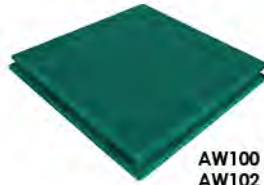

AW100 / AW102

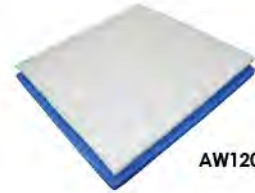

AW120

Code No.	Description	Specification	Packing
AW099	Blue Coarse Wool	200 x 100 x 2cm	5 pieces/bag
AW100	Green Coarse Wool	200 x 100 x 2cm	5 pieces/bag
AW101	Blue Coarse Wool	50 x 50 x 2cm	20 pieces/bag
AW102	Green Coarse Wool	50 x 50 x 2cm	20 pieces/bag
AW120	White / Blue Coarse Wool	50 x 50 x 2cm	20 pieces/bag

FILTER WOOL & WHITE WATT

- Different combination of high quality Bio Foam and Wool



EM074



EM075

Code No.	Description	Specification	Packing
EM074	White Watt	2222/4 x 3 pieces	50 pieces/bag
EM075	White Watt	2226/8 x 3 pieces	50 pieces/bag

WHITE NET-FINE (3 Wire)

- High quality and durable fish nets for general purposes
- Comes in coarse or fine netting
- In different shape and sizes



Code No.	Specification	Packing
FN017	3"	600 pieces/carton
FN002	4"	480 pieces/carton
FN004	5"	420 pieces/carton
FN006	6"	360 pieces/carton
FN008	8"	218 pieces/carton
FN010	10"	180 pieces/carton
FN011	12"	168 pieces/carton

GREEN NET-MEDIUM (3 Wire)

- High quality and durable fish nets for general purposes
- Comes in coarse or fine netting
- In different shape and sizes



Code No.	Specification	Packing
FN017A	3"	600 pieces/carton
FN001	4"	480 pieces/carton
FN003	5"	420 pieces/carton
FN005	6"	360 pieces/carton
FN007	8"	216 pieces/carton
FN009	10"	180 pieces/carton
FN012	12"	168 pieces/carton

SUPER 2-IN-1 GRAVEL CLEANER

The Gravel Cleaner Pump features an interchangeable nozzle which allows hobbyist to perform a thorough vacuuming of the gravel or a general water change. A specially designed mechanism increases its ability to suck out tank water fast and steadily. The Super 2-in-1 Gravel Cleaner is a must have maintenance tool for all aquarium tanks.

- Interchangeable nozzle for gravel cleaning or general water changes
- Suction cup at nozzle to make water changing more convenient
- Increased length; suitable for all aquarium tanks
- Special mechanism for increased suction
- Designed for added durability



Code No.	Specification	Packing
AF074	Special Mechanism	60 pieces/carton

CHANGE WATER PIPE

- High quality PVC water change kit
- Easy to use and water valve installed for flow control



Code No.	Specification	Packing
AA169	Water Change Kit	36 pieces/carton

SUPER TOTAL GLASS CLEANER

- General tank cleaning brush
- Made with high quality material and durable



Code No.	Specification	Packing
SP036	Blue	120 pieces/carton

ALGAE SCRAPER

- Rotatable Algae Scraper Cleans and removes algae and other impurities from aquarium glass.
- Rotatable mechanism allows for ease of use and cleans hard to reach areas
- Blade Scraper Helps to remove the most stubborn algae and stains without scratching your glass surface
- Gravel Flattener helps to keep substrate and aquascape neat



Code No.	Specification	Packing
SP038	48cm	80 pieces/carton
SP039	59cm	80 pieces/carton

TANK TAG SMART LCD THERMOMETER

The design uses precision technology smart microcontrollers and external metallic tab sensor for measuring water temperature from the tank external glass pane and displaying the readings on a clear LCD panel. Strong 3M double sided tape is provided for sticking the product onto the external glass pane of the Aquarium. The metallic tab sensor sticking onto the glass pane will sense the temperature of the water inside the aquarium through the glass external pane.



Code No.	Specification	Packing
AM0053	Magnet Type	100 pieces/carton

DIGITAL THERMOMETER CARD

- High quality sticker thermometer
- Accurate and easy to use
- Clear indication

Code No.	Specification	Packing
AM003	Sticker Type	1200 pieces/carton



PH PEN / TESTER

Classica pH Pen / Tester adopted the latest micro-electronic circuit design to provide high performance, stable and accurate measurement. pH Pen / Tester is widely use in laboratory for chemical analysis, aquaculture, horticulture and fish hobbyist.

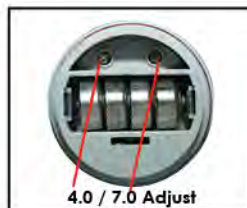

Code No.	Specification	Packing
AM047	Water Resistant	100 pieces/carton

NANO LCD Auto Fish Feeder

- LCD Screen & Timer
- Manual Feed Function
- Adjustable Feed Quantity
- 4 Auto Feeding Modes
- Air Pump Function

Classica Nano LCD Auto Fish Feeder is an easy to use automatic pellet dispenser designed with an easy-to-read LCD display, user - friendly digital controls and multiple feeding modes. It is a perfect product to all hobbyists who are busy or away for holidays and have no time to feed your fishes regularly.



Install The Feeder :



Stickup



Fix onto Glass



Clean Air Inlet



2 AA Batteries (included)

Code No.	Description	Specification	Packing
FD023	Nano LCD Auto Fish Feeder	4 Feeding Modes	24 pieces/carton

SUPER AUTOFEEDER Battery Operated Aquarium Feeder

- 3 feeding modes
- Perfect for flake, pellet and tablet food
- Holds approximately 30 days of food
- Easy to select required Feed Amount
- Clamp and suction-cups mount included



Code No.	Specification	Packing
FD022	Easily Adjustable Feed Valve	24 pieces/carton

XL FOOD TIMER

- Feed up to 6 times per day
- Select from 48 available time slots
- Upsized feed quantity
- Manual Function

FOOD TIMER

- Preset feeding schedule up to 6 times per day
- Manual feeding as and when desired



Code No.	Specification	Packing
FD018	6 times per day preset feeding	12 pieces/carton
FD024	6 times per day preset feeding	12 pieces/carton

BETTA STRIKE

Stimulate Your Betta's Natural Territorial Behavior !

- Provide daily workout session for Betta
- Helps develop full fins in juvenile Betta
- Gives your Betta a motivational boost

OF® Betta Strike workout mirror, gives your beloved Betta a few minutes of muscle flexing daily and giving your Betta a motivational boost as it 'chases' away his mirror opponent. It is also an important daily workout session for juveniles for full fins development.



Fix the suction cup to a clean, smooth surface (tank's external or internal); lightly wet the suction cup for a better grip.

Code No.	Specification	Packing
AA204	Workout Mirror For Betta	48 pieces/carton

SMART FILTER MEDIUM BAG (RECTANGULAR)

- Super strong & durable
- For Fresh and Salt Water
- For any type of filter & filter box
- Washable
- For any type of filter medium
- Available in various size & shape

Code No.	Specification (WxL)	Packing
FB012	20 x 28cm-Fine	48 pieces/carton
FB013	26 x 33cm-Fine	48 pieces/carton
FB014	26 x 33cm-Medium	48 pieces/carton
FB015	29 x 38cm-Fine	48 pieces/carton
FB016	29 x 38cm-Medium	48 pieces/carton
FB017	32 x 43cm-Fine	48 pieces/carton
FB018	32 x 43cm-Medium	48 pieces/carton
FB019	38 x 48cm-Medium	48 pieces/carton



PROFESSIONAL FILTER MEDIUM BAG

- Washable
- For Fresh and Salt Water
- For any type of filter & filter box
- Super strong & durable
- For any type of filter medium
- Available in various size & shape

Code No.	Description	Specification	Packing
FB001	Rectangular	□ 26 x 36cm	48 pieces/carton
FB002	Rectangular	□ 37 x 57cm	48 pieces/carton
FB003	Rectangular	□ 48 x 65cm	36 pieces/carton
FB004	Round	∅ 19 x 33cm	48 pieces/carton
FB005	Round	∅ 22 x 40cm	48 pieces/carton
FB006	Round	∅ 40 x 65cm	36 pieces/carton



SPECIAL HEAVY DUTY PLASTIC BAG

- Heavy duty fish packaging bag
- Available in different sizes (can be customized)
- Special corner seal
- Reduce unnecessary loses



* can withstand more than 20kg tension



* can withstand more than 25kg compression



* Drop Test: ≥ 5ft per layer

Corner Seal

Code No.	Thickness	Specification (WxL)	Packing
PB6	0.06mm	6" (15cm) x 18" (45cm)	20 kgs/bag
PB8	0.06mm	8" (20cm) x 24" (60cm)	20 kgs/bag
PB10L	0.06mm	10" (25cm) x 28" (70cm)	20 kgs/bag
PB11	0.06mm	11" (27.5cm) x 30" (75cm)	20 kgs/bag
PB12	0.06mm	12" (30cm) x 30" (75cm)	20 kgs/bag
PB14	0.06mm	14" (35cm) x 30" (75cm)	20 kgs/bag
PB16	0.06mm	16" (40cm) x 32" (80cm)	20 kgs/bag
PB18	0.06mm	18" (45cm) x 32" (80cm)	20 kgs/bag

MULTI-GLASS SUCTION / SUCTION CUP

- High quality rubber suction cup / clip / hole
- Sticks readily to glass surface



GS1003



UP1403

Code No.	Description	Specification	Packing
GS1003	Multi Glass Suction	M-17mm	500 pieces/bag
UP1403	Suction Cup	9.3mm	2000 pieces/bag

ECOFRESH

Automatic Pond Feeder

- AC / DC Power Supply
- Digital Control Panel
- 6 Programmable Feed Times
- Adjustable Feed Duration
- Manual Feed Mode
- Wide Area of Coverage
- Suitable with Different Pellet Sizes
- Easy to Use
- Low Power Consumption
- Safe

* Suitable for Pellets from

3mm → 7mm



Product Features

- **AC / DC Power Supply.** Never worry about batteries going flat again!
- **Digital Control Panel.** User friendly and easy to program.
- **6 Programmable Feed Times.** Keep your fish well fed throughout the day with up to 6 programmable feeding times per day.
- **Adjustable Feed Duration.** Choose between 5 different feeding durations to determine the amount of pellets to be dispensed during each feeding session.
- **Manual Feed Mode.** Activate the manual feed mode to dispense pellets any time you like!
- **Wide Area of Coverage.** The Spindle Brush distributes pellets over a wide feed coverage area.
- **Suitable with Different Pellet Sizes.** Compatible with pellet feed from 3mm – 7mm.
- **Easy to Use.** User-friendly control panel with digital LED display.
- **Low power consumption.** Energy saving design and components.
- **Safe.** DC low voltage operation.



Dispenser



LCD Display Panel

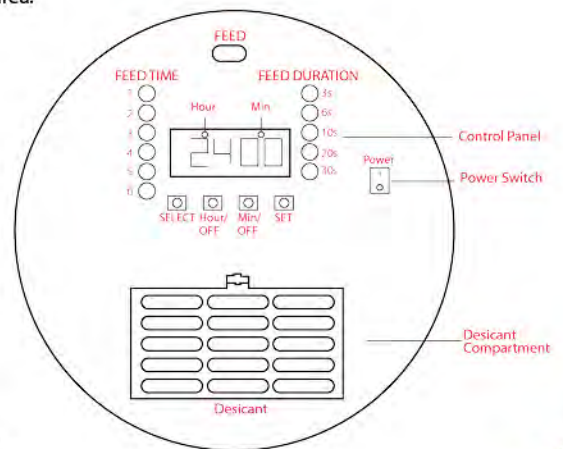

Code No.
PDA0008

Dimension
320 x 250 x 350mm

Max Feed Volume
12L

Power Supply
12V 1A DC Power Adapter

Packing
4 pieces/carton

UVLAB

Quality pond UV sterilizer / water clarifier

- Clears green water without chemical use
- Tough and Durable Design
- Easy installation and maintenance
- Safe for pond livestock and filter bacteria
- Multiple fittings provided for flexibility in application
- Can be installed with existing filtration system
- Kills harmful suspended bacteria pathogens and fungal spores

Features:

Pondpro UVLAB is designed and built to eliminate green water problems as well as

- UV Lab clears green water fast without chemical use by killing free floating algae (with UVC); the equipment is designed to keep your livestock and filter bacteria safe
- Highly effective in disease prevention and improving overall water conditions by eliminating harmful free floating bacteria pathogens & fungal spores
- Helps in preventing parasite infestation by killing free floating parasites that is exposed to the UVC
- Designed to increase exposure / dwell time for added efficiency
- Multiple fittings provided for flexibility in application
- Can be easily fitted to your existing pond filtration system
- Easy installation and maintenance
- Stainless Steel body for extra toughness and durability, its reflective nature also improves effectiveness of UVC by 50% and more



Stainless Steel body for extra toughness and durability, its reflective nature also improves effectiveness of UVC by 50% and more.



Code No.	Description	Recommended Tank / Pond Size	Power	Packing Consumption
PDU0001	UVLAB-15W	Up to 10000 L	15W	6 pieces/carton
PDU0002	UVLAB-25W	Up to 20000 L	25W	4 pieces/carton
PDU0003	UVLAB-30W	Up to 30000 L	30W	4 pieces/carton
PDU0004	UVLAB-55W	Up to 55000 L	55W	4 pieces/carton

AIRLAB

High performance air pump for pond & aquariums

- Provides Strong & Constant Aeration
- Noise & Vibration Dampening Design
- Tough, Durable Body & Mechanics
- Low Energy Consumption

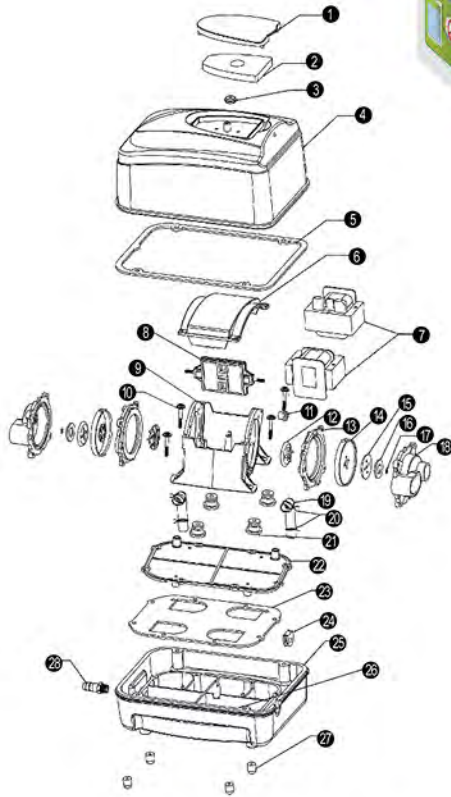

- | | |
|-------------------------|-----------------------|
| 1. Air Inlet Cover | 15. Diaphragm Meson |
| 2. Filter Wool | 16. O-Ring |
| 3. Air Inlet Button | 17. Nut |
| 4. Upper Casing | 18. Diaphragm Casing |
| 5. Silencer | 19. Rubber Hose |
| 6. Motor Cover | 20. Clip |
| 7. Magnetic Coil | 21. Supporting Stud |
| 8. Actuating Rod | 22. Motor Base Plate |
| 9. Motor Base | 23. Seal |
| 10. Screw | 24. Outer Wire Guide |
| 11. Inner Wire Guide | 25. Bottom Casing |
| 12. Actuating Rod Meson | 26. Inner Filter Wool |
| 13. Diaphragm Base | 27. Pump Stud |
| 14. Diaphragm | 28. Air Outlet |



PDA0001

PDA0002

PDA0003

PDA0004

PDA0005

PDA0006

Code No.	Description	Max. Flow (L/Min)	Common Pressure	Power Consumption	Packing
PDA0001	EV20	30 L/MIN	0.025Mpa	20W	6 pieces/carton
PDA0002	EV40	45 L/MIN	0.025Mpa	25W	6 pieces/carton
PDA0003	EV60	65 L/MIN	0.046Mpa	45W	4 pieces/carton
PDA0004	EV80	85 L/MIN	0.046Mpa	55W	4 pieces/carton
PDA0005	EV100	105 L/MIN	0.048Mpa	60W	2 pieces/carton
PDA0006	EV120	120 L/MIN	0.048Mpa	70W	2 pieces/carton

AIRLAB BABY

Compact pond air pump

- Increases Dissolved Oxygen (DO) Levels In Your Pond
- Provides Strong Supply of Air Up To 1.80M Deep
- Weatherproofed Body Designed for Outdoor Use
- Low Energy Consumption

Features:

The AIRLAB BABY is a compact outdoor air pump that aerates your pond and increases your pond's dissolved oxygen level, keeping your fish healthy and lively.



1. Compact design with twin outlets
2. Weatherproofed body designed for outdoor use
3. Adjustable dial to control air output
4. Strong air supply for air stones up to 1.80m deep
5. 10m airline, check valve and air stones included
6. Low energy consumption

Code No.	Max. Output (LPH)	Max Pressure	Power Consumption	Packing
PDA0007	2 x 360 LPH	0.028Mpa	10W	12 pieces/carton

RAPIDPUMP

High performance amphibious pump

- Provides Strong & Constant Water Flow
- Energy-saving Inverter Technology
- Tough Closed Impeller & Rotor system
- Silent, Tough and Durable Design
- Low Energy Consumption
- Wet or Dry Mount



PDP0001



PDP0002



PDP0003



PDP0004



PDP0005

1. Prefilter
2. Hosetail Nut
3. Hosetail
4. 'O' Ring
5. Screws
6. Pump Body Cover (Impeller Mounting Block)
7. 'O' Ring
8. Closed Impeller & Rotor Assembly
9. Pump Body
10. Base Plate
11. Rubber Leg

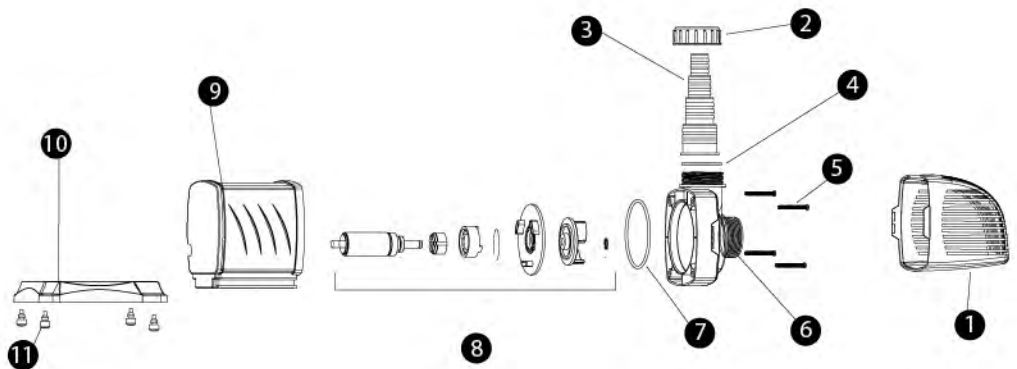

Code No.	Description	Max. Flow (L/H)	H/Max. (M)	Power Consumption	Packing
PDP0001	3500	3500 L/H	3m	25W	6 pieces/carton
PDP0002	5000	5000 L/H	3.5m	45W	6 pieces/carton
PDP0003	6500	6500 L/H	4m	50W	6 pieces/carton
PDP0004	8000	8000 L/H	4.5m	75W	4 pieces/carton
PDP0005	10000	10000 L/H	5m	85W	4 pieces/carton

RAPID SHIELD

High performance amphibious pump with cage pre-filter

- Robust Pump Cage Pre-filte
- Provides Strong & Constant Water Flow
- Energy-saving Inverter Technology
- Tough Closed Impeller & Rotor system
- Silent, Tough and Durable Design
- Low Energy Consumption

Features:

Pondpro RAPID SHIELD is designed and built to provide reliable pumping performance in challenging conditions.

- Tough and durable design for high performance water output.
- Robust ribbed Pump Cage Pre-filter offers excellent protection against clogging by filtering out solid particles (>8mm) and fallen leaves, significantly extending pump performance and durability.
- Tough Closed Impeller & Rotor system delivers high performance with added durability.
- Interchangeable Parts allows easy replacement of parts to maintain performance level.
- Eco-friendly Invertor Technology reduces energy consumption.



PDP0006

PDP0007

PDP0008

PDP0009

PDP0010

Code No.	Description	Max. Flow (L/H)	H/Max. (M)	Power Consumption	Packing
PDP0006	3500	3500 L/H	3m	25W	2 pieces/carton
PDP0007	5000	5000 L/H	3.5m	45W	2 pieces/carton
PDP0008	6500	6500 L/H	4m	50W	2 pieces/carton
PDP0009	8000	8000 L/H	4.5m	75W	2 pieces/carton
PDP0010	10000	10000 L/H	5m	85W	2 pieces/carton



Reptile Paradise



RTA0007



RTA0003



• Top Cover



Locking Clip

• Cover Feeding Flap



• Front Openable Viewing Panel

FEATURES

- Strong and sturdy structure
- High clarity acrylic viewing panels and walls that provides easy viewing of your pets' activities
- Built-in reptile UVA + UVB basking lamp to provide necessary spectrum and warmth for healthy reptile growth
- Specially designed water discharge system for ease of maintenance.
- Ideal for amphibious pets, e.g. terrapins, frogs, etc.
- Several ventilation and air holes to ensure interior is well-ventilated
- Easy to clean.
- Optional: Removable climbing platform that doubles as basking platform.
- Optional: Heater and Filtration add-ons available.



Code No.

RTA0003
RTA0007

Description

Reptile Paradise 400
Reptile Paradise 600

Specification

400 x 325 x 275mm
600 x 370 x 350mm

Packing

Individual
Individual

- SUITABLE FOR -

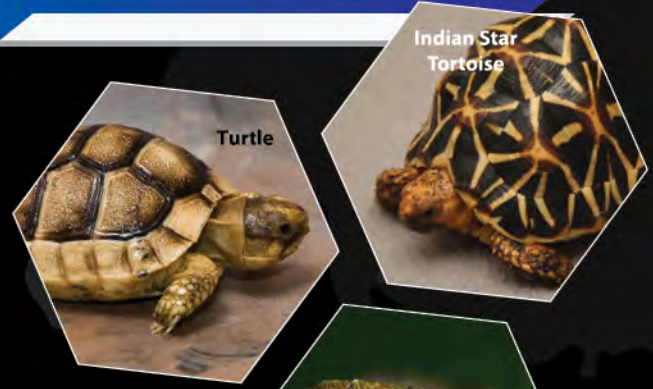

Reptile Paradise Platform



Ramp allows your turtle to easily climb onto the basking platform.



Recommended for turtles and amphibians.



Available in 3 exciting options depending on your needs.



for models with filter



for models with hydra



for models with heater

Code No.	Description	Specification	Packing
RTA0011	Reptile Paradise Platform S	Platform only	18 pieces/carton
RTA0012	Reptile Paradise Platform S	Filter only	18 pieces/carton
RTA0013	Reptile Paradise Platform S	Hydra only	18 pieces/carton
RTA0014	Reptile Paradise Platform S	Filter & Heater 25W	18 pieces/carton
RTA0015	Reptile Paradise Platform S	Filter & Heater 50W	18 pieces/carton
RTA0016	Reptile Paradise Platform S	Filter & Heater 75W	18 pieces/carton
RTA0017	Reptile Paradise Platform S	Filter & Heater 100W	18 pieces/carton
RTA0018	Reptile Paradise Platform S	Hydra & Heater 25W	18 pieces/carton
RTA0019	Reptile Paradise Platform S	Hydra & Heater 50W	18 pieces/carton
RTA0020	Reptile Paradise Platform S	Hydra & Heater 75W	18 pieces/carton
RTA0021	Reptile Paradise Platform S	Hydra & Heater 100W	18 pieces/carton
RTA0022	Reptile Paradise Platform L	Platform only	18 pieces/carton
RTA0023	Reptile Paradise Platform L	Filter only	18 pieces/carton
RTA0024	Reptile Paradise Platform L	Hydra only	18 pieces/carton
RTA0025	Reptile Paradise Platform L	Filter & Heater 25W	18 pieces/carton
RTA0026	Reptile Paradise Platform L	Filter & Heater 50W	18 pieces/carton
RTA0027	Reptile Paradise Platform L	Filter & Heater 75W	18 pieces/carton
RTA0028	Reptile Paradise Platform L	Filter & Heater 100W	18 pieces/carton
RTA0029	Reptile Paradise Platform L	Hydra & Heater 25W	18 pieces/carton
RTA0030	Reptile Paradise Platform L	Hydra & Heater 50W	18 pieces/carton
RTA0031	Reptile Paradise Platform L	Hydra & Heater 75W	18 pieces/carton
RTA0032	Reptile Paradise Platform L	Hydra & Heater 100W	18 pieces/carton

TURTLE ISLAND

Magnetic Floating Platform

- Natural looking basking area for aquatic turtles.
- Stable mounting allows aquatic turtles to climb easily.
- Magnetic mount that's easy to install, adjust and move!
- Tough and durable material.



Specification

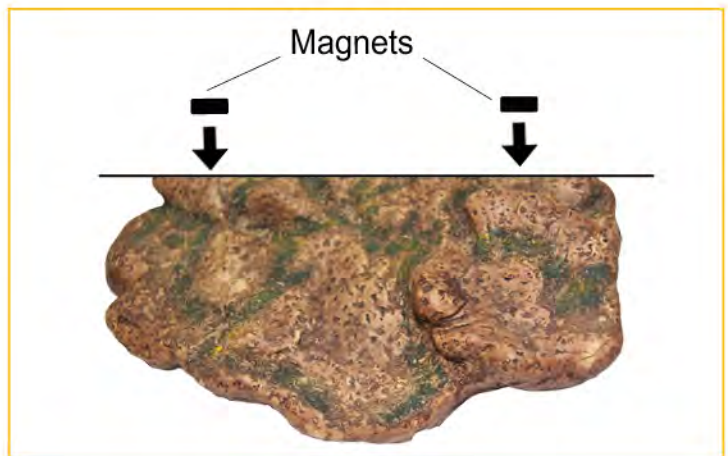
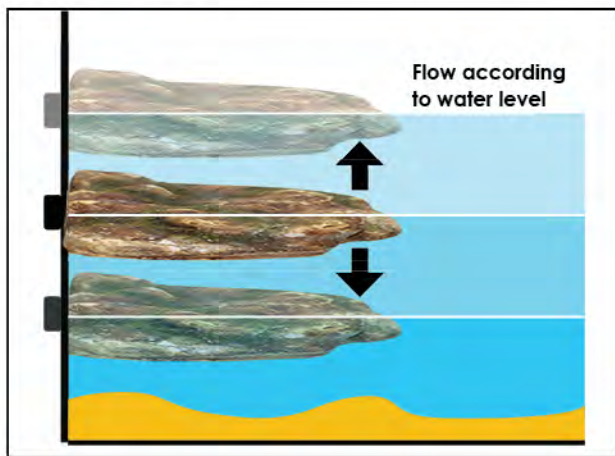

Code No.

RTA0001
RTA0002

Description

Reptilepro Turtle Island - S
Reptilepro Turtle Island - L

Specification

18.5 x 13 x 4.7cm
29.5 x 18 x 6.8cm

Packing

48 pieces/carton
12 pieces/carton

AMPHIBEAM SOLAR LAMP-2.0UVB

- Full UV spectrum of natural sunlight is stimulated
- 2% UVB
- Immense visual light output
- Recommended spectrum for all reptiles & amphibians
- Through UVA radiation, reptiles's appetite and reproductive behavior are stimulated



Code No.	Specification	Packing
RTT0001	13W	12 pieces/carton
RTT0002	26W	12 pieces/carton

AMPHIBEAM RAINFOREST LAMP-5.0UVB

- Provides high UVB output (5% UVB)
- Highly recommended to combine with Reptile Pro Solar 2.0 for a higher visual light output
- Recommended spectrum for all tropical reptiles
- UVB rays provided are essential for calcium metabolism



Code No.	Specification	Packing
RTT0003	13W	12 pieces/carton
RTT0004	26W	12 pieces/carton

AMPHIBEAM DESERT LAMP-10.0UVB

- Recommended for all desert dwelling reptiles
- Highly recommended to combine with Reptile Pro Solar 2.0 for a higher visual light output
- Extremely high UVB output (10%)
- UVB rays provided are essential for calcium metabolism



Code No.	Specification	Packing
RTT0005	13W	12 pieces/carton
RTT0006	26W	12 pieces/carton

HELIOSBEAM SIMULATING LAMP

- Full UV spectrum of natural sunlight is simulated
- UVB penetration distance is increased
- Assists in prevention of metabolic bone disease
- Self-ballasted mercury vapour bulb

Code No.	Specification	Packing
RTT0028	125W	12 pieces/carton
RTT0029	160W	12 pieces/carton



DAYLIGHT HEAT LAMP

- Provides heat for thermoregulation
- Mimics heat and light of the sun
- Reptiles are provided with UVA rays

Code No.	Specification	Packing
RTT0030	50W	12 pieces/carton
RTT0031	75W	12 pieces/carton
RTT0032	100W	12 pieces/carton



DAYLIGHTBEAM BASKING LAMP

- Reptiles are provided with UVA rays
- Lamp provides heat for thermoregulation
- Mimics heat and light of the sun
- Create temperature gradients

Code No.	Specification	Packing
RTT0033	50W	12 pieces/carton
RTT0034	75W	12 pieces/carton
RTT0035	100W	12 pieces/carton



INTENSIFIED DAYLIGHT BEAM

- Reptiles are provided with UVA rays
- Enhances breeding behavior through UVA rays
- Provides a perfect basking area for thermoregulation
- Lamp provides heat for thermoregulation

Code No.	Specification	Packing
RTT0036	50W	12 pieces/carton
RTT0037	75W	12 pieces/carton
RTT0038	100W	12 pieces/carton



LUNAR-RED BASKING LAMP

- Heat is provided which is essential for digestion and daily activity
- Overall temperature in the terrarium will be increased
- Perfect for nocturnal (night) viewing
- Desirable all day heat source

Code No.	Specification	Packing
RTT0039	50W	12 pieces/carton
RTT0040	75W	12 pieces/carton
RTT0041	100W	12 pieces/carton



REPTILE LAMP FIXTURE

REPTILE CLAMPING LAMP

- Dual-usage fixture; for basking or lighting
- Spring clamp allows lamp to be firmly attached to terrariums
- Black external coat with white inner coat
- Compact size
- Porcelain lamp-holder



RTT0042



RTT0043



RTT0044

REPTILE HANGING LAMP

- Hanging fixture provides flexible solution for bigger enclosures
- Polished inner surface intensifies the UVB and UVA output
- Recommended for use with Reptile Pro Rainforest 5.0 & Reptile Pro Desert 10.0
- Porcelain lamp-holder



RTT0045



RTT0046

REPTILE WIRE CLAMPING LAMP

- Strong wire design protects the bulb while preventing excessive buildup of heat from heating lamps
- Spring clamp allows lamp to be firmly attached to terrariums
- Compact size
- Porcelain lamp-holder



RTT0047



RTT0048

Code No.

RTT0042
RTT0043
RTT0044
RTT0045
RTT0046
RTT0047
RTT0048

Description

Reptile Clamping Lamp M75
Reptile Clamping Lamp M150
Reptile Clamping Lamp M200
Reptile Hanging Lamp M100
Reptile Hanging Lamp M160
Reptile Wire Clamping Lamp M250
Reptile Wire Clamping Lamp M150

Specification

Up to 75W
Up to 150W
Up to 200W
Up to 100W
Up to 160W
Up to 250W
Up to 150W

Packing

12 pieces/carton
12 pieces/carton
6 pieces/carton
12 pieces/carton
6 pieces/carton
12 pieces/carton
12 pieces/carton

AMPHIBEAM SOLAR LIGHTING-2.0UVB

- 2% UVB
- Immense visual light output
- Full UV spectrum of natural sunlight is stimulated
- Recommended spectrum for all reptiles & amphibians
- Through UVA radiation, reptiles's appetite and reproductive behavior are stimulated



Code No.	Specification	Packing
RTT0007	15" / 14W	24 pieces/carton
RTT0008	18" / 15W	24 pieces/carton
RTT0009	24" / 20W	24 pieces/carton
RTT0010	30" / 25W	24 pieces/carton
RTT0011	36" / 30W	24 pieces/carton
RTT0012	42" / 40W	24 pieces/carton
RTT0013	48" / 40W	24 pieces/carton



AMPHIBEAM RAINFOREST LIGHTING-5.0UVB

- Provides high UVB output (5% UVB)
- Recommended spectrum for all tropical reptiles
- Highly recommended to combine with Reptile Pro Solar 2.0 for a higher visual light output
- UVB rays provided are essential for calcium metabolism



Code No.	Specification	Packing
RTT0014	15" / 14W	24 pieces/carton
RTT0015	18" / 15W	24 pieces/carton
RTT0016	24" / 20W	24 pieces/carton
RTT0017	30" / 25W	24 pieces/carton
RTT0018	36" / 30W	24 pieces/carton
RTT0019	42" / 40W	24 pieces/carton
RTT0020	48" / 40W	24 pieces/carton



AMPHIBEAM DESERT LIGHTING-10.0UVB

- Recommended for all desert dwelling reptiles
- Extremely high UVB output (10%)
- Highly recommended to combine with Reptile Pro Solar 2.0 for a higher visual light output
- UVB rays provided are essential for calcium metabolism

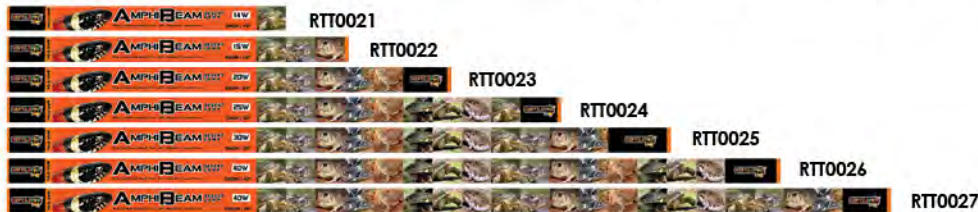

Code No.	Specification	Packing
RTT0021	15" / 14W	24 pieces/carton
RTT0022	18" / 15W	24 pieces/carton
RTT0023	24" / 20W	24 pieces/carton
RTT0024	30" / 25W	24 pieces/carton
RTT0025	36" / 30W	24 pieces/carton
RTT0026	42" / 40W	24 pieces/carton
RTT0027	48" / 40W	24 pieces/carton



REPTILE ECO HEATER

Fully automatic and adjustable aquarium heater for up to 155L. Water temperature is fully in consistent and heat is evenly distributed throughout. Easy to use even for novice fish hobbyist.

- Automatically maintains temperature selected throughout the tank
- Temperature dial is easy to read and set
- Reliable and steadily built structure guarantees effectiveness
- Visible ON / OFF indicator lamp
- Special glass tube is highly resistant against heat and shock
- Totally submersible in tank
- Special adhesive suckers and clip to keep heater in place firmly

IP68 RoHS CE



RTH0006 RTH0005 RTH0004 RTH0003 RTH0002 RTH0001

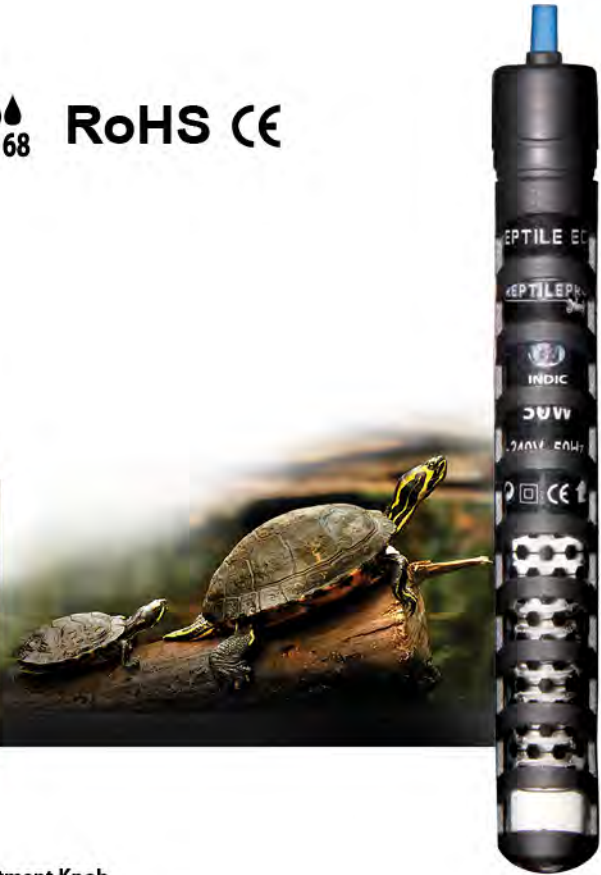

- 1. Temperature Adjustment Knob**
For easy adjustment of ideal temperature.
- 2. Double Sealing**
Safety double sealing to ensure non leak.
- 3. Heating Indicator Light**
Visible and clear heating indicator light.
- 4. Strong Suction**
Made with high quality rubber, these suction pads provide grip.
- 5. Strong Glass Tube**
Super strong glass tube that can withstand temperature changes and would not break easily.
- 6. Heater Guard**
To protect glass from impact.

Code No.

Specification

Packing

RTH0001	25W	48 pieces/carton
RTH0002	50W	48 pieces/carton
RTH0003	100W	48 pieces/carton
RTH0004	150W	48 pieces/carton
RTH0005	200W	48 pieces/carton
RTH0006	300W	48 pieces/carton



Marine Crystal

Enriched Sea Salt

Superior salt formulation for reef and marine aquariums.
Zero Nitrate. Zero Phosphate.

Ionic Composition at 35ppt (Natural Seawater Salinity)

Ion : Concentration in mg / L

KH : 180ppm for a salinity of 1024

Calcium : 450 | **Magnesium** : 1360

Potassium : 400 | **Strontium** : 11.1

RevoReef® MARINE CRYSTAL synthetic sea salt is specially formulated for closed reef systems and is enriched with an additional measure of components essential to reef hobbyists :

- Additional Calcium
- Additional Trace Elements
- Additional Strontium
- Additional Magnesium
- KH Buffers

Mixing Instructions

- Mix MARINE CRYSTAL with dechlorinated water. RO or DI water is preferred.
- Use a calibrated Salinity Refractometer to measure salinity.
Recommended specific gravity range for reef tank with hard coral : 1.024 at 24°C.

Important

- Never mix salt in an aquarium containing animals.
- Contact in dry form may cause skin or eye irritation.
In case of contact, flush immediate with plenty of water.
- Keep out of reach of children.
- Not for human consumption.



20KG

Ionic Composition at 35ppt (Natural Seawater Salinity)

Ion	KH	Calcium	Magnesium	Potassium	Strontium
Concentration in mg/L	180ppm for a salinity of 1024	450	1360	400	11.1

Code No

RRS0007

Description

Marine Crystal Enriched Sea Salt

Weight

20kg

Packing

Individual



RevoReef®



pH Buffer 8.1-8.4

3DM Reef Sand

Pest Free, Bacteria Free, Parasite Free, Virus Free, Eco Coral Sand

RevoReef® 3DM Reef-Sand is a revolutionary mineral-based eco 'coral-sand' recommended for the eco-friendly aquarist seeking the ultimate pest-free, bacteria-free, parasite-free, virus-free marine 'coral-sand'.
100% safe and 100% ready to use.



RevoReef® 3DM REEF-SAND

pH	: 8.1 – 8.4
Surface Area/Volume	: 2550m ² /L (effective surface area)
Spatial Aperture Range	: Micro (0.10 - 10µm), Medium (10-500 µm), Large (0.1 – 3mm)

RevoReef® 3DM Reef-Sand is a revolutionary mineral-based eco 'coral-sand' recommended for the eco-friendly aquarist seeking the ultimate pest-free, virus-free marine 'coral-sand'. 100% safe and 100% ready to use.



Cross section showing cavities.

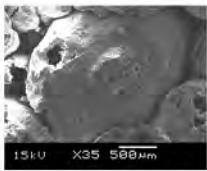

electronic image



electronic image



0.1-3mm large cavity

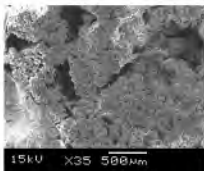

x 35



0-500µm medium cavity

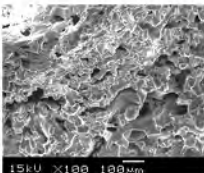

x 100



0.1-10µm micro cavity

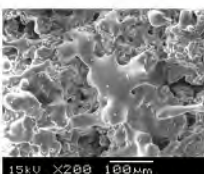

x 200

What are the advantages of RevoReef® 3DM REEF-SAND?

- Environmentally green product. An environmentally friendly alternative which replaces the need to harvest natural coral-sand from coral reefs, preserving them for our future generations.
- Reef Aquarium safe. 100% sterile, virus-free, hitchhiker/pest-free and can be used immediately thus saving time.
- pH Buffer. Buffers pH at 8.1-8.4; suitable for marine fish and corals.
- Rich in minerals and trace elements. Contains essential minerals and trace elements that are important to coral growth and marine fishes. Main elements include CaCO₃, MgCO₃ and Mn.
- Acts as a buffer. Advanced manufacturing technology that slowly release minerals and trace elements thus effectively buffering aquarium water parameters.
- Largest Effective Surface Area. BET Method surface area analysis has determined the effective surface area of RevoReef® 3DM Reef-Sand to be in the range of 1000m² – 2000m²/litre, far surpassing natural coral-sand.

IMPORTANT

3DM Reef-Sand is only for use in Marine aquariums, it must not be used in freshwater aquariums.

INSTRUCTIONS

Please rinse 3DM Reef-Sand before use.



Code No.
RRA0001

Specification
Eco Coral Sand - 5kg (approx. 4L)

Packing
4 bags/carton

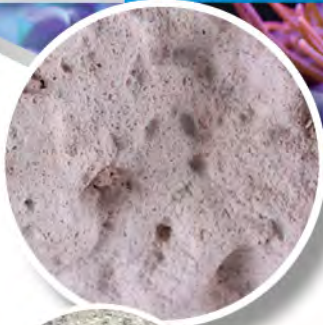

RevoReef®

3DM Reef Rock

Pest Free, Bacteria Free, Parasite Free, Virus Free, Eco Liverock



RevoReef® 3DM Reef-Rock is a revolutionary mineral-based artificial 'live-rock' recommended for the eco-friendly aquarist seeking the ultimate pest-free, bacteria-free, parasite-free, virus-free marine 'live-rock'. 100% safe and 100% ready to use.

3DM® Reef Rock-White



3DM® Reef Rock-Red



3DM® Reef Rock-Coralline Red



Creating your dream scape is easy!



3DM Reef-Rock looks natural after a few months.



OCT 2021



MAR 2022



5 months SPS Corals growth in RevoReef® 3DM Reef-Rock only Reef Tank.

5 months old setup mixed with natural & RevoReef® 3DM Reef-Rock.

RevoReef® 3DM REEF-ROCK

pH	: 8.1 – 8.4
Surface Area/Volume	: 2550m ² /L (effective surface area)
Spatial Aperture Range	: Micro (0.10 - 10µm), Medium (10-500 µm), Large (0.1 – 3mm)

RevoReef® 3DM Reef-Rock is a revolutionary mineral-based artificial 'live-rock' recommended for the eco-friendly aquarist seeking the ultimate pest-free, virus-free marine 'live-rock'. 100% safe and 100% ready to use.



Cross section showing cavities.

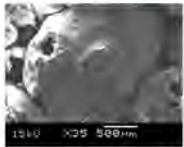

electronic image



electronic image



0.1-3mm large cavity

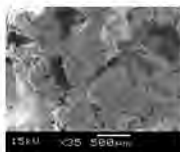

x 35



10-500µm medium cavity

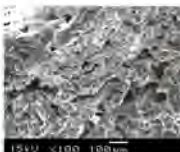

x 100



0.1-10µm micro cavity

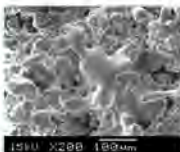

x 200

What are the advantages of RevoReef® 3DM REEF-ROCK?

- Environmentally green product. An environmentally friendly alternative which replaces the need to harvest natural live-rocks from coral reefs, preserving them for our future generations.
- No curing required. 100% sterile, virus-free, hitchhiker/pest-free and can be used immediately thus saving time.
- pH Buffer. Buffers pH at 8.1-8.4; suitable for marine fish and corals.
- Rich in minerals and trace elements. Contains essential minerals and trace elements that are important to coral growth and marine fishes. Main elements include CaCO₃, MgCO₃ and Mn.
- Acts as a buffer. Advanced manufacturing technology that slowly release minerals and trace elements thus effectively buffering aquarium water parameters.
- Tough and Macro-Porous. Advanced manufacturing and high temperature processes has given RevoReef® 3DM Reef-Rocks their distinctive lightweight, tough and porous structure. Within the tough exterior lies 3 dimensional cavities of various spatial apertures (macro, medium and large cavities) all interlinked by micro-tunnels.
- Ideal Conditions for Bacteria. The cavities and interlinked micro-tunnels increase the overall effective surface area and create ideal conditions for billions of Aerobic and Anaerobic Bacteria within a single filter medium.
- Largest Effective Surface Area. BET Method surface area analysis has determined the effective surface area of RevoReef® 3DM Reef-Rocks to be in the range of 1000m² – 2000m²/litre, far surpassing natural live-rocks' effective surface area of 200m² – 500m²/litre.

Creating your dream scape is easy!

- Easy to shape. 3DM Reef-Rocks allows you to create your ideal shape according to individual requirement by filing using a file or create hole by a drill and modify the hole by filing as well. Flat surfaces for Coral frags or more hiding holes? It's your call!
- Form your dream scape. 3DM Reef-Rock is easy to stack, interlock or decorate to form the natural looking reef-scape that you've always wanted!
- Coral and Coralline friendly. 3DM Reef-Rock's unique composition encourages coralline algae to establish on it, especially in matured tank already seeded with coralline algae. In a few months' time it will look exactly like a real live rock.

Code No.

RRA0002
RRA0003
RRA0004
RRA0005
RRA0006
RRA0007
RRA0008
RRA0009
RRA0010

Specification

Red 0.9 - 1.5kg (Small)
Red 1.8 - 2.5kg (Medium)
Red 2.8 - 3.5kg (Large)
White 0.9 - 1.5kg (Small)
White 1.8 - 2.5kg (Medium)
White 2.8 - 3.5kg (Large)
Coralline Red 0.9 - 1.5kg (Small)
Coralline Red 1.8 - 2.5kg (Medium)
Coralline Red 2.8 - 3.5kg (Large)

Packing

9 - 12 Kgs/carton / 72 cartons/pallet
9 - 12 Kgs/carton / 72 cartons/pallet
9 - 12 Kgs/carton / 72 cartons/pallet
9 - 12 Kgs/carton / 72 cartons/pallet
9 - 12 Kgs/carton / 72 cartons/pallet
9 - 12 Kgs/carton / 72 cartons/pallet
9 - 12 Kgs/carton / 72 cartons/pallet
9 - 12 Kgs/carton / 72 cartons/pallet
9 - 12 Kgs/carton / 72 cartons/pallet

REEF START-BACTERIA STARTER

REEFSTART is a scientifically formulated bacteria and enzyme starter to optimize the nitrification and de-nitrification process in both new setups and established marine aquariums.

REEFSTART's quick-start formula ensures nitrifying bacteria establishes quickly in the bio-filtration, and at the same time providing essential enzymes that helps break down toxic organic compounds while the bio-filtration is being colonized. This makes REEFSTART very useful when starting up new filter-systems and maintaining healthy aquariums.

Features and Benefits:

1. Suitable for newly setup and established aquariums.
2. Bacteria count of more than 7.5 billion CFU per ml of liquid.
3. Detoxifies and break-down Ammonia, nitrite, nitrate and organic waste.
4. Fast and effective break down of toxic organic compounds.
5. Extended shelf life guarantees high bacterial count after activation.
6. Increases D.O (Dissolved Oxygen) level in aquarium by reducing C.O.D. Chemical Oxygen Demand and B.O.D Biological Oxygen Demand.
7. Non-pathogenic, environmentally safe.

Code No.	Specification	Packing
RRM0001	125ml	48 bottles/carton
RRM0002	250ml	36 bottles/carton



RRM0002

RRM0001

REEF ESSENCE-MARINE LIFE BOOSTER

REEF ESSENCE is a 100% all-natural mineral extract containing almost all essential elements, minerals and compounds beneficial for marine life, providing a rich source of elements that is almost impossible to cultivate in an enclosed tank system. These elements help marine life (including fish, crustaceans and corals) to optimize their growth, coloration and symbiotic relationships.

Features and Benefits:

1. 100% all-natural Health Booster for all marine life.
2. Clarifies and stabilizes water quality.
3. Reduces stress in fish/crustaceans and promotes growth in corals.
4. Increases appetite, enhances growth and intensifies color of fishes, crustaceans and corals.
5. Boosts immune system of fishes and crustaceans.
6. Helps to remove toxic chemical and heavy metals.

Important Note:

Water will turn cloudy for several hours up to 2 days after REEF ESSENCE is added, but the water will subsequently become crystal clear. Duration of cloudiness is dependent on water quality and filtration. The effect is natural and will not harm any fishes or corals.

Code No.	Specification	Packing
RRM0003	125ml	48 bottles/carton
RRM0004	250ml	36 bottles/carton



RRM0004

RRM0003

NUTRICORE-CORAL GROWTH SUPPLEMENT

NUTRICORE is scientifically formulated to provide all essential vitamins, exotic trace minerals especially absorbable calcium source for zooxanthellae's photosynthetic processes which directly ensures optimal health, growth and vigour in corals, anemones, gorgonians, and desirable marine algae.

Features and Benefits:

1. Provides all essential vitamins, exotic trace minerals especially absorbable calcium source for zooxanthellae's photosynthetic processes which directly ensures optimal health, growth and vigour in corals, anemones, gorgonians, and desirable marine algae.
2. Enhances coral growth and strengthens overall health and immune system.
3. Naturally aids in improving coral coloration.
4. 100% Natural. Do not contain any harmful heavy metal and toxic substances.
5. Does not cloud or pollute the water.
6. Clarifies and stabilizes water condition.

Note:

For best results, alternate use with REVOREEF INTENSE Coral Color Supplement to provide the nutrient variety readily available in their natural habitat.

Code No.	Specification	Packing
RRM0005	125ml	48 bottles/carton
RRM0006	250ml	36 bottles/carton



RRM0006

RRM0005

INTENSE-CORAL COLOR SUPPLEMENT

INTENSE is a formulated Coral color supplement that provides all digestible mono-, di- and oligosaccharides, absorbable fatty acids and glycerine polymers, exotic trace elements, carotenoids complexes and most importantly, all 23 essential amino acids needed for intense coloration, optimal health and growth in corals, anemones, gorgonians, and desirable marine algae.

Features and Benefits:

1. Provide all digestible mono -, di- and oligosaccharides, absorbable fatty acids, exotic trace elements, carotenoids complexes and most importantly, all 23 essential amino acids needed for optimal health, extensive growth and colour vigour in corals, anemones, gorgonians, and desirable marine algae.
2. Naturally intensifies coral coloration.
3. Aids in coral growth and strengthens overall health and immune system.
4. 100% Natural. Do not contain any harmful heavy metal and toxic substances.
5. Does not cloud or pollute the water.
6. Clarifies and stabilizes water condition.

Note:

For best results, alternate use with REVOREEF NUTRICORE Coral Growth Supplement to provide the nutrient variety readily available in their natural habitat.



RRM0008

RRM0007

Code No.	Specification	Packing
RRM0007	125ml	48 bottles/carton
RRM0008	250ml	36 bottles/carton

BIO-RX-HERBAL HEALTH CONDITIONER

BIO-RX is a high performance fish health conditioner specially formulated to boost the immune system of Marine life against any disease state. Made from 100% natural herbal extracts which were carefully extracted to preserve the efficacy and potency of the herbs, BIO-RX is safe for all marine life including corals and has been subjected to intensive tests in collaboration with marine life breeding farms and professional hobbyists.

Coral and Fish Safe

BIO-RX is herbal based and all natural. It is safe for use in aquariums with corals without any side effects.

Features and Benefits:

1. Herbal conditioner that prevents and responds to bacteria disease, parasite attacks, fungal infections and gills-related infections.
2. An effective prophylactic health conditioner that boosts the immune system of Marine life when dosed weekly.
3. Made of 100% natural herbal extracts that is safe for all marine life including corals.
4. Reduces cross-contamination between infected fish and healthy fish.
5. Will not cloud water or affect your tank's water quality.



RRM0010

RRM0009

Code No.	Specification	Packing
RRM0009	125ml	48 bottles/carton
RRM0010	250ml	36 bottles/carton

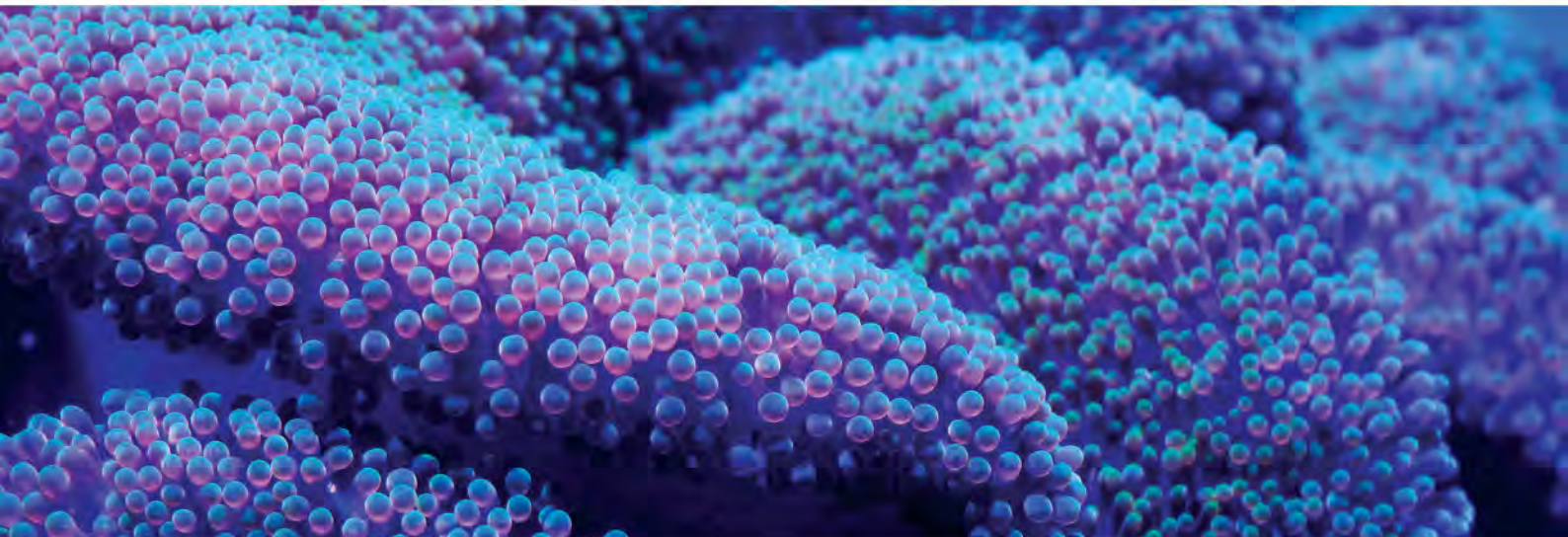

REFRACTOMETER

Provides Accurate Salinity Readings For Marine Aquariums.

RevoReef Refractometer is equipped with Automatic Temperature Compensation (ATS) system. The ambient working temperature of the room must be 20°C (68°F) whenever the instrument is re-calibrated. Once calibrated, shifts in ambient temperature within the acceptable range (10°C - 30°C) should not affect accuracy.

- Provides accurate salinity readings in Specific Gravity (d 2020) and Parts-per-thousand (PPT)
- Automatic Temperature Compensation (ATS)
- Easy-focus adjustable Eyepiece
- For Brackish and Marine aquarium
- Easy to calibrate



Kit Includes



Components

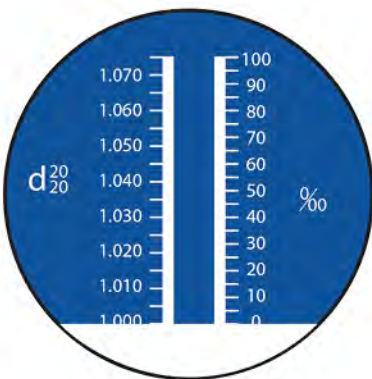

- Step 1. Using the Dropper, place a few drops of the water sample to be tested onto the Prism.
- Step 2. Close the Daylight Diffuser Cover and hold daylight plate in the direction of a light source to check reading. Take the reading of the salinity at the 'refracted line' on the graduated scale.

The reading on the left is for Specific Gravity, right is for PPT (parts per thousand).

Ideal reading for Marine Aquariums	Specific Gravity	Parts Per Thousand (PPT)
Marine Fish Only	1.020 – 1.024	26.5 – 33.1
Coral	1.024 – 1.026	31.8 – 34.5

Code No.
AM052

Description
Refractometer

Specification
31cm x 15.5cm x 14cm

Power Consumption
80W

Packing
25 pieces/carton



仟湖魚業集團
Qian Hu Corporation Limited

www.qianhu.com

**Yi Hu Fish Farm Trading
(Singapore)**

Tel: (65) 6766 7087
Fax: (65) 6764 7077
E-mail: yihufish@qianhu.com

**Qian Hu Marketing Co Ltd
(Thailand)**

Tel: (662) 102 5921
E-mail: qhmkmt@qianhu.co.th

**Qian Hu Aquarium and Pets (M) Sdn Bhd
(Malaysia)**

Tel: 603-8961 5142
Fax: 603-8961 5141
E-mail: sales@qianhu.com.my

P.T. Qian Hu Joe Aquatic Indonesia

Tel: 62-21 8794 2020
Fax: 62-21 8794 3344
E-mail: order@qianhu.co.id

**Guangzhou Qian Hu Aquarium and Pets Co Ltd
(China)**

Tel: 8620-6685 6928
Fax: 8620-6661 5868
E-mail: enquiry@qianhuchina.com

Yi Hu Website : www.yihufish.com
China Website : www.qianhuchina.com



* YI HU reserves the right to alter its products, colours or packaging from those shown in this catalogue.
* All details correct at time of going to press.